

www.cshardware.com
262-375-7960
Order online or by phone today!



Supplying
woodworkers for
45 years!

From the first cut...



pg. 7



pg. 24



pg. 40



pg. 43



pg. 29

pg. 84

pg. 95

pg. 106



to the finishing touch.

All orders placed by 2pm CST will ship same day!

"...and ourselves your servants for Jesus' sake." II Corinthians 4:5b

You have a knack for creating a perfect space. Sometimes that means simply replacing a broken faucet or repairing a crack in a driveway. Other times, you dream of a modern-looking bathroom, a more efficient way to organize the mess of cookware in the kitchen cabinets, or a better way of accessing the highest shelf of the bookcase or pantry.

For over 40 years, Custom Service Hardware has been helping everyone from DIY-minded homeowners to large cabinet shops realize their visions for their homes and projects. We have poured countless hours into creating the best experience for you—providing a wide variety of hardware options, a robust and comprehensive website, the most competitive pricing on the market, informative video guides, and top notch customer service. We'll not only help you find exactly what you need, but also go above and beyond to answer your questions, give you advice, and help you in any other way possible.

CSH will help you take your vision for any project and make it a reality.



Mike Allen, CSH President

WE BELIEVE:

1. That our customers must be given the best possible service.
 2. That we must keep our operating costs as low as possible—to keep your savings as high as possible.
 3. That our business ethics must be consistent with the faith of the owners in Jesus Christ and His Word, the Bible.
- We invite you to write or call our president, Mike Allen. If what we do, does not match what we believe, **we will make it right.**

SHIPPING:

Merchandise will be shipped by UPS ground, SPEE-DEE (where available), FEDEX or common carrier. Most orders are freight pre-paid and charged on invoice.

Freight on orders shipping Ground from Jackson to destinations within the contiguous states will be charged a flat rate of 11% of the total sell price of the order (\$13.60 minimum freight charge). Truckline, COD, USPS and Spee-Dee shipped orders do not apply. The current quoted freight will be charged on these orders.

All hardware items, in stock, are shipped within 24 hours. If not in stock our staff will notify you of the expected delivery time. Out of stock items are placed on back order or alternate items will be suggested.

Shipment Tracking and Notification Supplied Via Internet and e-mail. Items over 96" length will incur an additional charge.

FOR RUSH ORDERS:

Expedited shipping is available upon request at additional cost.

BACK ORDERS:

We do our best to keep adequate supply of merchandise on hand, but we sometimes temporarily run short of an item. Freight on the back ordered items will be billed on the original order.

SHORTAGE & CONCEALED DAMAGES:

Must be reported within 48 hours of receipt.

DAMAGED SHIPMENTS:

You must note damage on the drivers log or delivery receipt, for UPS call for an inspection report.

(Keep original packaging and contents for inspection) 1-800-Pick UPS

Truck Line Shipments: You must have specific damage noted on all copies of the freight bill.

RETURN MERCHANDISE AUTHORIZATION:

Returns accepted within 30 days of order placement. All returned shipments must have a Return Merchandise Authorization (RMA) from Custom Service Hardware before they are returned. A Prepaid Return label will be provided with each RMA. A base 15% restock fee will be subtracted from the amount of all refunds. Unauthorized returns will result in a delay in processing and may be refused. Returns must be clean, in original boxes, un-assembled and in like new, sellable condition. Obsolete, discontinued or clearance items cannot be returned. Original shipping is not refunded. Dropship returns may incur restock fees.

CREDIT

We allow up to 3 weeks to process and issue any credit once return is received and approved.

SPECIAL ORDERS/CUSTOM

Special order products and tools are non-returnable unless goods are determined to be defective under the manufacturer's warranty. Cancellation of special-order products may result in fee.

ORDER INFORMATION:

Telephone toll free, 1-800-882-0009, and talk with one of our friendly, trained staff, and they will assist you in placing your order. Please use part numbers. Use our 24-hour FAX line to send your purchase order, (262) 375-7971. This will minimize your phone time and reduce communication errors. E-mail your orders to service@cshardware.com. Place your order on the web at www.cshardware.com. **Will call** orders should be called in one hour before pick-up to allow adequate time to process orders.

PAYMENT TERMS AND FEES:

COD: Sorry, no C.O.D. orders are accepted. Please use Discover, MasterCard, or Visa.

Credit terms: call or write our credit department (Sales of \$500.00 opening order and \$500.00 per month required for terms). CSH reserves the right to allow or terminate terms. Returned checks are subject to a \$50.00 charge and account terms may be changed to Visa/MC or cash.

Sales Tax: We are required to collect sales tax on orders shipping to any state where Custom Service Hardware has Nexus unless we are provided with a valid exemption certificate.

Purchases made over the Internet or by other remote means are not necessarily exempt from tax in the state where you reside. Many states require residents to pay the use tax to the state tax authorities. For more information and the appropriate forms and instructions, please visit your state's website.

Hazardous material charges will be added to invoice when applicable.

WARRANTY:

All products are produced to standard and commercial tolerances. We warranty products to be free from defects in materials and manufacturing. When we have determined that a product is defective, it will be replaced. At our discretion, a credit may be issued instead of a replacement. **No other warranty is implied, and we will disclaim any implied warranty including merchantability or fitness for a particular purpose.** Proof of purchase is required.

LIABILITY:

The customer shall be responsible for testing and verifying the suitability of the product for intended use. The customer assumes all risk and liability. Our only obligation is to replace or, alternatively, credit for the cost of the product proven defective. We shall not be liable for any other damages, whether incidental, indirect, special, punitive, consequential or otherwise.

DISCLAIMER PLEASE READ!

PRICING INFORMATION:

Prices are subject to change without notice. We make every effort to avoid mistakes in our catalogs. However, should any errors appear, we reserve the right to correct them.

In today's global economy, the price of raw material is constantly changing, which means that some of our pricing is constantly changing as well. We are always working to get the best price for you.

DS = Drop Ship
(ships directly from vendor to customer)

Delivery day maps for shipments from WI:

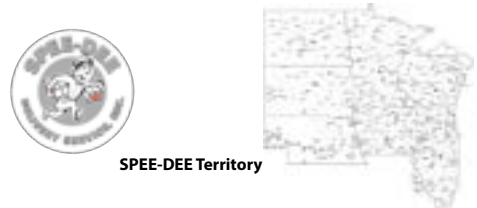

Order online at www.cshardware.com

Call toll-free 800-882-0009 - 8 AM to 5 PM CST, Mon. - Fri.

Fax your order 24 Hours (262) 375-7970 or email your order at service@cshardware.com

Drawer Slides	5	Leg Levelers	53
European Epoxy	5	Grommets.....	53
Undermount Full-Extension Slides	8	Glass Doors/Mirror/Panel Hardware	54
Sidemount Ballbearing	8	Swivel Hardware.....	54
Heavy-Duty Sidemount.....	10	Wall Beds	55
Ballbearing.....	10	Bed Hardware.....	55
Light-Duty Sidemount Ballbearing.....	11	Table Hardware	57
Hinges	12	Office & Media Storage.....	57
Blum AVENTOS Lift Systems	12	Cabinet & Mailbox Locks	58
Decorative Hinges	15	Stealth Lock.....	58
Door Parts & Accessories	16	Brackets & Shelf Supports.....	59
Concealed Hinges	17	Ent. Center Door Hardware	61
Decorative Hardware	25	Floating Shelves.....	62
Cast Metal Pulls & Knobs.....	25	Sliding Door Hardware	63
Decorative Pulls & Knobs.....	26	Sliding Door Hardware.....	63
Wire Pulls.....	28	Foot Rail System.....	65
Jigs & Installation.....	29	Tools	66
Jigs & Handle Installation Guides.....	29	FastCap 3rd Hand.....	68
Steel Arch Pulls	29	Kreg® Products	72
Steel Bar Pulls	29	Pocket Hole Tools	72
Unfinished Wood Knobs	29	Clamps	73
Coat Hooks.....	30	Router & Saw Accessories.....	73
Wood Products	31	Cleaners, Lubricants, & Laminate Supplies	74
Pride Industrial®	31	Cleaners & Lubricants	74
Ornamental®	32	Blades and Bits	75
White River®	33	CMT Oscillating Blades	75
Hardware Resources®	35	Contractor Router Bits.....	76
Ornamental®	32	CMT Hole Saws	76
Arborescence®	36	Freud Circular Saw Blades	77
Edgebanding & Veneer	37	Freud Industrial Router Bits.....	78
Veneer Sheets	37	Bits.....	78
Edgebanding	37	Laminate Tools	79
FastCap Cover Caps	38	Nails and Staples	80
Fastedge.....	38	Nail and Staple Guns	81
Abrasives	39	Senco Staplers & Nailers	82
Abrasives.....	39	General Finishes®	84
Adhesives	41	Water-Based Stains & Paints	84
Glue & Heavy-Duty Adhesive	41	General Finishes®	85
Adhesive & Tapes	42	Water-Based Top Coats & Undercoats	85
Hardware Fasteners	44	Oil-Based Stains & Top Coats.....	85
Hidden Fasteners	44	Accessories.....	86
Inserts.....	44	Wood Treatments	86
Nuts & Washers.....	44	Wood Treatments.....	86
Bolts	44	Blue Bear Concrete Treatments	86
Wall Anchors & Hangers	45	Wood Fillers & Stain Markers	87
Connector Fittings.....	46	Wood Restoration	87
Screws	46	Concrete Restoration	87
Drivers and Driver Bits.....	51	Wood Fillers	87
Senco Staples and Nails	52	Plugs, Dowels & Pegs	88
Furniture Hardware	52	Spaceballs & Synergy Panel Spacers	89

Kitchen Accessories 90

Fillers & Pullouts.....	90
Pullout Pilasters.....	92
Specialty Storage.....	92
Lazy Susans.....	94
Compost Container Pullouts	95
Waste Pullouts	95
Fillers & Pullouts.....	97
Specialty Storage.....	97
Lazy Susans.....	97
Waste Pullouts	98
Filler/Pullouts	99
Specialty Storage	99
None-Slip Mats	99
Kitchen	100
Filler Waste Pullouts	101
Appliance Garage Kits	102
Tambour	102
Specialty Storage.....	102
Cutting Boards & Butcher Blocks	103
Pullouts.....	103
Waste Pullouts	103
Pullout Pilasters.....	103
Wood Range Hoods & Ventilators.....	104
Wood Hoods.....	105

Bathroom, Closet & Laundry Accessories 106

Tie Racks & Belt Organizers.....	107
Closet Rods.....	107
Closet Storage Pullouts	108
Hampers.....	108
Shoe Storage.....	108
Pants Rack.....	108
Closet Rods.....	108
Docking Drawer Blade Series.....	109
Charging Drawer	110
Electronic Accessories	110
Lighting Accessories	110

Lighting 111

Tresco Lighting	111
Under Cabinet Lighting	113
Häfele Loox LED Lighting	114

Drawer Slides

European Epoxy

Allow 7/8" between top of drawer & drawer opening

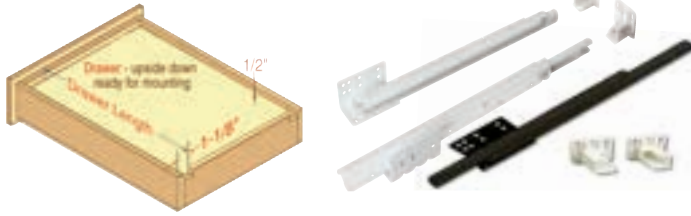

Self-Closing Undermount Concealed Epoxy Drawer Slides

Clearance for this slide is 1 1/4" minus the drawer box thickness. Recommended drawer box thickness is 1/2" - 5/8". Back Sockets are included. 100 lb. capacity.

SKU	Cabinet Min. - Max.	Drawer Length	Set	Price per Each		
				Case Qty	Case	10-Case
White						
330.18.01	16 1/4" - 17 1/2"		\$9.88	20	\$8.82	\$7.68
330.2101B	19 1/4" - 20 1/2"	18"	\$11.25	20	\$9.00	\$8.19
330.24.01	22 1/4" - 23 1/2"	21"	\$10.30	20	\$8.60	\$7.37
Brown						
330.15.07	13 1/4" - 14 1/2"	12"	\$0.99	20	WSL	WSL

Recommended Screws: **0.FPC08058Z** for Cabinet Members, **0.FPC06058Z** for Drawer Members & **0.PPC06058Z** for Back Sockets

Houck Epoxy Self-Closing Slide w/Mounting "L" Brackets

- Quattro captured for accurate tracking
- Roll formed for smooth, quiet roll
- Patented self-adjusting wheels
- Integrated welded brackets
- Slotted and round holes for correct positioning
- Self-Closing
- 1/2" Side Clearance



SKU	Size	Set	Case Qty	Price per Set	
				Case	10-Case
31.950SSL450	18"	\$6.98	10	\$6.40	\$5.90
31.950SSL500	20"	\$8.07	10	\$7.05	\$6.49
31.950SSL550	22"	\$8.07	10	\$7.05	\$6.49

Recommended Screws: **0.PPC08...** or **0.TPC08...**

Houck 500 Series GO-EZ Replacement Kit

- These drawer slides fit a 24" drawer and a 24 1/2" cabinet.
- Easy locating and fastening Universal panel and frame mount
- Quattro captured for accurate tracking
- Roll formed for smooth, quiet roll
- Patented self-adjusting wheels
- Can be trimmed



SKU	Length	Set	Case Qty	Price per Set	
				Case	10-Case
31.500REPKIT	24"	\$11.67	20	\$10.86	\$9.97

Cutting Board Storage Slides



- Non-handed channels easily mount to face frame or frameless cabinets
- Integrated rear V-notch fastening
- Channel accommodates 3/4" cutting board
- Epoxy coated
- **Cutting boards can be found on page 29**

SKU	Length	Set	Case Qty	Price per Set	
				Case	10-Case
31.150BB215	21 1/2"	\$5.86	25	\$5.12	

Hettich Euro Slides, 100 Lb. Load Capacity

- Self Closing
- 32mm Compatible
- Epoxy Coated-White
- Bottom Side Mounted
- 1/2" Side Clearance



SKU	Size	Set	Price per Set	
			Case Qty	Case
H.1061611	10"	\$2.69	20	\$2.15
H.1058344	12"	\$3.99	20	\$3.33
H.1083375	14"	\$2.86	20	\$2.29
H.1074665	14"	Case Only	100	\$2.01
H.1058346	16"	\$2.95	20	\$2.75
H.1056063	16"	Case Only	100	\$2.75
H.1058347	18"	\$3.23	20	\$2.58
H.1056068	18"	Case Only	100	\$2.37
H.1058348	20"	\$7.38	20	\$6.71
H.1056073	20"	Case Only	100	\$2.52
H.1058349	22"	\$7.98	20	\$7.26
H.1056079	22"	Case Only	100	\$2.69
H.1058350	24"	\$3.88	20	\$3.11
320.002	Back Sockets	\$1.59	100	\$1.33

Recommended Screw: **0.FPUC06058Z17...**



Epoxy, Self-Closing Slide, 1.2mm Thickness

Use Undercut Head Screw **0.FPUC06716Z17** (7/16"), **0.FPUC06012Z17** (1/2") or **0.FPUC06058Z17** (5/8"). Euro-screws 6.3mm x 13mm, zinc, fits 5mm hole. Screw length depends on drawer side thickness. 1/2" Side clearance.

SKU	Size	Slide Color	Set	Case Qty	Price per Set	
					Case	10-Case
316.14.07	14"	Brown	\$2.32	100	\$1.62	WSL
316.14.10	14"	Creamy White	\$2.32	100	\$1.62	WSL
316.18.07	18"	Brown	\$2.95	100	\$2.07	WSL

Epoxy Slide Accessories

These back sockets are sold as a set with left and right sockets, and they fit perfectly only with CSH's and Hettich Epoxy Drawer Slides.



Back Socket for Self-Closing Slide

SKU	Description	Size	Price per Pair	
			Pair	100-ct
320.002	Back Socket	3" Length	\$1.59	\$1.33

Recommended Screw: **0.PPC...** or **0.TPC...**



Adjustable Back Socket for Self-Closing Slide

SKU	Description	Size	Price per Pair	
			Pair	100-ct
320.002ADJ	Adjustable Back Socket (Pair)		\$1.67	\$1.49

Recommended Screw: **0.PPC...** or **0.TPC...**



Heavy Duty Back Socket for Self-Closing Slide

SKU	Size	Price per Pair	
		Pair	100-ct
320.002HD	3" Length	\$1.51	\$1.06

Recommended Screw: **0.PPC...** or **0.TPC...**



Back Socket w/o Bottom Flange for Self-Closing Slide

No bottom flange makes these great for bottom drawers.

SKU	Description	Size	Price per Pair	
			Pair	100-ct
34.648SC	Back Socket	2 1/8" Length	\$2.01	\$1.20

Recommended Screw: **0.PPC...** or **0.TPC...**

EXCEL SC SOFT-CLOSE UNDERMOUNT DRAWER SLIDES W/ UP/DOWN ADJUSTMENT



6-way adjustable (4-way up/down and side-to-side through the locking devices included with each set, and 2-way Easy Height Adjustment on the drawer member)

100 lb static load capacity
front clips included

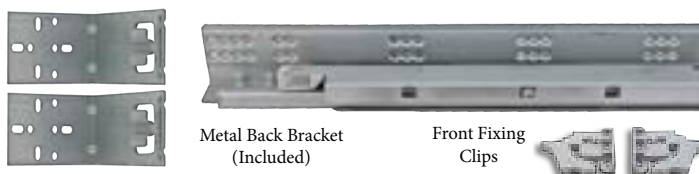

Metal Back Bracket (Included)

Front Fixing Clips

SKU	Drawer Thickness	Price per Set		
		Set	Case Qty	Case
FGV.EXSC1215K6AV	1/2" - 5/8" (12.7mm - 16mm)	\$18.74	5	\$15.65
FGV.EXSC1518K6AV	1/2" - 5/8" (12.7mm - 16mm)	\$21.26	5	\$17.75
FGV.EXSC1821K6AV	1/2" - 5/8" (12.7mm - 16mm)	\$23.70	5	\$19.79
FGV.EXSC2124K6AV	1/2" - 5/8" (12.7mm - 16mm)	\$27.94	5	\$23.29

FGV Universal rear mount socket for FGV EXSC with side to side adjustment

SKU	Each	Case Qty	Case
FGV.G280USH	\$1.34	400	\$1.12
FGV.G308USH	\$1.66	200	\$1.09
FGV.URMS	\$1.09	200	\$ 0.88

For use with FGV.EXSC...[EXCEL SC (Soft-Close Undermount Drawer Slides) Series]

Full Extension Quadro V6 4D **Silent System Slide with 4-Way Adjustability**



Features:

- **Soft-Close** closure is filled with air, so there's no chance of oil leaking into your cabinets.
- **Soft-Close** is designed to silently close at the same speed no matter the weight.
- 100 lb. static load capacity
- Available in 9" to 24" slide lengths



- Ideal for inset drawers with extra adjustability.
- For use with 5/8" drawer box material (or 1/2" material with spacers).
- Left and Right Front Fixing Clips, and Left and Right Tilt Adjusters are required but sold separately.

SKU	Length	Cabinet Depth with Metal Rear Attachment	Price per Set		
			Set	Case Qty	Case
H.9209777	9"	9 7/8" - 11 3/4"	\$33.48	5	\$29.64
H.9209798	12"	12 7/8" - 14 3/4"	\$31.68	5	\$28.00
H.9209799	15"	15 7/8" - 17 3/4"	\$41.85	5	\$34.94
H.9209800	18"	18 7/8" - 20 3/4"	\$36.45	5	\$31.05
H.9209801	21"	21 7/8" - 23 3/4"	\$33.15	5	\$29.06
H.9209802*	24"	24 7/8" (no rear attachment, must be blocked out)	\$42.99	5	\$36.71

Recommended Screw: [0.FPC08058Z...](#)



Front fixing clips
Tilt adjusters
Spacers

Quadro 4D Accessories (required)

SKU	Price per Set		
	Set	Case Qty	Case
H.9218979	\$9.71	10	\$8.28

Recommended Screw: [0.FPC06...](#)

Rear Attachments

H.9055093	\$2.38	10	\$2.17
-----------	--------	----	--------

Economy **Soft-Close Undermount Full Extension Slide**

- Front clips & back socket included
- Full extension
- **Soft-Close**
- 85 Lb. static weight capacity
- Undermount slide

SKU	Length	Cab. Depth	Price per Set			
			Set	Case Qty	Case	10-Case
39.3300.12	12"	12.8" - 14.25"	\$16.83	6	\$13.82	\$13.06
39.3300.15	15"	15.8" - 17.25"	\$17.37	6	\$14.26	\$13.48
39.3300.18	18"	18.8" - 20.25"	\$16.99	6	\$13.94	
39.3300.21	21"	21.8" - 22.25"	\$18.09	6	\$14.85	

Recommended Screw: [0.FPC08...](#)

QUADRO IW21 2D, 21" Full Extension Silent System Slide



Features:

- All Steel Concealed Ball Bearings
- - 100 Pound Static Weight Capacity
- - Full Extension
- - Silent Soft Close System is a drawer dampening system that prevents drawers from slamming shut
- - No Side-to-Side Motion to Prevent Racking
- - Face Frame or Frameless Mounting
- - For Use With 1/2" or 5/8" Thick Drawer Boxes

SKU	Length	Case Qty	Set	Case	10-Case
H.9304260	12"	\$33.72	10	\$28.16	\$24.11
H.9304266	15"	\$32.56	10	\$27.19	\$23.28
H.9304274	18"	\$24.24	10	\$20.24	\$17.34
H.9304282	21"	\$24.76	10	\$20.68	\$17.71

Recommended Screw: [0.FPC08058Z](#)

Rear Attachments

H.9308864	\$3.12	100	\$2.61
-----------	--------	-----	--------

Front Fixing Clip Set for 1/2" or 5/8" Drawer Side Material for Quadro IW21 2D

SKU	Each	Case Qty	Case	Description
H.9306533	\$1.46	999	\$1.21	1/2" side material
H.9306534	\$1.34	999	\$1.12	5/8" side material

Drawer Slide Mounting Tool

Features: Accurate slide positioning with built-in indexing tabs; repeatable results without measuring and marking; versatile for use in cabinets, cases, etc.; reversible to mount slides to cabinet and drawer box; secure for holding slides in place as you work; strong, and lightweight materials for easy handling.



KT.KHI-SLIDE \$29.99

Front Clips



Quadro 4D Front Clips for 5/8" Side Material

SKU	Side	Each	Case Qty	Case
H.9247355	Left	\$2.14	100	\$1.79
H.9247356	Right	\$2.14	100	\$1.79

Recommended Screw: [0.FPC06...](#)



Full Extension TANDEM plus BLUMOTION

- Static load capacity of 100 lbs
- Mounted discreetly beneath the drawer
- Meets or exceeds ANSI/BHMA industry standards
- Permanently lubricated synthetic rollers
- Now available with locking devices with side-to-side adjustment
- 6 Sets per case

5/8" Maximum Drawer Side Thickness

SKU	Length	Cabinet Depth	Price per Set		
			Set	Case	10-Case
B.563H2290B10	9"	10 1 1/2" - 11 2 1/2"	\$36.29	\$30.30	\$25.94
B.563H3050B	12"	12 2 3/32" - 14 1/16"	\$29.01	\$24.22	\$20.74
B.563H3810B	15"	15 2 9/32" - 17 1/16"	\$29.01	\$24.22	\$20.74
B.563H4570B	18"	18 2 9/32" - 20 1/16"	\$29.69	\$24.79	\$21.22
B.563H5330B	21"	21 1 5/16" - 23 1 3/2"	\$30.62	\$25.56	

Frameless (Rear brackets/sockets cannot be used)

B.563.4570B	18"	18 2 9/32"	\$27.99	\$23.37	
B.563.5330B	21"	21 1 5/16"	\$28.89	\$24.12	

Recommended Screw: **0.FPC06...**

3/4" Maximum Drawer Side Thickness

SKU	Length	Cabinet Depth	Price per Set		
			Set	Case	10-Case
B.563F2290B10	9"	10 1 1/2" - 11 2 1/2"	\$37.50	\$31.31	
B.563F3050B	12"	12 2 9/32" - 14 1/16"	\$30.17	\$25.19	
B.563F3810B	15"	15 2 9/32" - 17 1/16"	\$30.17	\$25.19	
B.563F4570B	18"	18 2 9/32" - 20 1/16"	\$30.87	\$25.78	
B.563F5330B	21"	21 1 5/16" - 23 1 3/2"	\$31.76	\$26.52	

Recommended Screw: **0.FPC06...**

Locking Devices for TANDEM plus BLUMOTION 563 & 569 Drawer Runners



SKU	Side	Each	Case Qty	Price per Set	
				Case	10-Case
Standard					
B.T51.1801L	Left	\$1.07	100	\$0.89	\$0.76
B.T51.1801R	Right	\$1.07	100	\$0.89	\$0.76



Vertical Mount Locking Device					
B.T51.1801.20L	Left	\$1.45	300	\$1.21	\$1.03
B.T51.1801.20R	Right	\$1.45	300	\$1.21	\$1.03



Narrow Drawer Locking Device*					
B.T51.0801.20L	Left	\$1.24	100	\$1.04	\$0.89
B.T51.0801.20R	Right	\$1.24	100	\$1.04	\$0.89

*Recommended for inside drawer width of 3 3/4" - 4 7/8"



Standard Locking Device with Side-to-Side Adjustment					
B.T51.1901L	Left	\$2.03	100	\$1.70	\$1.45
B.T51.1901R	Right	\$2.03	100	\$1.70	\$1.45



Vertical Mount Locking Device with Side-to-Side Adjust.					
B.T51.1901.20L	Left	\$2.44	100	\$2.04	\$1.74
B.T51.1901.20R	Right	\$2.44	100	\$2.04	\$1.74



Depth Adjustable Locking Device with Side-to-Side Adjust.					
B.T51.1901.PSL	Left	\$4.59	100	\$3.83	\$3.28
B.T51.1901.PSR	Right	\$4.59	100	\$3.83	\$3.28

Recommended Screw: **0.FPC06***



Drawer and cabinet specifications

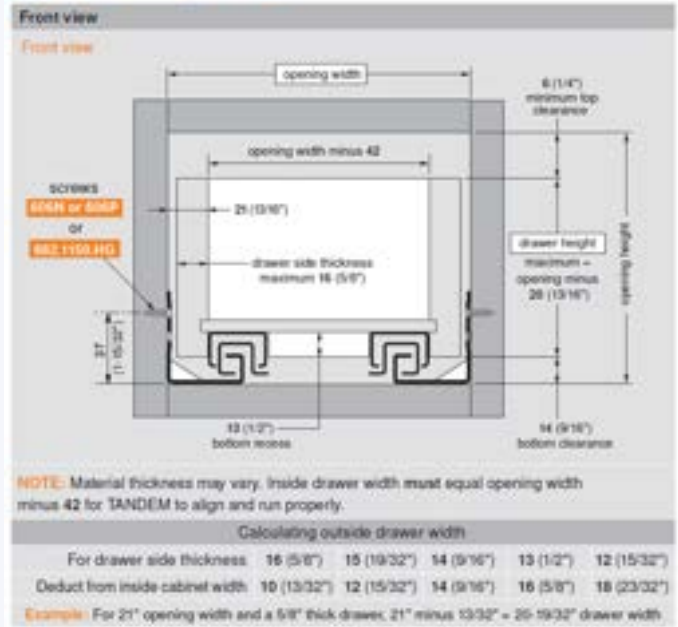

EUROPEAN EPOXY

Accessories



SKU	Type	Each	Case Qty	Price per Case	
				Case	10-Case
Rear Bracket for Frame Cabinets (Not for 9" Slide)					
B.295.3750.03*	Standard	\$0.71	100	\$0.59	\$0.51
B.295.3550.01*	Narrow	\$0.71	100	\$1.03	\$0.88

*Not for Frameless

Required Accessories



Accessory Kit

For use with the T65.1000.02 boring template



High Speed Twist Bit

Standard point, right handed

B.T65.9000

\$38.75

B.DB-2.5MM
B.DB-6MM

2.5mm \$47.12
6mm \$33.65



SKU	Description	Each	Case Qty	Price per Set	
				Case	10-Case
B.T65.1600.01	TANDEM Template	\$61.58		N/A	N/A



B.T59.A5POS	TANDEM Spacer	\$3.45	50	\$2.88	\$2.47
-------------	---------------	--------	----	--------	--------

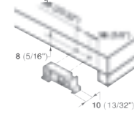

B.T51.7000.01	Rear Mounting Block for Rollout Shelves	\$0.57	250	\$0.45	\$0.39
---------------	---	--------	-----	--------	--------

MOVENTO BLUMOTION 763



- For 5/8" drawer box thickness
- Progressive movement slide
- Sidemount or Bottom Mount
- Frameless or blocked-out face frame cabinets
- Designed to be used with TIP-ON BLUMOTION touch-to-open system
- Inside drawer width must equal the cabinet opening width minus 42mm (1 21/32")
- Left & Right Standard Locking Devices are required (**B.T51.7601** series) but sold separately
- 125 Lb. Static Load Capacity

SKU	Length	Set	Case Qty	Price per Set	
				Case	10-Case
B.763.3050S	12"	\$36.77	6	\$23.18	\$21.73
B.763.3810S	15"	\$36.77	6	\$23.18	\$21.73
B.763.4570S	18"	\$36.77	6	\$23.18	\$21.73
B.763.5330S	21"	\$37.17	6	\$26.31	\$22.58

Recommended Screw: **0.FPC06...**



Standard Locking Device

Left and right sold separately.

SKU	Side	Each	Case Qty	Price per Each	
				Case	10-Case
B.T51.7601L	Left	\$2.00	100	\$1.67	\$1.43
B.T51.7601R	Right	\$2.00	100	\$1.67	\$1.43



Left & Right TIP-ON Unit and Trigger

For use with MOVENTO Runners only

SKU	Drawer Dep.	Capacity	Each
B.T60L7140	12"	0 - 44 lbs	\$25.44
B.T60L7340	15" - 21"	0 - 44 lbs	\$25.44
B.T60L7540	15" - 21"	44 - 88 lbs	\$25.44
B.T60L7570	18" - 24"	88 - 155 lbs	

Narrow Locking Device



This vertical mount locking device for slides with narrow drawers may fit into some applications where the standard one does not fit. Minimum inside drawer width is 3 3/4".

SKU	Side	Each
B.T51.0501.20L	Left	\$2.22
B.T51.0501.20R	Right	\$2.22



TIP-ON BLUMOTION Synchronization Rods

A synchronization rod is recommended for all cabinet widths for optimal function. Cut to size.

SKU	Opening Width	Length	Each
B.T60L1118W	12 3/8"-54 1/2"	44 1/32"	\$6.84

For Narrow Applications

B.T60.300D.22	11 1/16"-12"	2 1/2"	\$1.49
----------------------	--------------	--------	--------



TIP-ON BLUMOTION Front Gap Template

For creating a 1/8" front gap

SKU	Each
B.65.5632.US	\$8.72



TIP-ON BLUMOTION Synchronization Adapter

Two needed per application.

SKU	Each
B.T60.000D	\$0.37

MOVENTO BLUMOTION 769

Heavy Duty Full Extension Drawer Runners

- 170 lb. Static Load Capacity
- 5/8" to 3/4" drawer box thickness
- Frameless or blocked-out face frame cabinets



SKU	Length	Set	Case Qty	Price per Set	
				Case	10-Case
B.769.4570S	18"	\$47.20	6	\$39.41	
B.769.5330S	21"	\$47.64	6	\$39.78	
B.769.6100S	24"	\$54.62	6	\$45.61	
B.769.6860S	27"	\$56.96	6	\$56.96	
B.769.7620S	30"	\$63.98	6	\$53.41	

Recommended Screw: **0.FPC06...**

Sidemount Ballbearing

Full Extension Slides, 100 Lb. Capacity



- Replaces Accuride 3800 & KV 8400
- 32mm hole pattern, metric length
- Non-handed
- 1/2" Side clearance; 1-3/4" height
- Easy lever disconnect
- 100 lb. load rating at 18"
- Clear Chromate finish
- Steel ball bearings

SKU	Length	Set	Case Qty	Price per Set	
				Case	10-Case
HR.303FU08	200mm (7.88")	\$6.70	15	\$6.14	
39.1150.10	250mm (9.84")	\$5.10	15	\$4.15	\$3.15
39.1150.12	300mm (11.81")	\$6.23	15	\$5.06	\$4.65
39.1150.14	350mm (13.78")	\$7.38	15	\$6.00	\$5.50
39.1150.16	400mm (15.75")	\$8.08	15	\$6.56	\$6.02
39.1150.18	450mm (17.72")	\$9.17	15	\$7.45	\$6.84
39.1150.20	500mm (19.69")	\$10.24	15	\$8.32	\$7.63
39.1150.22	550mm (21.65")	\$11.27	15	\$69.16	\$8.40
39.1150.24	600mm (23.62")	\$12.32	15	\$10.01	\$9.18

Rear Sockets

39.1170	Rear Socket, Pair	\$1.49	150	\$1.19	\$0.97
----------------	-------------------	--------	-----	--------	--------

Recommended Screw: **0.TPC08...**

Full Extension Drawer Slides with 1" Over Travel; 100 Lb. Capacity



- 1/2" Side clearance, 1-3/4" height
- 100 Lb. Weight Capacity
- Lever Disconnect for Easy Drawer Removal
- 1" Over Travel
- Bright Zinc Finish

SKU	Drawer Length	Set	Case Qty	Price per Set	
				Case	10-Case
39.1175.08	203mm (8.00")	\$7.32	10	\$6.05	\$5.60
39.1175.10	250mm (9.84")	\$7.27	10	\$6.01	\$5.56
39.1175.12	300mm (11.81")	\$8.21	10	\$6.79	\$6.28
39.1175.14	350mm (13.78")	\$9.54	10	\$7.89	\$7.29
39.1175.16	400mm (15.75")	\$10.79	10	\$8.93	\$8.25
39.1175.18	450mm (17.72")	\$11.92	10	\$9.86	\$9.11
39.1175.20	500mm (19.69")	\$13.16	10	\$10.88	\$10.06
39.1175.22	550mm (21.65")	\$14.34	10	\$11.86	\$10.96
39.1175.24	600mm (23.62")	\$15.85	10	\$13.11	\$12.12
39.1175.26	650mm (25.59")	\$17.42	10	\$14.40	\$13.31
39.1175.28	700mm (27.56")	\$18.81	10	\$15.55	\$14.38

Rear Sockets

39.1175	Rear Socket, Pair	\$2.64	150	\$2.20	\$1.78
39.1145-AP	Adjustable Plate for Rear Socket	\$2.05	150	\$1.67	\$1.53

Recommended Screw: **0.TPC08...**



Full Extension Soft-Close Side Mount

- Full extension
- 100 lb. load capacity
- 1/2" Side clearance; 1-3/4" height
- Long Soft-close stroke of 2 3/8"
- RoHS-compliant zinc plating
- Reinforced slide members
- Quick disconnect
- Recommend Screw **0.TPC08** to attach the front of drawer slide to the face frame or side of the cabinet



SKU	Length	Case Qty	Set	Price per Set	
				Case	10-Case
39.1145.12*	300mm (11.81")	10	\$19.14	\$18.18	\$17.23
39.1145.14*	350mm (13.78")	10	\$17.39	\$14.29	\$13.04
39.1145.16	400mm (15.75")	10	\$18.31	\$15.04	\$13.73
39.1145.18	450mm (17.72")	10	\$19.35	\$15.89	\$14.51
39.1145.20	500mm (19.69")	10	\$20.52	\$16.86	\$15.39
39.1145.22	550mm (21.65")	10	\$21.76	\$17.87	\$16.32
39.1145.24	600mm (23.62")	10	\$23.16	\$19.02	\$17.37
39.1145.26	650mm (25.59")	10	\$24.05	\$19.76	\$18.04
39.1145.28	700mm (27.56")	10	\$25.06	\$20.59	\$18.80
39.1145	Rear Socket	60	\$3.22	\$2.65	\$2.42
39.1145-AP	Adjustable Plate for Rear Socket		\$2.04	\$1.70	\$1.53

Recommended Screw: **0.FPC08...**

*Full Access

Adjustable Plate for Rear Socket



Rear Socket

- Full extension
- 100 lb. load capacity
- 1/2" Side clearance, 1-3/4" height

SKU	Length	Set	Case Qty	Price per Set	
				Case	10-Case
GS.4270.12*	300mm (11.81")	\$17.46	10	\$14.46	
GS.4270.14*	350mm (13.78")	\$17.86	10	\$14.91	
GS.4270.16	400mm (15.75")	\$18.44	10	\$15.4	
GS.4270.18	450mm (17.72")	\$19.42	10	\$16.22	
GS.4270.20	500mm (19.69")	\$20.64	10	\$17.23	
GS.4270.22	550mm (21.65")	\$21.86	10	\$18.25	
GS.4270.24	600mm (23.62")	\$23.22	10	\$19.39	
GS.4270.26	650mm (25.59")	\$24.44	10	\$20.41	
GS.4270.28	700mm (27.56")	\$25.70	10	\$21.46	
GS.4340RB	Back Socket	\$1.44	100	\$1.20	

Recommended Screw: **0.TPC08...**

*Full Access

Drawer Slide Spacers

32mm screw hold centers; Other sizes are available. Screws: 5mm Euro or #6 Slide Screws



SKU	Description	Price per Each	
		Each	100-ct
320.3600.01	1/2" Slide Spacer	\$0.34	\$0.30
320.3601.01	3/4" Slide Spacer	\$0.31	\$0.28
320.3602.01	1" Slide Spacer	\$0.35	\$0.31
320.3604.01	1 1/4" Slide Spacer	\$0.53	\$0.44

Miller Fastblock, Adjustable Spacer Blocks

The Miller FastBlock replaces the commonly used "block of wood in the back of the cabinet" most people use for mounting drawer guides. It is an adjustable drawer guide mounting system for face frame cabinets.

FC.MFB	Miller Fastblock (2 Count)	\$2.40
FC.MFBBULK	Miller Fastblock (100 Count)	\$107.69



FastCap

Full Extension Drawer Slides, 100 Lb. Capacity

- Replaces Accuride 3800 & KV 8400
- 32mm hole pattern
- Side-mount, non-handed
- Adjustable side space tabs
- Steel ball bearings
- Easy lever disconnect
- 100 lb. load rating at 18"
- Exceeds ANSI/BIFMA tests
- 1/2" Side clearance, 1-3/4" height

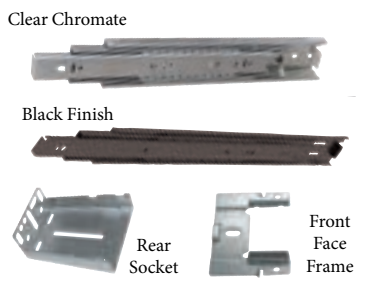

SKU	Length	Set	Case Qty	Price per Set	
				Case	10-Case
Clear Chromate Finish					
39.1170.10	10"	\$7.40	15	\$6.06	\$5.55
39.1170.12	12"	\$10.31	15	\$8.44	\$7.33
39.1170.14	14"	\$11.45	15	\$9.36	\$8.58
39.1170.16	16"	\$12.82	15	\$10.49	\$9.62
39.1170.18	18"	\$14.36	15	\$11.75	\$10.77
39.1170.20	20"	\$16.18	15	\$13.24	\$12.13
39.1170.22	22"	\$17.36	15	\$14.20	\$13.02
39.1170.24	24"	\$19.02	15	\$15.56	\$14.27
39.1170.26	26"	\$20.60	15	\$16.86	\$15.45
39.1170.28	28"	\$23.45	15	\$18.09	\$15.08

Black Finish

PI.4600.10.08	10"	\$5.40	10	\$4.51	\$3.86
PI.4600.12.08	12"	\$6.52	10	\$5.44	\$4.66
PI.4600.14.08	14"	\$7.51	15	\$6.27	\$5.37
PI.4600.16.08	16"	\$8.61	10	\$7.19	\$6.15
PI.4600.18.08	18"	\$9.63	10	\$8.04	\$6.89
PI.4600.20.08	20"	\$10.37	10	\$8.66	\$7.42
PI.4600.22.08	22"	\$11.40	15	\$9.52	\$8.15
PI.4600.24.08	24"	\$12.36	10	\$10.32	\$8.84
PI.4600.26.08	26"	\$13.81	10	\$11.53	\$9.87
PI.4600.28.08	28"	\$14.93	10	\$12.47	\$10.68

Mounting Brackets

39.1170	Rear Socket	\$1.49	150	\$1.19	\$0.97
39.1170.FFB	Front Face Frame	\$1.13	150	\$0.93	\$0.84

Recommended Screw: **0.TPC08...**

Push & Rebound Full Extension, 100 Lb. Capacity

- Lever disconnect
- 1/2" Side clearance, 45.5mm height
- 100 Lb. capacity
- Face frame overlay applications need 3mm of space between the drawer front and the face frame



SKU	Length	Set	Case Qty	Price per Set	
				Case	10-Case
GS.4260.10+	10" (250mm)	\$15.50	20	\$12.94	
GS.4260.12	12" (300mm)	\$16.26	20	\$13.58	
GS.4260.14	14" (350mm)	\$16.74	20	\$13.98	
GS.4260.16	16" (400mm)	\$17.36	20	\$14.50	
GS.4260.18	18" (450mm)	\$18.56	10	\$15.50	
GS.4260.20	20" (500mm)	\$19.50	10	\$16.28	
GS.4260.22	22" (550mm)	\$20.86	10	\$17.42	
GS.4260.24	24" (600mm)	\$22.14	10	\$18.49	
GS.4260.26	26" (650mm)	\$23.46	10	\$19.59	
GS.4260.28	28" (700mm)	\$24.80	10	\$20.71	

Mounting Brackets

GS.4340RB	Back Socket	\$2.86	100	\$2.39	
-----------	-------------	--------	-----	--------	--

Recommended Screw: **0.TPC08...**

*Full Access

MOVENTO BLUMOTION 763

Heavy-Duty Sidemount Ballbearing

Full Extension Drawer Slides



- Replaces Accuride 4032 & KV 8500
- 150 Lb. load capacity
- Release clip for quick disconnect
- 1/2" Side clearance, 3-1/8" height
- Exceeds ANSI/BIFMA
- Clear Chromate finish
- Great for filing drawers

SKU	Length	Price per Set			
		Set	Case Qty	Case	10-Case
39.1200.16	400mm (15.75")	\$19.41	10	\$16.59	\$14.93
39.1200.18	450mm (17.72")	\$21.16	10	\$18.08	\$16.28
39.1200.20	500mm (19.69")	\$22.66	10	\$19.36	\$17.43
39.1200.22	550mm (21.65")	\$25.53	10	\$21.81	\$19.64

Recommended Screw: [0.PPC08...](#)

Titusoft Damper Kit for Wooden Drawers



Features: versatile (one-for-all solution), smooth running with confident soft-close, gray finish.

Includes: one slide addition, one actuator, all required fasteners for one drawer

[TL.973.0M99.380.K2](#) \$5.77

FastCap Drawer Bumper

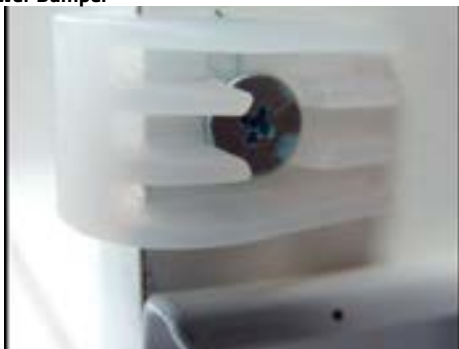

The Drawer Bumper protects cabinet doors from unintentional marring from drawer pull-outs. Peel & stick for instant installation or fasten them with a screw. Screws sold separately.

[FC.DRAWERBUMP](#) 10 Pack \$15.95

Side Mount, Full Extension Slides, 200 Lb. Capacity



- Ball bearing operation
- Heavy duty, 200 lb. load capacity
- Lever disconnect
- 3/4" Side clearance, 2" height

SKU	Size	Case Qty	Price per Set	
			Set	Case
KV.8810B10	10"	4	\$39.98	\$33.38
KV.8810B12	12"	4	\$40.24	\$33.60
KV.8810B14	14"	4	\$42.30	\$35.32
KV.8810B16	16"	4	\$44.28	\$36.97
KV.8810B18	18"	4	\$48.42	\$40.43
KV.8810B20	20"	4	\$54.54	\$43.04
KV.8810B22	22"	4	\$54.52	\$45.52
KV.8810B24	24"	4	\$57.80	\$48.26
KV.8810B26	26"	4	\$60.84	\$50.80
KV.8810B28	28"	4	\$56.44	\$47.13

Recommended Screw: [0.FPC08...](#)

Full Extension Drawer Slides with 1" Over Travel, 130 Lb. Capacity



Over extension drawer slides are a great choice when you need to reach the back of your drawer easily despite an overhanging counter top. This 4932 series drawer slide has a 1" over extension and an easy lever disconnect. 1/2" of side clearance is required.

- 1/2" Side clearance is required, 1-7/8" height

SKU	Size	Set	Case Qty	Price per Set	
				Case	10-Case
39.1180.12	12"	\$9.56	15	\$8.7	\$7.35
39.1180.14	14"	\$10.16	15	\$8.68	\$7.81
39.1180.16	16"	\$11.30	15	\$9.66	\$8.69
39.1180.18	18"	\$13.02	15	\$11.13	\$10.02
39.1180.20	20"	\$14.08	15	\$12.07	\$10.84
39.1180.22	22"	\$18.23	10	\$14.74	\$12.56
39.1180.24	24"	\$16.98	10	\$14.36	\$13.06
39.1180.26	26"	\$17.82	10	\$15.08	\$13.71
39.1180.28	28"	\$23.03	10	\$18.42	\$15.38

Mounting Brackets

39.1170	Rear Socket, Pair	\$1.49	150	\$1.19	\$0.97
-------------------------	-------------------	--------	-----	--------	--------

Recommended Screw: [0.TPC08...](#)

Full Extension Lock-In, Lock-Out Heavy-Duty Drawer Slides, 450 Lb. Capacity



- Stainless steel ball bearing
- Non-handed
- Non-disconnect
- Zinc-plated cold rolled steel
- 1/4" Button head screws
- Side clearance: 19.5 - 20mm
- 3/4" Side clearance, 3" height
- Lock-in mechanism

SKU	Size	Set	Case Qty	Price per Set		SKU	Size	Set	Case Qty	Price per Set	
				Case	Case					Case	Case
FL.FR5400.L.18	18"	\$110.42	4	\$92.20		FL.FR5400.L.38	38"	\$152.12	4	\$126.56	
FL.FR5400.L.20	20"	\$127.22	4	\$106.23		FL.FR5400.L.40	40"	\$204.96	4	\$171.14	
FL.FR5400.L.22	22"	\$123.76	4	\$103.34		FL.FR5400.L.42	42"	\$213.62	4	\$178.37	
FL.FR5400.L.24	24"	\$114.00	4	\$85.55		FL.FR5400.L.48	48"	\$258.22	4	\$215.61	
FL.FR5400.L.26	26"	\$109.64	4	\$91.38		FL.FR5400.L.60	60"	\$316.46	4	\$264.24	
FL.FR5400.L.28	28"	\$129.89	4	\$116.60							
FL.FR5400.L.30	30"	\$166.66	4	\$139.16							
FL.FR5400.L.32	32"	\$176.14	4	\$147.08							
FL.FR5400.L.34	34"	\$185.44	4	\$154.84							
FL.FR5400.L.36	36"	\$187.14	4	\$156.26							

Light-Duty Sidemount Ballbearing

Medium-Duty Stainless Steel Side Mount, Full Extension, 75 Lb. Capacity



- Anti-corrosive stainless steel construction
- Telescopic full extension design
- Ball bearing operation
- 1/2" Side clearance, 45.2mm height
- Lever disconnect
- Screws are included

SKU	Size	Case Qty	Price per Set	
			Set	Case
KV.6400P.SS.10	10"	10	\$41.34	\$34.52
KV.6400P.SS.12	12"	10	\$44.50	\$37.16
KV.6400P.SS.14	14"	10	\$47.96	\$40.05
KV.6400P.SS.16	16"	10	\$52.04	\$43.45
KV.6400P.SS.18	18"	10	\$56.44	\$47.13
KV.6400P.SS.20	20"	10	\$60.82	\$50.78
KV.6400P.SS.22	22"	10	\$62.10	\$51.85
KV.6400P.SS.24	24"	10	\$66.68	\$55.68
KV.6400P.SS.26	26"	10	\$71.02	\$59.30
KV.6400P.SS.28	28"	10	\$74.40	\$62.12

Stainless Steel Side Mount, **Soft-Close**, Full Extension, Up to 81 Lb. Capacity



The ESR-SC4513 series is the newest stainless steel, soft-close drawer slide on the market. Transform your outdoor kitchens with this high-end drawer slide. In addition to soft-close, this series features front disconnect and a 70 to 80 lb. weight capacity. 1/2" Side clearance, 45mm height.

SKU	Length	Lb. Capacity	Price per Set			
			Set	Case Qty	Case	10-Case
SA.ESR-SC4513-16	400mm (15 3/4")	81 Lbs.	\$46.08	10	\$33.46	\$30.67
SA.ESR-SC4513-18	450mm (17 23/32")	79 Lbs.	\$49.92	10	\$35.64	\$32.67
SA.ESR-SC4513-20	500mm (19 11/16")	77 Lbs.	\$53.76	10	\$37.82	\$34.67
SA.ESR-SC4513-22	550mm (21 11/16")	75 Lbs.	\$56.64	10	\$40.73	\$37.34
SA.ESR-SC4513-24	600mm (23 5/8")	73 Lbs.	\$60.48	10	\$42.91	\$39.34
SA.ESR-SC4513-26	650mm (25 3/8")	70 Lbs.	\$63.36	10	\$45.82	\$42.00
SA.ESR-SC4513-28	700mm (27 9/16")	68 Lbs.	\$75.60	10	\$48.00	\$44.00

Low Profile Full Extension **Soft-Close** File or Box Slide

- Side mount
- Lever disconnect
- Low profile
- Zinc
- 65 Lb. capacity
- 1/2" Side clearance, 1-3/8" height



SKU	Length	Price per Set		
		Set	Case Qty	Case
KV.4450B.10*	250mm (9.84")	\$16.58	10	\$13.58
KV.4450B.12	300mm (11.81")	\$16.94	10	\$14.14
KV.4450B.14	350mm (13.78")	\$17.26	10	\$14.41
KV.4450B.16	400mm (15.75")	\$17.84	10	\$14.90
KV.4450B.18	450mm (17.72")	\$18.80	10	\$15.70
KV.4450B.20	500mm (19.69")	\$19.96	10	\$16.67
KV.4450B.22	550mm (21.65")	\$21.18	10	\$17.69
KV.4450B.24	600mm (23.62")	\$22.44	10	\$18.74

Mounting Brackets			
KV.4101B	Back Socket	\$1.56 (Each)	

Recommended Screw: 0.TPC08...

*Full Access

Centermount Drawer Slides



- Glide tacks and rear mounting bracket included to adjust to cabinet depth
- Slide concealed under the drawer, 9.5mm clearance needed
- Quick disconnect, friction fit (pulls apart)
- 40 per case
- Mounting under drawer
- 3/4 Extension
- 35 Lb. load capacity

SKU	Slide (L)	Drawer (L)	Cabinet Depth	Slide Travel	Price per Each		
					Each	Case	10-Case
UF.3508.12	324mm	270 - 318mm	330 - 368mm	224mm	\$7.45	\$6.25	
UF.3508.14	375mm	321 - 368mm	381 - 419mm	271mm	\$5.48	\$4.58	\$4.25
UF.3508.16	425mm	372 - 419mm	432 - 470mm	310mm	\$5.77	\$4.82	\$4.47
UF.3508.18	476mm	422 - 470mm	483 - 521mm	320mm	\$7.34	\$6.73	\$6.24
UF.3508.20	527mm	473 - 521mm	533 - 572mm	393mm	\$6.37	\$5.32	\$4.93
UF.3508.22	578mm	524 - 572mm	584 - 622mm	424mm	\$6.74	\$5.62	\$5.22

Recommended Screw: 0.TPC06...

Low Profile Full Extension Ball Bearing, 35mm Height



- Full extension
- 75 Lb. capacity
- Side-mounted
- Non-handed
- Adjustable side tabs
- Easy disconnect
- 32mm hole pattern
- 1/2" Side clearance
- 1-3/8" Height

SKU	Length	Price per Set			
		Set	Case Qty	Case	10-Case
39.1130.12	300mm (11.81")	\$5.28	10	\$4.41	\$3.78
39.1130.14	350mm (13.78")	\$5.99	10	\$5.00	\$4.28
39.1130.16	400mm (15.75")	\$6.69	10	\$5.59	\$4.79
39.1130.18	450mm (17.72")	\$7.41	10	\$6.18	\$5.30
39.1130.20	500mm (19.69")	\$8.11	10	\$6.78	\$5.80
39.1130.22	550mm (21.65")	\$9.00	10	\$7.51	\$6.43
39.1130.24	600mm (23.62")	\$9.74	10	\$8.13	\$6.97
39.1130.28*	700mm (27.56")	\$11.51	10	\$9.61	\$8.23

Mounting Brackets					
39.1130	Back Socket	\$1.68	200	1.41	\$1.21

Recommended Screw: 0.TPC06...

*Recommended Screw: 0.TPC08...



Keyboard Tray Slides

- 50 Lb. load capacity
- Lock-in and lock-out capability
- Wood screws not included
- Includes (4) reversible mounting brackets & (4) screws per set
- 1 17/32" Outboard position side clearance
- 1 1/6" Inboard position side clearance
- Allows for height adjustment (2 1/2" - 3 3/4") to fit a variety of keyboards

SKU	Length	Load Cap.	Price per Set			
			Set	Case Qty	Case	10-Case
39.1160.16.08	16"	50 Lbs.	\$13.79	20	\$11.04	\$7.90
39.1160.18.08	18"	50 Lbs.	\$12.77	20	\$10.21	\$8.53

Recommended Screw: 0.TPC06...



AVENTOS Lift Systems



- Effortless Opening
- BLUMOTION Soft-Close
- Numerous Design Options
- Fast, Precise Installation

Easily order your AVENTOS lift systems online at www.cshardware.com/blum-aventos.

Blum AVENTOS Lift Systems

Blum Aventos lift systems are an innovative cabinet hinge solution which allows cabinet doors to easily lift up for convenient access to items inside, without disrupting your work in the kitchen. A great feature of these lift up cabinet door hinges is that they feature the BLUMOTION mechanism. Aventos cabinet door lifts are available in several design options for wooden cabinet doors, five-piece doors, as well as aluminum frame doors.

Due to the complex weight differences between cabinets, there is no one-size-fits-all solution for AVENTOS installation components. However, once you understand the options available and the different requirements, ordering your complete AVENTOS package is easy, using our online calculator and ordering form at cshardware.com/blum-aventos.

If you prefer to order the AVENTOS lift systems through the phone, call our experienced sales staff at **1-800-882-0009**. Please have your **door type, weight, and dimensions** available when you call!



HF Bi-Fold Lift System
 Height Range: 18" to 42"
 Width Range: 15" to 72"
 Application: Medium wall cabinets, tall wall cabinets
 Starting at: **\$180.64**



HS Up and Over Lift System
 Height Range: 13" to 32"
 Width Range: 15" to 72"
 Application: Medium wall cabinets, tall wall cabinets
 Starting at: **\$213.36**



HK top Stay Lift System
 Height Range: 10" to 24"
 Width Range: 15" to 72"
 Application: Small wall cabinets, medium wall cabinets, above refrigerator cabinets
 Starting at: **\$101.79**



HK-S Stay Lift System for Small Cabinets
 Height Range: 7 3/8" to 24"
 Width Range: 15" to 72"
 Application: Small wall cabinets, above refrigerator cabinets
 Starting at: **\$48.43**



HL Lift Up System
 Height Range: 11" to 23"
 Width Range: 15" to 72"
 Application: Small wall cabinets, medium wall cabinets, appliance/garage cabinets
 Starting at: **\$219.39**

AVENTOS HK-XS Lift Mechanism - for use with BLUMOTION hinges

The AVENTOS HK-XS Lift Mechanism is one of our hot-sellers and offers a high level of design freedom for small top wall cabinets, thanks to its narrow style. Cabinets with low internal depths can be equipped easily above the kitchen stove or above the bathroom sink. The symmetrical lift mechanism can be used on one or two sides. When used on both sides, even larger, heavier fronts are possible.



Part #	Description	Power Factor*	Each
B.20K1101	Lift Mechanism	17 - 60	\$18.72
B.20K1301	Lift Mechanism	61 - 112	\$18.72
B.20K1501	Lift Mechanism	113 - 156	\$18.72

Required Accessories

B.20K4101	Door Mounting Plate, Screw On	\$0.96
B.20K4501	Door Mounting Plate (Front-Fixing)*	\$4.49
B.20K5101	Frameless Cabinet Mounting Plate	\$1.31
B.20K5501	Face Frame Cabinet Mounting Plate	\$4.77

Contact CSH for assistance selecting correct power factor

*Front-fixing for larger overlay/five-piece doors

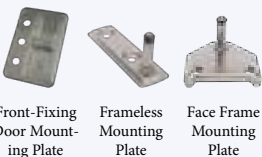

Lid Stays



Soft Close with Lift Assist Lid Stay

- Lapcon Stay for Upward-Opening Flap Doors
- Door Stays in Desired Position
- Simple Installation by Aligning Body to Edge of Cabinet Frame
- Can be Installed Individually or in Pairs
- Damper Equipped for Soft & Silent Closing
- Lift-Assist allows Light Opening



SKU	Side	Torque Rating	Torque Calc.	Each
Heavy-Duty				
SA.SLS-ELAN-HL	Left	65-87 lbs/in	Door H x 1/2 x W	\$72.50
SA.SLS-ELAN-HR	Right	65-87 lbs/in	Door H x 1/2 x W	\$72.50
Medium-Duty				
SA.SLS-ELAN-ML	Left	45-65 lbs/in	Door H x 1/2 x W	\$72.50
SA.SLS-ELAN-MR	Right	45-65 lbs/in	Door H x 1/2 x W	\$72.50

Soft Close with Lift Assist Lid Stay For Swing Lift-Up Doors

- Lapcon Stay for Swing Lift-Up Doors
- Door Stays Open in any Desired Position
- Soft & Silent Closing
- No Hinges Required
- Lift-Assist for extra light-opening
- Simple Installation
- Connecting Bar Sold Separately
- Recommended Door Size:
Max Width: 59"
Height: 15 3/8" - 19 11/16"



SKU	Weight Rating	Each
Heavy-Duty		
SA.SLU-ELAN-H4	20.9 to 24.2 lbs	\$298.08
Medium-Duty		
SA.SLU-ELAN-M4	17.6 to 20.9 lbs	298.08
Light-Duty		
SA.SLU-ELAN-L4	14.3 to 17.6 lbs	\$298.08
SA.SLU-ELAN-S4	11 to 14.3 lbs	\$298.08

Downward Opening Stay, Non-Handed, Black



- For Downward-Opening Lids (Bureaus, Buffets, Wine Glass Cabinets)
 - Holds Door in Fully Closed Position
 - Recommended Door Thickness: 20mm (25/32")
 - Applicable Torque Range: 35 ~ 50 kg-cm (30 ~ 43 lbs-inch) per piece or 70 ~ 100 kg-cm (60 ~ 86 lbs-inch) per pair (torque rating = lid height x lid weight x 1/2)
- SA.SDS-C100/BLK \$18.88

Connecting Bar for SA.SLU-ELAN** Products

Aluminum Bar Only

SKU	Cabinet Opening Width	Price
SA.ELB-480	22 1/4" Width	\$13.60
SA.ELB-780	34 1/8" Width	\$18.08
SA.ELB-1080	45 7/8" Width	\$27.20
SA.ELB-1380	57 3/4" Width	\$34.64

Lid Stay Sold Separately

Non-Handed, Fixed Tension Lid Stay



SKU	Description	Case Qty	Price per Each	
			Each	Case
54.361909	Polished Brass, 6.75" x .75"	100	\$4.19	\$3.84

Recommended Screws: (Four) 0.FPC06058PB...

Non-Handed, Adjustable Tension Lid Stay



SKU	Description	Case Qty	Price per Each	
			Each	Case
54.161909	Brass Color, 6.75" x .75"	100	\$4.19	\$3.84

Recommended Screws: (Four) 0.FPC06058PB...

Lid Supports



Breaking Lift Support, Chrome

- Includes soft-close feature
- Ideal for storage boxes & chests
- For lids up to 20" wide
- Non-handed, side-mounted
- Adjust tension for weight variance
- Supports up to 10 lbs. per pair
- 9 1/2" Long
- Lifts 200mm to 290mm

SKU	Case Qty	Price per Each	
		Each	Case
54.850	25	\$9.89	\$8.33

Recommended Screws: (2) 0.FPC06... & (2) 0FPC04...



Gas Spring Pneumatic Stay

To calculate which Pneumatic Stay* is right for your job (to get correct stay and number of stays:
F=6xWxH divided by 1,000

- **F** = Closing Force
- **W** = Weight of lid (2.2 lbs per KG)
- **H** = Height of lid in MM(25.4 MM per Inch) *If two Pneumatic Stays are used, divide F by 2

SKU	Closing Force	Each
54.SGS800.6	13 lbs	\$10.99
54.SGS800.8	17 lbs	\$10.99
54.SGS800.10	22 lbs	\$15.12

Extended Length of 11"

Lid Stay/Flap Stay

- Adjustable Tension
- 1-3/4" Minimum Frame Width
- Easy Installation
- For Left or Right Side Application
- Holds Door at any Angle
- Screws are Included



10-1/6" Minimum Cabinet Height
HA.373.66.612 Duo Stay, Nickel Finish \$13.55

13-3/8" Minimum Cabinet Height
HA.373.66.632 Duo Forte Stay, Nickel Finish \$19.55

Toy Box Closure

- To calculate the correct spring for your job, multiply one-half the distance (in inches from front to back) times the weight (in lbs.) of the lid.
- Copper Finish
- Recommended Screws: 0.PPC08... or 0.TPC08...

SKU	Spring Color	Force Range IN/LB	Case Qty	Price per Each	
				Each	Case
54.53	Gray	20 - 35	250	\$7.10	\$6.10
54.58	Blue	35 - 40	250	\$6.85	\$5.65
54.57	Green	40 - 45	250	\$8.20	\$7.50
54.59	Maroon	45 - 55	250	\$7.10	\$6.10
54.55	Black	55 - 65	250	\$7.50	\$6.82
54.55D*	Black	55 - 65	250	\$3.80	\$3.59
54.54	Yellow	65 - 95	250	\$6.99	\$5.99
54.56	Orange	95 - 125	250	\$6.99	\$5.99
54.52	White	110 - 140	250	\$6.99	\$5.99

*With Delrin Washer

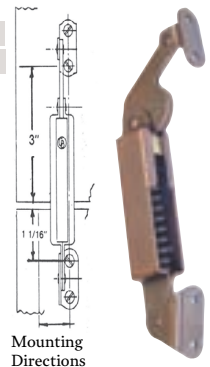

Schaub & Company
Solid Brass Hinges

Mortise / Non-Mortise Hinge

Matching Screws Included



SKU	SC.1111B-*	SC.1100B-*	SC.1100M-*
Type	Mortise	Non-Mortise	Non-Mortise
Leaf	2" x 1-3/4"	2" x 1-1/2"	2" x 1-1/2"
Finial	Ball	Ball	Minarette
Each	\$15.30	\$15.30	\$15.30

*Specify finish color

Classic Brass
Solid Brass & Plated Steel Hinges

Mortise / Non-Mortise Hinge

Matching Screws Included



Type	Mortise	Mortise	Non-Mortise	Non-Mortise	3/8" Offset	3/8" Offset	Mortise	Mortise	Non-Mortise	Non-Mortise
SKU	CB.2501*	CB.2505*	CB.2511*	CB.2512*	CB.2541*	CB.2542*	CB.2571*	CB.2572*	CB.2581*	CB.2582*
Leaf	2" x 1 3/4"	2" x 1 3/4"	2 1/2" x 1 1/2"	2 1/2" x 1 1/2"	2" x 3/8" Offset	2" x 3/8" Offset	2" x 1 5/8"	2" x 1 5/8"	2 1/2" x 1 7/16"	2 1/2" x 1 7/16"
Build	Plated Steel	Plated Steel	Plated Steel	Plated Steel	Plated Steel	Plated Steel	Solid Brass	Solid Brass	Solid Brass	Solid Brass
Finial	Ball	Flush	Ball	Minarette	Ball	Minarette	Ball	Minarette	Ball	Minarette
Per Hinge*	\$11.34	\$11.34	\$12.15	\$13.77	\$13.77	\$13.77	\$17.01	\$17.01	\$17.01	\$17.01
Per Hinge*	\$13.77	\$13.77	\$14.58	\$14.58	\$16.20	\$16.20	\$19.44	\$19.44	\$19.44	\$19.44
Per Hinge*	\$17.01	\$17.01	\$17.82	\$17.82	\$20.25	\$20.25	\$24.30	\$24.30	\$24.30	\$24.30

*Specify finish color using color-coded guide below



Belwith Keeler Steel
Non-Mortise Hinge with
Decorative Finial

Sold in pairs. Screws are included.

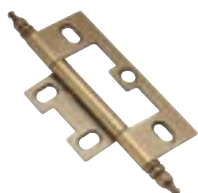

SKU	Size	Finish	Each
HH.P8293-AB	2 1/2" H x 1 1/2" W	Antique Brass	\$8.01
HH.P8293-SM	2 1/2" H x 1 1/2" W	Silver Medallion	\$8.01
HH.P8294-AB	2" H x 1 3/8" W	Antique Brass	\$8.01
HH.P8294-SM	2" H x 1 3/8" W	Silver Medallion	\$8.01

Sold in pairs. 10 pairs per case. Screws are included.



Standard Non-Mortise Hinge,
Two Sizes

Basic hinge with no finials. Sold as each. Screws not included.

SKU	Size	Finish	Each
54.03205.05	2 1/2" H x 1 1/2" W	Stat. Bronze	\$0.67

Recommended Screws: 0.FPC05058B...

SKU	Size	Finish	Each
54.03500.03	2" H x 1 3/8" W	Ant. Brass	\$0.48
54.03500.04	2" H x 1 3/8" W	Zinc	\$0.40
54.03500.06	2" H x 1 3/8" W	Pol. Brass	\$0.40

Recommended Screws: 0.FPC04058...



One Hole

Non-Mortise Partial
Wrap Hinge with
Minarette Finial

Designed to be flush with 3/4" thick cabinet doors. Wrapped edges measure 3/4" on face frame and 3/4" on door edge.

2 1/4" Height x 3/4" Frame x 3/4" Door Flush

SKU	Finish	Price per Each		
		Each	Case Qty	Case
54.70.03	Antique Brass	\$1.96	100	\$1.42
54.70.09B	Brushed Nickel	\$1.37	100	\$1.28
54.70.08M	Matte Black	\$1.78	100	\$1.63

Recommended Screws: 0.FPC05012PB... or 0.FPC05058PB...

Decorative Hinges

By using decorative hinges on your kitchen cabinets, you'll add a unique and functional element that will enhance your kitchen's style and design. Shop our collection of decorative hinges and add a unique look to your kitchen cabinets!



Polished Chrome

3/8" Inset, Semi-Concealed, Self-Closing Hinge

Sold as a pair. Screws included.

Amerock	Finish	Pair Price
AM.3428-26	Polished Chrome	\$6.23
AM.3428-3	Polished Brass	\$6.23
AM.3428-BB	Burnished Brass	\$3.89
AM.3428-FB	Flat Black	\$6.23
AM.3428-G10	Satin Nickel	\$6.23
AM.3428-GB	Gilded Bronze	\$6.23
AM.3428-ORB	Oil Rub Bronze	\$6.23
AM.3428-WN	Weathered Nickel	\$6.23

Belwith Keeler	Finish	Pair Price
HH.P243-AC	Antique Copper	\$4.53
HH.P243-BI	Black Iron	\$5.18
HH.P243-CLX	Chromolux	\$4.28
HH.P243-SBZ	Satin Bronze	\$4.04
HH.P243-SN	Satin Nickel	\$5.18
HH.P243-VP	Vibra Pewter	\$5.18
HH.P243-WOA	Windover Ant.	\$4.53



Economy 3/8" Inset, Semi-Concealed, Self-Closing Hinge

Sold as each. Screws not included.

SKU	Finish	Price per Each	
		Each	100
54.04.03	Antique Brass	\$0.80	\$0.64
54.04.06	Polished Brass	\$1.10	\$0.96
WSL 54.04.09B	Brushed Nickel	\$1.38	\$1.10

Recommended Screws: 0.FPC05058... or 0.OPC05058...

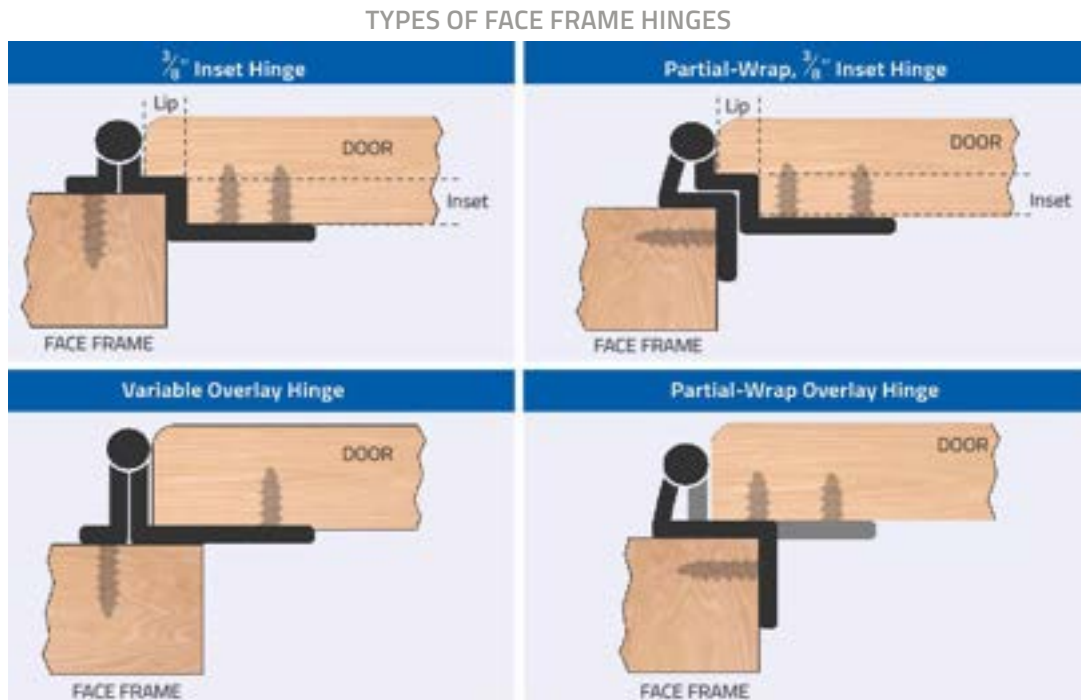

Economy 1/4" Overlay, Partial-Wrap, Self-Closing Hinge

Sold as each. Screws not included. Three screws needed per door and two screws per frame.

SKU	Finish	Price per Each	
		Each	100
54.40.03	Antique Brass	\$1.09	\$0.96
54.40.08	Black	\$1.58	\$1.12
54.40.09B	Brushed Nickel	\$1.74	\$1.49

Recommended Screws: (Three): 0.FPC06... (Two): 0.PPC08...

(Two): 0.PPC08...



Economy 1/2" Overlay, Partial-Wrap, Self-Closing Hinge

Three screws needed per door and two screws per frame. Sold as each. Screws not included.

SKU	Finish	Price per Each	
		Each	100
54.401.03	Antique Brass	\$0.95	\$0.76

Recommended Screws: (Three): 0.FPC06058... (Two): 0.FPC08058... or 0.TPC08058...

(Two): 0.FPC08058... or 0.TPC08058...



Variable Overlay, Semi-Concealed Self-Closing Hinge

Sold as a pair. Screws included.

Amerock	Finish	Pair Price
AM.3429-3	Polished Brass	\$6.23
AM.3429-BB	Burnished Brass	\$5.19
AM.3429-FB	Flat Black	\$6.23
AM.3429-G10	Satin Nickel	\$6.23
AM.3429-ORB	Oil Rub Bronze	\$6.23
AM.3429-W	White	\$6.23
AM.7139-BK	Black	\$4.77
AM.7139-R3	Rustic Brass	\$4.77
AM.7139-WI	Wrought Iron	\$5.81

Belwith Keeler	Finish	Pair Price
HH.P244-AC	Antique Copper	\$5.18
HH.P244-BI	Black Iron	\$5.18
HH.P244-CLX	Chromolux	\$5.18
HH.P244-SBZ	Satin Bronze	\$5.18
HH.P244-SN	Satin Nickel	\$5.18
HH.P244-VP	Vibra Pewter	\$5.18
HH.P244-WOA	Windover Ant.	\$5.18



Economy Variable Overlay, Self-Closing Hinge

Sold as each. Screws not included.

SKU	Finish	Price per Each	
		Each	100
54.01.03	Antique Brass	\$1.00	\$0.84
54.01.06	Polished Brass	\$0.71	\$0.57

Recommended Screws: 0.FPC05058... or 0.OPC05058...



Double-Locking Bi-Fold Hinge, Black*

*Not intended for platforms.

SKU	Description	Price per Each	
		Each	100-ct
54.BF.08	2 3/8" x 2 1/16"	\$4.13	\$3.52

Recommended Screws: 0.FPC06058B...

Hinges



Youngdale Non-Wrap Hinge for Inset and Overlay Applications

American-made Youngdale hinges are for overlay and 3/8" inset cabinet doors, and are cost-effective alternatives to European hinges. They are also easier to install! 4 screws and 1 bumper included with each hinge.

SKU	Size	Price per Each		
		Each	Case Qty	Case
#3, 1/4" Overlay		Each	100-Ct	Case
54.103.03*	Antique Brass	\$3.47	2.82	400 \$2.40

*For doors less than 5/8" thick

SKU	Finish	Price per Each		
		Each	Case Qty	Case
#4, 3/8" Inset		Each	100-Ct	Case
54.104.01	White	\$4.51	\$3.67	400 \$3.12
54.104.02	Chrome	\$3.25	\$2.64	400 \$2.25
54.104.03	Antique Brass	\$3.47	\$2.82	400 \$2.40
54.104.07	Oil Rub Br.	\$3.47	\$2.82	400 \$2.40

SKU	Finish	Price per Each		
		Each	Case Qty	Case
#5, 1/4" Overlay		Each	100-Ct	Case
54.105.01	White	\$4.51	\$3.67	400 \$3.12
54.105.02	Chrome	\$3.25	\$2.64	400 \$2.25
54.105.03	Antique Brass	\$3.47	\$2.82	400 \$2.40
54.105.07	Oil Rub Br.	\$3.47	\$2.82	400 \$2.40

SKU	Finish	Price per Each		
		Each	Case Qty	Case
#6, 1/2" Overlay		Each	100-Ct	Case
54.106.01	White	\$4.51	\$3.67	400 \$3.12
54.106.02	Chrome	\$3.25	\$2.64	400 \$2.25
54.106.03	Antique Brass	\$3.47	\$2.82	400 \$2.40
54.106.07	Oil Rub Br.	\$4.41	\$3.59	400 \$3.05

SKU	Finish	Price per Each		
		Each	Case Qty	Case
#8, 5/8" Overlay		Each	100-Ct	Case
54.108.03	Antique Brass	\$3.47	\$2.82	400 \$2.40



Double Action Screen Hinge, Polished Brass, For Doors 3/4" Thick

This hinge allows a door to swing both ways. Comes in a polished brass finish. Screws not included.

SKU	Size	Price per Each		
		Each	Case Qty	Case
54.4001.06	1 3/4" H x 2" W	\$1.34	100	\$1.20

Recommended Screws: [0.FPC05012PB...](#) or [0.FPC05058PB...](#)

Butt Hinge, Tight Pin

Open Width: 1.5" x 1.5"
These cabinet butt hinges have a tight (permanent) pin.

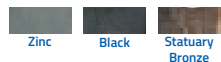

SKU	Finish	Price per Each		
		Each	Case Qty	Case
54.03201.04	Zinc	\$0.39	100	\$0.29
54.03201.08	Black	\$0.45	100	\$0.35
54.03201.05	Statuary Bronze	\$0.39	100	\$0.29
54.03201.06	Polished Brass	\$0.39	100	\$0.29

Recommended Screws: (4) [0.FPC05...](#)



3/4" Wrap Around Hinge, Polished Brass

The wrap around hinge offers great strength and stability for your kitchen cabinets. Polished Brass finish. Screws not included.

SKU	Size	Price per Each		
		Each	Case Qty	Case
54.20.06	1 1/2" x 3/4" (Tight Pin)	\$1.51	100	\$1.24

Recommended Screws: [0.FPC05012PB...](#)

Hammered, Exposed Flush Hinge, Black

The exposed 'H' hinges offer a modern look for your cabinets. Each hinge comes with a hammered black finish and 2 screw holes per leaf. Screws are not included.



SKU	Size	Hinge Style	Each
54.37.08	3 1/2" H x 1 1/2" W	Colonial 'H'	\$0.63
54.39.08	3" H x 1 3/4" W	Contemporary 'H'	\$1.00

Recommended Screws: [0.PPC06058B...](#)

Door Parts & Accessories



Hinge Hole Repair Kit

Save time and money by fixing a drilling mistake instead of replacing the whole door!

Each kit includes two 35mm plugs, four 8mm plugs, and one cotton swab for applying glue.

SKU	Description	Price per Each	
		Per Kit	Per 10
60.358A	Alder/Paint Grade Repair Kit	\$5.39	\$4.39
60.358H	Hickory Repair Kit	\$5.39	\$4.39
60.358O	Oak Repair Kit	\$5.39	\$4.39
60.358C	Cherry Repair Kit	\$5.39	\$4.39
60.358M	Maple Repair Kit	\$5.39	\$4.39
Individual Plugs			
60.35A	Alder 35mm Single Plug	\$1.75	\$1.29
60.35H	Hickory 35mm Single Plug	\$1.75	\$1.29
60.35O	Oak 35mm Single Plug	\$1.75	\$1.29
60.35C	Cherry 35mm Single Plug	\$1.75	\$1.29
60.35M	Maple 35mm Single Plug	\$1.75	\$1.29



Cabinet Door Pad, Self-Adhesive

SKU	Color	100	1,000	5,000
54.91.07	Brown Felt	\$0.03	\$0.0175	\$0.015
54.91.01	White Felt	\$0.03	\$0.0175	\$0.015
54.94.12	Almond Foam	\$0.03	\$0.019	\$0.017

Polyurethane Cabinet Door Bumper, Self-Adhesive



SKU	Type	Dia.	Height	Price Per Each					
				Each	Sheet Qty	Box Qty	Sheet	Box	
54.95.08	Black Flat	0.500"	0.125"	\$0.057	200 pcs	5000 pcs	\$0.0472	\$0.0404	
54.95.18	Gray Flat	0.500"	0.125"	\$0.056	200 pcs	5000 pcs	\$0.0472	\$0.0404	
54.92.00	Soft Round	0.375"	0.150"	\$0.0618	288 pcs	7200 pcs	\$0.0516	\$0.0442	
54.95.00	Soft Flat	0.500"	0.140"	\$0.0488	200 pcs	5000 pcs	\$0.0408	\$0.0349	
54.93.00	Soft Pyramid	0.500"	0.150"	\$0.0565	200 pcs	5000 pcs	\$0.0472	\$0.0404	
54.97.00	Round Pyramid	0.500"	0.20"	\$0.0565	200 pcs	5000 pcs	\$0.0472	\$0.0404	



Cabinet Door Magnetic Catch

This single magnetic catch for cabinet doors comes in three colors, and includes the necessary screws and plates. The pull force is 2.5 to 3.0 kgs.

SKU	Finish	Price Per Each		
		Each	Case Qty	Case
58.20.01	White	\$0.51	100	\$0.44
58.20.07	Brown	\$0.51	100	\$0.44
58.20.08	Black	\$0.51	100	\$0.44



Heavy Duty Magnetic Catch and Strike Plate, Aluminum

Screws included.

SKU	Finish	Price Per Each		
		Each	Case Qty	Case
EP.592	Aluminum	\$1.95	100	\$1.74
EP.592-ORB	Oil Rubbed Bronze	\$2.68	100	\$2.40



Magnetic Touch Latch, Black

Strike plate and screws not included with Double latches.

SKU	Latches	Price Per Each		
		Each	Case Qty	Case
58.24.08	Single	\$0.64	100	\$0.55
58.22.08*	Double	\$1.35	100	\$1.05

Recommended Screws: [0.FPC05058B17...](#)

*Recommended Strike Plates (Two Needed for Double): [58.7083.05...](#)



Strike Plate, 22mm x 26mm

SKU	Finish	Price Per Each		
		Each	Case Qty	Case
58.7083.04	Zinc	\$0.22	100	\$0.11
58.7083.05	Statuary Bronze	\$0.19	100	\$0.11

Recommended Screws: [0.FPC05012Z...](#) for Zinc, and [0.FPC05058B17...](#) for Statuary Bronze



Bull Dog Catch Set for Cabinet Doors, Bronze

SKU	Finish	Price Per Each		
		Each	Case Qty	Case
58.655	Bronze	\$0.49	100	\$0.42

Recommended Screws: [0.PPC06...](#) or [0.TPC06...](#)



Double Roller Catch for Cabinet Doors

SKU	Finish	Price Per Each		
		Each	Case Qty	Case
58.M038.05	Antique Copper	\$0.49	100	\$0.41

Recommended Screws: [0.PPC06012AB...](#)

Piano Hinges



72" Slotted Piano Hinge

These piano hinges are nice, flexible and can be used in pianos, bi-folding doors, and more! Available in 2 colors.

SKU	Width	Price per Each	
		Each	20-ct
Brass Finish			
H.1540A53C07200	1 1/2"	\$8.39	\$7.89
Chrome Finish			
H.1540A52C07200	1 1/2"	\$10.74	\$9.98

Screws: [0.PPC06058B...](#)

Folding Table Hinge



1 3/16" x 2 3/4" Folding Table Hinge

SKU	Type	Each
54.FT.06B	Brushed Solid Brass	\$4.28

Recommended Screws: [0.FPC08058PB...](#)

Entertainment Center Hinges



270° Entertainment Center Hinge

Perfect for entertainment centers! These 270° hinges allow the doors to swing to the side of the cabinet.

3/4" Door, 5/8" Overlay

SKU	Finish	Price per Each	
		Each	100-ct
54.9975.02	Nickel	\$1.74	\$1.36
54.9975.08	Black	\$1.76	\$1.36

Recommended Screws: [0.FPC06058...](#)

Institutional Hinge



Heavy Duty Institutional Hinge

- 5 Knuckle, 32mm Overlay
- | | | |
|--------------|---------------|--------|
| 54.72022.02D | Dull Chrome | \$3.33 |
| 54.72022.02B | Brush. Chrome | \$3.88 |
| 54.72022.08M | Matte Black | \$3.21 |

Recommended Screws: [0.FPC08034Z...](#)

Column Fold-Down Hinge



Column Fold-Down Hinge for Keyboard Trays & Pocket Doors

- Keeps the Door Closed at 90°
- Zinc

SKU: [H.1019879](#) Price: Zinc \$10.68

Recommended Screws: (Five) [0.FPC06058Z...](#)

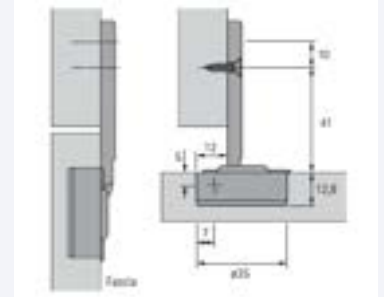

Concealed Hinges



90° Opening

Surface Mounted Concealed Hinge

SKU	Finish	Price per Each	
		Each	200-ct
54.2420	Nickel Plated Steel	\$1.19	\$0.99

Recommended Screws: [0.PPC06012Z...](#)

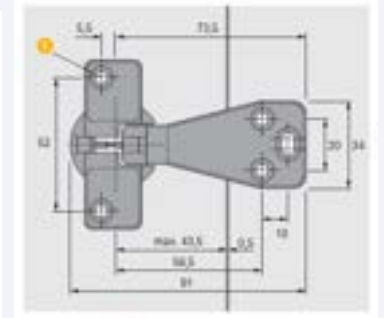

Concealed Hinge w/ 3-Way Adjustment Function

- Hinge Features:
- HES hinge design allows vertical, horizontal, and depth adjustment after the hinge is installed
 - Two piece assembly for easy installation and adjustment
 - Supplied with stainless steel flathead screws and template
 - Designed for interior installation
 - (Optional) Mounting Brackets sold separately



Recommended Door Specifications:
Max. Door Weight: 66 lbs. with two hinges

88 lbs. with

three hinges

Min. Door Thickness: 1 1/8"
Max. Door Dimensions (H x W): 94 1/2" x 35 1/16"

SKU	Color	Each
SA.HES3D-120BL	Black	\$60.00
SA.HES3D-120DN	Dull Nickel	\$60.00
SA.HES3D-120DC	Dull Chrome	\$60.00



Vix-Bit Self-Centering Drill



Vix-Bit



Replacement H.S. Drill

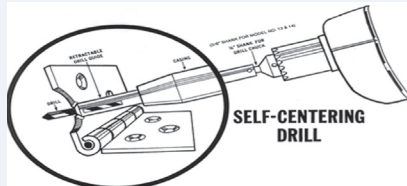

SELF-CENTERING DRILL

10.03	5/4"	Fits #2 & #3 Screws	\$13.55
10.03B	5/4"	Replacement H.S. Drill	\$2.88
10.05	7/4"	Fits #5 & #6 Screws	\$12.01
10.05B	7/4"	Replacement H.S. Drill	\$2.94
10.09	9/4"	Fits #8 & #10 Screws	\$11.24
10.09B	9/4"	Replacement H.S. Drill	\$3.03

1 1/2" x 1 7/8" Torque Hinge, 180° Opening



- 304 Stainless Steel
- Holds Lid In Any Position or Angle
- Innovative Torsion Mechanism
- Lid Depth (In.) x .0127 x Lid Weight (Lb.) x 3.97 = Min. Quantity of Hinges Needed (Max of 4 Recommended)
- Recommended Screw: [0.PPC08...](#)

SKU	Description	Box Qty	Price per Each	
			Each	Box
54.24111.55	Stainless Steel Finish	80	\$9.56	\$8.25
54.24111.55-BN	Black Nickel Finish	80	\$11.68	\$9.99

Mounting Brackets for SA.HES3D-E190** to Steel Doors

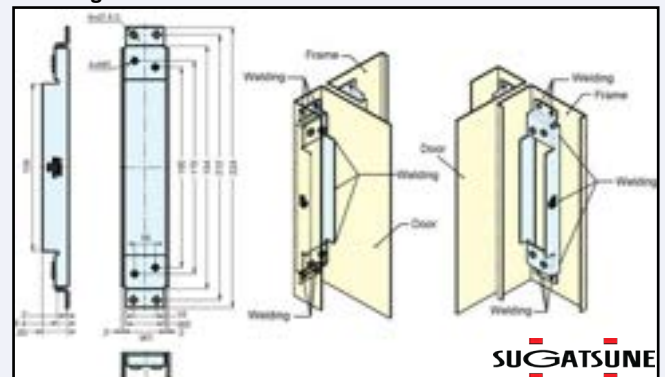

SUGATSUNE

SA.HES3D-E190BKT-D	\$8.80
SA.HES3D-E190BKT-F	\$8.80



The SOSS® cabinet-style Invisible Hinges are perfect for applications where flush fit, compact size, and smooth operation are essential. SOSS® Invisible Hinges are single-action hinges, open a full 180°, and can be used in either wood or metal applications.



Hinge #100, 1/2" Minimum Material Thickness

SKU	Size	Finish	Price per Pair
SH.100CUS4	1" x 3/8"	Satin Brass	\$18.72
SH.100CUS26D	1" x 3/8"	Satin Chrome	\$18.72



Hinge #101, 1/2" Minimum Material Thickness

SKU	Size	Finish	Price per Pair
SH.101CUS4	1 1/16" x 3/8"	Satin Brass	\$24.96
SH.101CUS26D	1 1/16" x 3/8"	Satin Chrome	\$24.96



Hinge #103, 3/4" Minimum Material Thickness

SKU	Size	Finish	Price per Pair
SH.103CUS4	1 1/2" x 1/2"	Satin Brass	\$22.16
SH.103CUS26D	1 1/2" x 1/2"	Satin Chrome	\$22.16



Hinge #203, 3/4" Minimum Material Thickness

SKU	Size	Finish	Price per Pair
SH.203CUS4	1 3/4" x 1/2"	Satin Brass	\$27.60
SH.203CUS26D	1 3/4" x 1/2"	Satin Chrome	\$27.60



Hinge #204, 3/4" Minimum Material Thickness

SKU	Size	Finish	Price per Pair
SH.204CUS4	2 3/8" x 1/2"	Satin Brass	\$28.43
SH.204CUS26D	2 3/8" x 1/2"	Satin Chrome	\$28.43



Hinge #208, 1" Minimum Material Thickness

SKU	Size	Finish	Price per Each
SH.208US4	2 3/4" x 5/8"	Satin Brass	\$17.53
SH.208US26D	2 3/4" x 5/8"	Satin Chrome	\$17.53



Hinge #212, 1 1/8" Minimum Material Thickness

SKU	Size	Finish	Price per Each
SH.212US4	3 3/4" x 3/4"	Satin Brass	\$32.49
SH.212US26D	3 3/4" x 3/4"	Satin Chrome	\$32.49



Hinge #216, 1 3/8" Minimum Material Thickness

SKU	Size	Finish	Price per Each
SH.216US4	4 5/8" x 1"	Satin Brass	\$51.35
SH.216US26D	4 5/8" x 1"	Satin Chrome	\$51.35

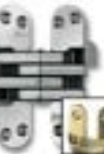

Hinge #218, 1 3/4" Minimum Material Thickness

SKU	Size	Finish	Price per Each
SH.218US4	4 5/8" x 1 1/8"	Satin Brass	\$54.27
SH.218US26D	4 5/8" x 1 1/8"	Satin Chrome	\$54.27



Hinge #220, 2" Minimum Material Thickness

SKU	Size	Finish	Price per Each
SH.220US4	5 1/2" x 1 3/8"	Satin Brass	\$86.48
SH.220US26D	5 1/2" x 1 3/8"	Satin Chrome	\$86.48

SOSS Router Templates



SH.101IT	#101	\$35.93
SH.103IT	#103	\$35.93
SH.203-IT	#203	\$25.05
SH.204IT	#204	\$35.93
SH.208IT	#208	\$35.93
SH.212IT	#212	\$35.93
SH.216IT	#216	\$35.93
SH.218IT	#218	\$35.93
SH.220IT	#220	\$35.93
SH.RGB100	Bushing & Lock	\$31.70

Screws Included



Invisible Spring Closer Hinge

Call for information about our Invisible Hinge additional finishes, Spring Closer Hinges, and Fire Rated Invisible Hinges.

Invisible Hinge Additional Finishes

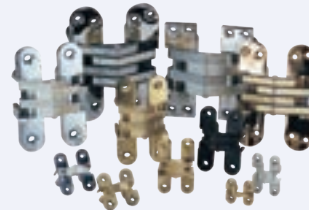

Fire Rated Invisible Hinge

SOSS Invisible Barrel Hinges



Size Comparison

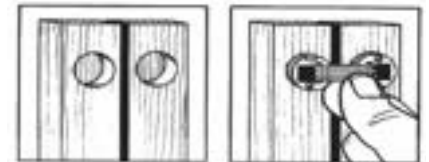

SKU	Min. Wood Thickness	Barrel Dia.	Each
SH.BH085	7/16" Min. Thickness	8mm	\$2.35
SH.BH104	1/2" Min. Thickness	10mm	\$2.35
SH.BH124	3/8" Min. Thickness	12mm	\$2.35
SH.BH144	3/4" Min. Thickness	14mm	\$2.84
SH.BH164	7/8" Min. Thickness	16mm	\$3.58
SH.BH184	1 1/8" Min. Thickness	18mm	\$4.64
SH.BH244	1 1/4" Min. Thickness	24mm	\$8.55





Hettich Two-Piece Clip-On Intermat Hinge

SKU	Overlay	Type	Style	Price per Each		
				Each	Case Qty	Case
H.1029521	Full	110°	Press-In	\$1.60	200	\$1.45
H.1073711	Full	110°	Screw-On	\$1.60	200	\$1.45
H.9046806	Half	110°	Screw-On	\$6.84	200	\$5.71
H.1030921	Half	110°	Press-In	\$1.30	200	\$1.10
H.9046807	Inset	110°	Screw-On	\$4.08	200	\$3.41
H.1030928	Inset	110°	Press-In	\$2.05	200	\$1.98
H.1058549	Full	125°	Press-In	\$2.05	200	\$1.51
H.9099621	Full	165°	Press-In	\$5.41	200	\$4.51
H.9099781	Half	165°	Press-In	\$11.37	100	\$7.89

Recommended Screws: [0.FPC06058Z...](#)



Replacement Screw for Hettich Hinge

SKU	Each
H.1037931	\$0.05



Replacement Dowel for Hettich Hinge

SKU	Each
H.1083885	\$0.05



Hettich Sensys Face Frame Overlay Mounting Plate

Compatible with Hettich Sensys and Intermat full overlay hinges only.

SKU	Type	Price per Each		
		Each	Case Qty	Case
H.9090882	3/4" Overlay w/ Cam Adj.	\$1.45	200	\$1.26
H.9090884	1/2" Overlay w/ Cam Adj.	\$1.15	200	\$0.88
H.9084930	3/4" Overlay	\$0.95	200	\$0.74
H.9084931	1/2" Overlay	\$1.15	200	\$0.96

Recommended Screws: [0.FPC08058Z...](#) (two per plate)

Hettich Sensys 165° Soft-Close Hinge

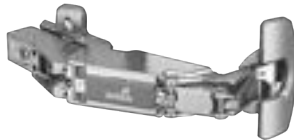

SKU	Overlay	Style	Price per Each		
			Each	Case Qty	Case
H.9099561	Full	Press-In	\$8.37	200	\$5.87
H.9099571	Half	Press-In	\$8.60	200	\$6.03

Hettich Intermat 2-Piece Cam Adjustable Mounting Plate, Frameless

Wing mount. Compatible with Hettich Intermat and Ecomat hinges.



SKU	Height	Price per Each		
		Each	Case Qty	Case
H.1071745	0mm	\$0.92	400	\$0.88
H.1071746	1.5mm	\$0.89	400	\$0.69
H.1071747	3mm	\$0.91	400	\$0.70

Hettich Standard Mounting Plate

Wing mount. Compatible with Hettich Intermat and Sensys hinges.



Includes 5mm Euro Screws

SKU	Height	Price per Each		
		Each	Case Qty	Case
H.9071625	0mm	\$0.45	200	\$0.44
H.9071626	1.5mm	\$0.48	200	\$0.45
H.9071627	3mm	\$0.53	200	\$0.46
H.9071628	5mm	\$0.72	200	\$0.48



No Screws Included

SKU	Height	Price per Each		
		Each	Case Qty	Case
H.9071575	0mm	\$0.45	200	\$0.39
H.9071576	1.5mm	\$0.41	200	\$0.30
H.9071577	3mm	\$0.45	200	\$0.33
H.9071578	5mm	\$0.60	200	\$0.44

Recommended Screws: [0.FPC08...](#) (two per plate)

Hettich Sensys/Intermat Cam Adjustable Mounting Plate, Frameless W/Premounted Wood Screws



Frameless (5mm Euro Screws included)

SKU	Height	Price per Each		
		Each	Case Qty	Case
H.9071670	0mm	\$0.84	200	\$0.62
H.9071672	1.5mm	\$0.91	200	\$0.67

Hettich Sensys/Intermat Face Frame Inset Mounting Plate

Compatible with Hettich Intermat and Ecomat half overlay hinges only. 4.5mm cup hole distance.



SKU	Type	Price per Each		
		Each	Case Qty	Case
H.1135793	Inset w/ Cam Adj.	\$5.87	200	\$5.39

Recommended Screws: [0.FPC08058Z...](#) (two per plate)



BLUMOTION Soft-Close Damper Add-On Kit, Works With Any Cabinet Door

Polybag kit includes damper, spacer and screws.

SKU	Each	Case Qty	Price per Each	
			Case	10-Case
B.971A9700.22	\$4.82	125	\$4.02	\$3.44

Blum Platamate Boring Template Kit

This template kit provides quick and accurate attachment of all Blum CLIP face frame mounting plates. Works on face frame thicknesses between 7/8" and 1". Includes Platamate template, 2.5mm pilot bit with extension, and 5mm stop collar.



SKU	Each
B.65.5030.01	\$132.02

Cabinet Hinge Drill Template Kit for Hidden Hinges

Conveniently install your concealed hinges with this easy-to-use kit! Includes 35mm boring bit and template for marking hinge holes. **Note: This kit cannot be used in face frame applications.**



SKU	Each
HH.PBH3100	\$16.84

Pride Industrial Economy 110° Two-Piece, Soft-Close Hinge



SKU	Overlay	Style	Price per Each		
			Each	Case Qty	Case
PI.3311-8D-SC	Full	Press-In	\$2.61	200	\$2.18
PI.3311-SC	Full	Screw-On	\$2.58	200	\$2.15
PI.3322-8D-SC	Half	Press-In	\$2.61	200	\$2.18
PI.3322-SC	Half	Screw-On	\$2.58	200	\$2.15
PI.3333-8D-SC	Inset	Press-In	\$2.61	200	\$2.18
PI.3333-SC	Inset	Screw-On	\$2.58	200	\$2.15



Pride Industrial Economy Frameless Mounting Plate

Compatible with Pride Industrial Economy 110° Soft-Close hinges.

SKU	Height	Style	Price per Each		
			Each	Case Qty	Case
PI.3300	0mm	Screw-On	\$0.31	200	\$0.26
PI.96T00TQ	0mm	Euro Screws	\$0.69	200	\$0.58
PI.96T20TQ	2mm	Euro Screws	\$0.70	200	\$0.58

Recommended Screws: [0.TPC08...](#) (to attach to face frame) and [0.FPC06...](#) (to attach screw-on hinge to door)

Pride Industrial Economy Face Frame, Screw-On Mounting Plate

Compatible with Pride Industrial Economy 110° Soft-Close hinges.



SKU	Height	Price per Each		
		Each	Case Qty	Case
PI.3300-SC	0mm	\$0.49	200	\$0.41
PI.3303-SC	3mm	\$0.49	200	\$0.41

Recommended Screws: [0.TPC08...](#) (to attach to face frame) and [0.FPC06...](#) (to attach screw-on hinge to door)



Blum 110° CLIP top BLUMOTION Soft-Close Hinge

SKU	Overlay	Design Type	Style	Price per Each			
				Each	Case Qty	Case	10-Case
B.71B3550	Full	Straight Arm	Screw-On	\$4.73	250	\$3.95	\$3.39
B.71B3580	Full	Straight Arm	Press-In	\$5.00	250	\$4.18	\$3.58
B.71B3590	Full	Straight Arm	INSERTA	\$5.83	250	\$4.87	\$4.17
B.71B3650	Partial	Half-Cranked	Screw-On	\$5.46	250	\$4.56	\$3.90
B.71B3680	Partial	Half-Cranked	Press-In	\$5.23	250	\$4.36	\$3.74
B.71B3690	Partial	Half-Cranked	INSERTA	\$6.11	250	\$5.10	\$4.37
B.71B3750	Inset	Full-Cranked	Screw-On	\$5.14	250	\$4.29	\$3.67

Blum 110° CLIP top Self-Close Hinge

SKU	Overlay	Design Type	Style	Price per Each			
				Each	Case Qty	Case	10-Case
B.71T3550	Full	Straight Arm	Screw-On	\$2.24	250	\$1.87	\$1.60
B.71T3580	Full	Straight Arm	Press-In	\$2.11	250	\$1.76	\$1.51
B.71T3590	Full	Straight Arm	INSERTA	\$3.27	250	\$2.73	\$2.33
B.71T3650	Partial	Half-Cranked	Screw-On	\$2.70	250	\$2.25	\$1.93
B.71T3680	Partial	Half-Cranked	Press-In	\$2.85	250	\$2.38	\$2.03
B.71T3690	Partial	Half-Cranked	INSERTA	\$3.62	250	\$3.02	\$2.59
B.71T3750	Inset	Full-Cranked	Screw-On	\$2.76	250	\$2.30	\$1.97
B.71T3780	Inset	Full-Cranked	Press-In	\$2.88	250	\$2.41	\$2.06

Recommended Screws: [0.FPC06...](#)



Blum 120° CLIP top Self-Close Hinge

SKU	Overlay	Design Type	Style	Price per Each			
				Each	Case Qty	Case	10-Case
B.71T5550	Full	Straight Arm	Screw-On	\$2.28	250	\$1.90	\$1.63
B.71T5580	Full	Straight Arm	Press-In	\$2.11	250	\$1.76	\$1.51
B.71T5650	Partial	Half-Cranked	Screw-On	\$2.73	250	\$2.28	\$1.95
B.71T5680	Partial	Half-Cranked	Press-In	\$2.87	250	\$2.39	\$2.05

Blum 120° CLIP top Self-Close Hinge (for larger overlays)

SKU	Overlay	Design Type	Style	Price per Each			
				Each	Case Qty	Case	10-Case
B.73T5550	Full	Straight Arm	Screw-On	\$2.28	250	\$1.90	\$1.63
B.73T5580	Full	Straight Arm	Press-In	\$2.11	250	\$1.76	\$1.51

Recommended Screws: [0.FPC06...](#)

Blum 95° CLIP top Inset Blind Corner Hinge

This hinge is designed for use in blind corner cabinets and features three-dimensional adjustment with self-closing operation. Opens up to 125°.

SKU	Style	Each	Case Qty	Price per Each	
				Case	10-Case
B.79T9550	Screw-On	\$5.21	50	\$4.35	\$3.72

Recommended Screws: [0.FPC06...](#)

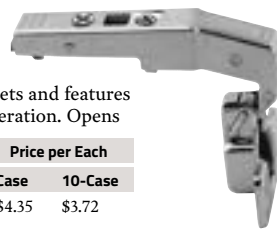

Blum Pozi Screwdriver



B.SR-DREH.K-SCHL \$9.86

Optional 86° Angle Restriction Clip for CLIP top 110° Hinges

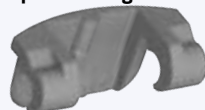

Compatible with all 110° CLIP top and CLIP top BLUMOTION hinges.

SKU	Each	Case Qty	Price per Each	
			Case	10-Case
B.70T3553	\$0.82	250	\$0.68	\$0.58



Blum 155° CLIP top, Zero Protrusion, Self-Close Hinge

Designed for cabinets with interior roll-outs - zero door protrusion at a 90° opening.

SKU	Overlay	Design Type	Style	Price per Each			
				Each	Case Qty	Case	10-Case
B.71T7500N	Full	Straight Arm	Screw-On	\$5.54	25	\$4.43	\$3.89
B.71T7590	Full	Straight Arm	Inserta	\$8.25	25	\$6.89	\$5.90
B.70T7503N		Angle Restriction Clip 110°		\$0.77	500	\$0.61	\$0.55

BLUMOTION Soft-Close

B.71B7550	Full	Straight Arm	Screw-On	\$9.43	125	\$7.87	\$6.74
-----------	------	--------------	----------	--------	-----	--------	--------

Recommended Screws: [0.FPC06...](#)



Blum 170° CLIP top Self-Close Hinge

SKU	Overlay	Design Type	Style	Price per Each			
				Each	Case Qty	Case	10-Case
B.71T6550	Full	Straight Arm	Screw-On	\$5.00	125	\$4.18	\$3.58
B.71T6580	Full	Straight Arm	Press-In	\$5.14	125	\$4.29	\$3.68
B.71T6650	Partial	Half-Cranked	Screw-On	\$6.97	125	\$5.82	\$4.99
B.71T6680	Partial	Half-Cranked	Press-In	\$7.11	125	\$5.94	\$5.09
B.70.6103		Angle Restriction Clip 130°		\$0.59	250	\$0.25	\$0.23
B.973A6000		BLUMOTION Soft-Close Mechanism		\$4.33	25	\$3.72	\$3.43

Recommended Screws: [0.FPC06...](#)



Blum Diagonal 45° CLIP top Self-Close Hinge

This 45° diagonal hinge has an 110° opening angle and is designed for attaching doors to 135° angled cabinets. Three-dimensional adjustment and self-closing operation.

SKU	Overlay	Design Type	Style	Price per Each			
				Each	Case Qty	Case	10-Case
B.79T5550	Full	45° Diagonal	Screw-On	\$5.72	50	\$4.77	\$4.09
B.79T5580	Full	45° Diagonal	Press-In	\$5.85	50	\$4.88	\$4.18
B.79B3598	Full	45° Diagonal	INSERTA	\$8.81	50	\$7.36	\$6.30

Recommended Screws: [0.FPC06...](#)

Blum 90° CLIP top Bi-Fold, Self-Close Hinge

This hinge is designed for the inside corner of a 90° bi-fold cabinet door. Four-dimensional adjustment and self-closing operation.

SKU	Style	Each	Case Qty	Price per Each	
				Case	10-Case
B.79T8500.10	Screw-On	\$8.09	25	\$6.76	\$5.79
B.79T8530.10	Press-In	\$8.22	25	\$6.86	\$5.88

Recommended Screws: [0.FPC06...](#)



Optional Cover Caps for Blum CLIP top Hinges

Image	SKU	Design	Hinge Type	Price per Each			
				Each	Case Qty	Case	10-Case
	B.70.1503	Straight Arm	100°, 107°, 110°, 110°, 120°, 120°, thick door, bi-fold, diagonal 45°, blind corner	\$0.27	1,000	\$0.22	\$0.19
	B.70.1663	Cranked Arm	100°, 110°, 120°, 95° thick door	\$0.25	1,000	\$0.21	\$0.18
	B.80.6507	170°	170°	\$0.13	1,000	\$0.11	\$0.10

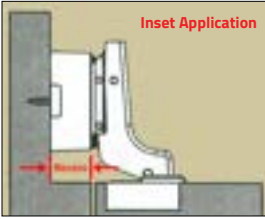
CLIP WING MOUNTING PLATE For Inset Doors On Face Frame Cabinets

Accommodates inset doors on face frame cabinet.
Screw-On Style
Nickel Finish

SKU	Plate Height	Recess*	Each	Case Qty	Price per Each	
					Case	10-Case
B.173H9100.04	6mm	1/4"	\$2.19	250	\$1.83	\$1.56
B.173H9130.06	9mm	3/8"	\$2.19	250	\$1.83	\$1.56
B.173H9100.08	13mm	1/2"	\$2.31	250	\$1.93	\$1.65
B.173H9130.10	16mm	5/8"	\$2.31	250	\$1.93	\$1.65
B.173H9100.12	19mm	3/4"	\$2.44	250	\$2.03	\$1.74
B.173H9130.14	22mm	7/8"	\$2.44	250	\$2.03	\$1.74
B.173H9100.16	25mm	1"	\$2.56	250	\$2.14	\$1.83
B.173H9130.18	29mm	1-1/8"	\$2.56	250	\$2.14	\$1.83

Recommended Screws: [0.FPC08***](#)

*When used with inset hinge

Blum CLIP One-Piece Wing Mounting Plate for Frameless Cabinets

Compatible with all Blum CLIP top series hinges.

One-Piece, No Screws Included

SKU	Plate Height	Style	Material	Each	Case Qty	Price per Each	
						Case	10-Case
B.173L6100	0mm	Screw-On	Steel	\$0.36	500	\$0.30	\$0.26
B.173L6130	3mm	Screw-On	Steel	\$0.43	500	\$0.36	\$0.31

Recommended Screws: [0.FPC08...](#)

One-Piece with 5mm Euro System Screws

SKU	Plate Height	Style	Material	Each	Case Qty	Price per Each	
						Case	10-Case
B.173L8100	0mm	Pre-Mount	Steel	\$0.32	500	\$0.25	\$0.24
B.173L8130	3mm	Pre-Mount	Steel	\$0.52	500	\$0.43	\$0.37

Blum CLIP One-Piece Wing Mounting Plate, Cam Adjustable for Frameless Cabinets

Compatible with all Blum CLIP top series hinges.

For use with #8 wood screws

SKU	Plate Height	Style	Material	Each	Case Qty	Price per Each	
						Case	10-Case
B.173H7100	0mm	Screw-On	Steel	\$0.70	500	\$0.59	\$0.50
B.173H7130	3mm	Screw-On	Steel	\$0.84	500	\$0.70	\$0.60

Recommended Screws: [0.FPC08...](#)

For use with #8 wood screws or 13mm system screws

SKU	Plate Height	Style	Material	Each	Case Qty	Price per Each	
						Case	10-Case
B.173H9100	0mm	Screw-On	Steel	\$0.70	500	\$0.59	\$0.50
B.173H9130	3mm	Screw-On	Steel	\$0.84	500	\$0.70	\$0.60

Recommended Screws: [0.FPC08...](#) or [0.FPZE63013Z...](#)

Blum CLIP two-Piece Wing Mounting Plate for Frameless Cabinets

Compatible with all Blum CLIP top series hinges.

For use with #8 wood screws

SKU	Plate Height	Style	Material	Each	Case Qty	Price per Each	
						Case	10-Case
B.175H7100	0mm	Screw-On	Zinc Die-Cast	\$1.17	500	\$0.98	\$0.84
B.175H7130	3mm	Screw-On	Zinc Die-Cast	\$1.36	250	\$1.13	\$0.97
B.175H7190	9mm	Screw-On	Zinc Die-Cast	\$1.81	250	\$1.51	

Recommended Screws: [0.FPC08...](#)

For use with #8 wood screws or 13mm system screws

SKU	Plate Height	Style	Material	Each	Case Qty	Price per Each	
						Case	10-Case
B.175H9100	0mm	Screw-On	Zinc Die-Cast	\$1.16	500	\$0.97	\$0.83
B.175H9190.22	18mm	Screw-On	Zinc Die-Cast	\$2.62	250	\$2.19	\$1.87

Recommended Screws: [0.FPC08...](#) or [0.FPZE63013Z...](#)

Blum CLIP Inset Cam Adjustable Mounting Plate for Face Frame Cabinets, 9mm

This hinge is for use with partial overlay hinges.
Compatible with all Blum CLIP top series hinges.
Requires 3/4" recess.



SKU	Plate Height	Style	Material	Each	Case Qty	Price per Each	
						Case	10-Case
B.175H5030.21	9mm	Screw-On	Zinc Die-Cast	\$2.35	250	\$1.96	\$1.68

Recommended Screws: [0.TPC08...](#)

Blum CLIP Center Mounting Plate for Face Frame Cabinets, 9.5mm

Compatible with all Blum CLIP top series hinges.



SKU	Plate Height	Style	Material	Each	Case Qty	Price per Each	
						Case	10-Case
B.175L6030.21	3mm	Screw-On	Zinc Die-Cast	\$0.84	500	\$0.70	\$0.60

Recommended Screws: [0.FPC08...](#)

Blum CLIP Cam Adjustable, Center Mounting Plate for Face Frame Cabinets, 9.5mm

Compatible with all Blum CLIP top series hinges.



SKU	Plate Height	Style	Material	Each	Case Qty	Price per Each	
						Case	10-Case
B.175H6000	0mm	Screw-On	Steel, Zinc Die-Cast	\$1.13	250	\$0.95	\$0.81
B.175H6030	3mm	Screw-On	Steel	\$1.26	250	\$1.05	\$0.90
B.175H6040	4.5mm	Screw-On	Steel	\$1.38	250	\$1.15	\$0.98
B.175H6060	6mm	Screw-On	Steel	\$1.49	250	\$1.24	\$1.06

Recommended Screws: [0.FPC08...](#)

Blum CLIP Off-Center Mounting Plate for Face Frame Cabinets, 12.5mm

Compatible with all Blum CLIP top series hinges.

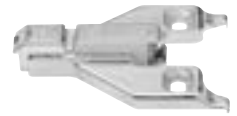

SKU	Plate Height	Style	Material	Each	Case Qty	Price per Each	
						Case	10-Case
B.175L6600.22	0mm	Screw-On	Zinc Die-Cast	\$0.79	500	\$0.66	\$0.56
B.175L6600.24	0mm w/ Flange*	Screw-On	Zinc Die-Cast	\$1.50	250	\$1.26	\$1.08
B.175L6630.22	3mm	Screw-On	Zinc Die-Cast	\$0.84	500	\$0.70	\$0.60
B.175L6660.22	6mm	Screw-On	Zinc Die-Cast	\$1.09	250	\$0.91	\$0.78

Recommended Screws: [0.FPC08...](#)

*Recommended for wide-angled hinges

Blum CLIP Cam Adjustable, Off-Center Mounting Plate for Face Frame Cabinets, 12.5mm

Compatible with all Blum CLIP Top series hinges.



SKU	Plate Height	Style	Material	Each	Case Qty	Price per Each	
						Case	10-Case
B.175H6600	0mm	Screw-On	Steel, Zinc Die-Cast	\$1.14	250	\$0.95	\$0.81

Recommended Screws: [0.FPC08...](#)

BLUMOTION Soft-Close Clip-On Mechanism for Blum CLIP top Hinges (Optional)

Add a soft-close feature to your existing hinges. For use only with Blum CLIP top hinges.

SKU	Design	Hinge Type	Case Qty	Price per Each		
				Each	Case	10-Case
B.973A0500.01	Full-Overlay	CLIP top 95°, 100°, 107°, 110°, 110° Plus, 120°, 120° Plus, thick door	50	\$2.68	\$2.25	\$1.93
B.973A0600	Half-Overlay	CLIP top 95°, 107°, 110°, 120°, clip 100°, 120° Plus	50	\$3.99	\$2.55	\$2.24
B.973A6000	Half-Overlay	CLIP top 170°	125	\$4.33	\$3.72	\$3.43



Blum COMPACT BLUMOTION Soft-Close Face Frame Hinge, One-Piece, 6-Way Adjustable

38N and 39C models available.

SKU	Overlay	Type	Style	Price per Each			
				Each	Case Qty	Case	10-Case
B.38N358B.05	5/16"	38N 105°	Press-In	\$3.54	250	\$2.95	\$3.54
B.38N358B.06	3/8"	38N 105°	Press-In	\$3.54	250	\$2.95	\$2.53
B.38N358B.07	7/16"	38N 105°	Press-In	\$3.58	250	\$2.96	\$2.53
B.38N358B.08	1/2"	38N 105°	Press-In	\$3.54	250	\$2.95	\$2.53
B.38N358B.10	3/8"	38N 105°	Press-In	\$3.54	250	\$2.95	\$2.50
B.38N358B.12	3/4"	38N 105°	Press-In	\$3.54	250	\$2.95	\$2.53
B.39C358B.16	1"	39C 110°	Press-In	\$3.62	300	\$3.02	\$2.59
B.39C358B.20	1 1/4"	39C 110°	Press-In	\$3.62	300	\$3.02	\$2.59
B.39C358B.21	1 5/16"	39C 110°	Press-In	\$3.62	300	\$3.02	\$2.59
B.39C358B.22	1 3/8"	39C 110°	Press-In	\$3.62	300	\$3.02	\$2.59
B.39C358B.24	1 1/2"	39C 110°	Press-In	\$3.62	300	\$3.02	\$2.59
B.38N355B.06	3/8"	38N 105°	Screw-On	\$3.46	250	\$2.89	\$2.47
B.38N355B.08	1/2"	38N 105°	Screw-On	\$3.46	250	\$2.89	\$2.47
B.38N355B.10	5/8"	38N 105°	Screw-On	\$3.46	250	\$2.89	\$2.47
B.38N355B.12	3/4"	38N 105°	Screw-On	\$3.46	250	\$2.89	\$2.47
B.39C355B.16	1"	39C 110°	Screw-On	\$3.55	300	\$2.96	\$2.53
B.39C355B.20	1 1/4"	39C 110°	Screw-On	\$3.55	300	\$2.96	\$2.96
B.39C355B.21	1 5/16"	39C 110°	Screw-On	\$3.55	300	\$2.69	\$2.53
B.39C355B.22	1 3/8"	39C 110°	Screw-On	\$3.55	300	\$2.96	\$2.53
B.39C355B.24	1 1/2"	39C 110°	Screw-On	\$3.55	300	\$2.96	\$2.53

Variable Overlay Face Mount Hinge

SKU	Overlay	Type	Style	Each	Case Qty	Case	10-Case
B.38B355BF22	1 3/8" or Greater	38B 107°	Screw-On	\$3.96	250	\$3.30	\$2.83

Recommended Screws: **0.TPC08...** to attach to face frame and **0.FPC06...** to attach screw-on hinges to door

Kreg Tool Concealed Hinge Jig for Drilling 35mm Holes

Features accurate hinge positioning with built in indexing tabs, repeatable results, and reliable drilling with bit guide and stop collar. A 1/16" bit is required to drill for hinge-mounting screws (not included). 35mm bit included.



KT.KHI-HINGE \$29.00



Blum COMPACT Standard Face Frame Hinge, One-Piece, 6-Way Adjustable

38N and 39C models available.

SKU	Overlay	Type	Style	Price per Each			
				Each	Case Qty	Case	10-Case
B.38N358C.06	3/8"	38N 105°	Press-In	\$1.85	250	\$1.54	\$1.32
B.38N358C.07	7/16"	38N 105°	Press-In	\$1.45	250	\$1.16	\$1.00
B.38N358C.08	1/2"	38N 105°	Press-In	\$1.46	250	\$1.22	\$1.05
B.38N358C.10	5/8"	38N 105°	Press-In	\$1.85	250	\$1.54	\$1.32
B.38N358C.12	3/4"	38N 105°	Press-In	\$1.85	250	\$1.54	\$1.32
B.39C358C.16	1"	39C 110°	Press-In	\$2.14	300	\$1.79	\$1.53
B.39C358C.19	1 3/16"	39C 110°	Press-In	\$1.64	300	\$1.31	\$1.15
B.39C358C.20	1 1/4"	39C 110°	Press-In	\$1.72	300	\$1.44	\$1.23
B.39C358C.21	1 5/16"	39C 110°	Press-In	\$1.64	300	\$1.31	\$1.15
B.39C358C.22	1 3/8"	39C 110°	Press-In	\$2.14	300	\$1.79	\$1.53
B.39C358C.24	1 1/2"	39C 110°	Press-In	\$2.14	300	\$1.79	\$1.53
B.39C358C.25	1 9/16"	39C 110°	Press-In	\$2.14	300	\$1.79	\$1.53
B.38N355C.06	3/8"	38N 105°	Screw-On	\$1.76	250	\$1.47	\$1.26
B.38N355C.08	1/2"	38N 105°	Screw-On	\$1.37	250	\$1.14	\$0.98
B.38N355C.10	5/8"	38N 105°	Screw-On	\$1.76	250	\$1.47	\$1.26
B.38N355C.12	3/4"	38N 105°	Screw-On	\$1.76	250	\$1.47	\$1.26
B.39C355C.16	1"	39C 110°	Screw-On	\$2.05	300	\$1.71	\$1.47
B.39C355C.20	1 1/4"	39C 110°	Screw-On	\$1.63	300	\$1.36	\$1.16
B.39C355C.21	1 5/16"	39C 110°	Screw-On	\$1.50	300	\$1.20	\$1.12
B.39C355C.22	1 3/8"	39C 110°	Screw-On	\$2.05	300	\$1.71	\$1.47

Recommended Screws: **0.TPC08...** to attach to face frame and **0.FPC06...** to attach screw-on hinges to door

Optional 86° Angle Restriction Clip for BLUMOTION Soft-Close Hinges



For use only with COMPACT BLUMOTION B.38N and B.39C hinges. Not to be used with standard Blum COMPACT Hinges. Must be installed before hinge installation.

SKU	Design Type	Price per Each			
		Each	Case Qty	Case	10-Case
B.38C315B3.1	86° Restriction Clip	\$0.15	250	\$0.12	\$0.10

Optional 1.5mm Hinge Cup Spacer for BLUMOTION Soft-Close Hinges



This 1.5mm hinge cup spacer is for retrofitting existing doors with a cup depth less than 13mm. For use only with COMPACT BLUMOTION B.38N and B.39C hinges.

SKU	Design Type	Price per Each			
		Each	Case Qty	Case	10-Case
B.38C355B9	1.5mm Hinge Spacer	\$2.09	250	\$1.75	\$1.50

Optional Cover Caps for Blum Compact Hinges

Image	SKU	Hinge Type	Design	Price per Each			
				Each	Case Qty	Case	10-Case
	B.38N3508BBP	All 38N Hinges	Engraved Blum Logo	\$0.14	1,000	\$0.12	\$0.10
	B.38N3508B	All 38N Hinges	Blank Cap	\$0.18	1,000	\$0.15	\$0.13
	B.38C3508	All 39C Hinges	Blank Cap	\$0.13	1,000	\$0.11	\$0.10

35mm Concealed Hinge Jig Bit

Works with all 35mm concealed hinges. The spurs create clean hole edges without tearout. The shoulder ensures accurate stop-collar positioning (stop collar sold separately with Concealed Hinge Jig).



KT.KHI-BIT \$19.99



COMPACT 33 110° Variable Overlay Face Frame Hinge

A COMPACT 33 mounting plate is required for each hinge

SKU	Style	Price per Each			
		Each	Case Qty	Case	10-Case
B.33.3600	Screw-On	\$3.86	250	\$3.22	\$2.76
B.33.3630	Press-In	\$3.97	250	\$3.32	\$2.84

COMPACT 33 Mounting Plate

Required when purchasing Blum COMPACT 33 110° hinges

SKU	Overlay	Price per Each			
		Each	Case Qty	Case	10-Case
B.130.1100.24	1/4"	\$2.42	250	\$2.02	\$1.73
B.130.1100.23	1/2"	\$2.07	250	\$1.73	\$1.48
B.130.1100.26	5/8"	\$2.18	250	\$1.82	\$1.56
B.130.1100.22	3/4"	\$2.07	250	\$1.73	\$1.48
B.130.1110.02	1"	\$2.07	250	\$1.73	\$1.48
B.130.1120.02	1 1/8"	\$2.03	250	\$1.69	\$1.45
B.130.1130.02	1 1/4"	\$2.07	250	\$1.73	\$1.48
B.130.1140.02	1 3/8"	\$2.12	250	\$1.77	\$1.52
B.130.1150.02	1 1/2"	\$2.17	250	\$1.81	\$1.55
B.130.1160	1 5/8"	\$2.18	250	\$1.82	\$1.56

SKU	Overlay	Each	Case Qty	Case	10-Case
B.133.0240	1 3/8" or Greater	\$0.57	500	\$0.45	\$0.41

Recommended Screws: **0.FPC06...**



Face Mount



Ferrari IC Economy E90 Clip-On Hinge

This clip-on hinge is fully adjustable and features a safe, easy release system. A mounting plate is required.

Vertical Adj. -2mm / +2mm
 Overlay Adj. -0.5mm / +4mm
 Frontal Adj. 0mm / +3mm

Price per Each

SKU	Overlay	Style	Each	Case Qty	Case
FR.E90300A	170° Full	Screw-On	\$3.04	100	\$2.54
FR.E90300B	170° Half	Screw-On	\$2.80	100	\$2.21

Recommended Screws: For Screw-On hinges, use two **0.FPC06...** screws



Ferrari IC Economy Mounting Plate

Required when purchasing Ferrari IC Economy Clip-On Hinges

Price per Each

SKU	Overlay	Type	Each	Case Qty	Case
FR.EB0780MG30	1/2"	Face Frame	\$0.34	400	\$0.29
FR.EB1002MG20*	2mm	Frameless	\$0.24	400	\$0.20
FR.EB2150MG00	0mm	Frameless	\$0.42	400	\$0.35
FR.EB1410MG20	2mm	Frameless	\$0.21	400	\$0.17

*Premounted 5mm euroscrews

Recommended Screws: **0.FPC08...** (two per plate)



Ferrari Economy Inside Corner 90° Hinge

This hinge is designed for the inside corner of a 90° bi-fold door. Mounting plate **FR.EB1410MG00** is required.

Price per Each

SKU	Style	Each	Case Qty	Case
FR.E90731GG	Press-In	\$2.22	200	\$1.85

Hinge-A-Series Pie Cut Corner Hinge, Nickel Plated



- 78° Max. Opening Angle
- Requires Two 35mm Cup Holes

HA.34390710 Nickel Plated \$7.99

Recommended Screws: **0.FPC08...**

Ferrari ES51 110° 6-Way Adjustable, Compacta One-Piece Face Frame Hinge



Small hinge suitable for frame cabinets. Standard hole pattern with 4mm tab distance. No mounting plate needed.

Price per Each

SKU	Overlay	Style	Each	Case Qty	Case
FR.E51079BGG	1/2"	Screw-On	\$0.82	200	\$0.69

Recommended Screws: **0.FPC06058Z17...**

Ferrari ET88 105° 6-Way Adjustable, Compacta One-Piece Face Frame Hinge

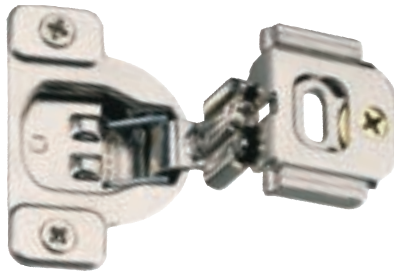

Vertical Adj. -3mm / +3mm
 Overlay Adj. 0mm / +3mm
 Frontal Adj. -2mm / +2mm

Price per Each

SKU	Overlay	Style	Each	Case Qty	Case
FR.ET887141GG	1 1/4"	Press-In	\$1.16	350	\$0.97
FR.ET887143GG	1 3/8"	Press-In	\$1.10	350	\$0.87

Recommended Screws: **0.FPC06058Z17...** (two per hinge) and **0.TPC08058Z17...** (one per hinge)

Titus 105° 2-Way Adjustable, One-Piece Face Frame Hinge



This 2-way adjustable hinge features a shallow 10mm cup depth and its vertical adjustment range is between -3.5mm and +3.5mm.

Price per Each

SKU	Overlay	Style	Each	Case Qty	Case
TI.970.9812.050	1/2"	Screw-On	\$0.60	500	
TI.970.9816.050	1/2"	Press-In	\$0.89	500	\$0.47

Recommended Screws: **0.FPC06058Z17...** (two per hinge) and **0.TPC08058Z17...** (one per hinge)

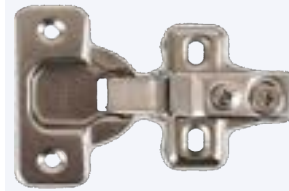

Ferrari Economy ES52 110° Soft-Close, 6-Way Adjustable, Compacta One-Piece Face Frame Hinge

Soft-closing hinge with cam adjustment. Standard hole pattern with 4mm tab distance. No mounting plate needed.

Price per Each

SKU	Overlay	Style	Each	Case Qty	Case
FR.E52079BGG	1/2"	Screw-On	\$1.97	200	\$1.65
FR.E52079CGG	5/8"	Screw-On	\$1.83	200	\$1.53
FR.E52081BGG	1/2"	Press-In	\$2.00	200	\$1.67
FR.E52081CGG	5/8"	Press-In	\$1.79	200	\$1.49

Recommended Screws: **0.FPC08058...**

Economy Compact Soft-Close Hinges

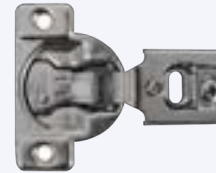

Price per Each

SKU	Overlay	Style	Each	Case Qty	Case
PI.H294-D-SC	1/2"	Press-in	\$2.11	200	\$1.76
PI.H294-SC	1/2"	Screw-on	\$2.08	200	\$1.74
PI.H295-D-SC	3/4"	Press-in	\$2.11	200	\$1.76
PI.H295-SC	3/4"	Screw-on	\$2.08	200	\$1.74
PI.H297-D-SC	1 1/4"	Press-in	\$2.24	200	\$1.87
PI.H297-SC	1 1/4"	Screw-on	\$2.21	200	\$1.85

Use screw **0.TPC08...** to attach to face frame

Use Screw **0.FPC06...** to attach screw-on hinges to door



Hettich Optimat 3E 105° 6-Way Adjustable, One-Piece Face Frame Hinge

Hinge and silent system mechanism sold separately.

Price per Each

SKU	Overlay	Style	Each	Case Qty	Case
H.9096446	1/2"	Press-In	\$3.89	300	\$3.24
H.9096454	1 1/4"	Press-In	\$1.11	300	\$0.74
H.9096458	1 3/8"	Press-In	\$1.11	300	\$0.74
H.9096459	Silent System add-on		\$2.81	300	\$2.07

Recommended Screws: **0.PPC08...**



SKU	Overlay	Style	Each
TI.970.9812.050	1/2"	Screw-On	\$0.60
TI.970.9816.050	1/2"	Press-In	\$0.89
TI.970.9819.050	1-1/4"	Screw-On	\$0.91
TI.970.9819.050	1-1/4"	Press-In	\$0.91

Use screw **0.TPC08** to attach to face frame
 Use screw **0.FPC06** to attach to screw-on hinge to door

Hinges

COMPACT CLIP 30C2 FACE FRAME HINGES, 105 DEGREES OPENING, (7/16" CUP DEPTH),

Overlay Face Frame Hinge With Blumotion Soft-Close, 105 Degrees opening, 7/16" cup depth, Screw-on, Nickel, 250/Case



SKU	Overlay	Style	Each	Case Qty	Case	10case
B.30C255BS06	3/8"	Screw-On	\$4.45	250	\$3.72	\$3.18
B.30C255BS08	1/2"	Screw-On	\$4.45	250	\$3.72	\$3.18
B.30C255BS10	5/8"	Screw-On	\$4.45	250	\$3.72	\$3.18
B.30C255BS12	3/4"	Screw-On	\$4.45	250	\$3.72	\$3.18
B.30C258BS05	5/16"	Press in	\$4.60	250	\$4.84	\$3.29
B.30C258BS06	3/8"	Press in	\$4.60	250	\$3.84	\$3.29
B.30C258BS07	7/16"	Press-in	\$4.60	250	\$3.84	\$3.29
B.30C258BS08	1/2"	Press-in	\$4.60	250	\$3.84	\$3.29
B.30C258BS10	5/8"	Press-in	\$4.60	250	\$3.84	\$3.29
B.30C258BS12	3/4"	Press-in	\$4.60	250	\$3.84	\$3.29
Edge Mount						
B.30C255BSE8	1/2"	Screw-On	\$4.45	250	\$3.72	\$3.18
B.30C258BSE8	1/2"	Press-In	\$4.60	250	\$3.84	\$3.29

Recommended Screws: 0.FPC06

COMPACT CLIP 30C, COVER CAPS, LIGHT GRAY, BLANK



SKU	Each	Case Qty	Case
B.30C2508	\$0.21	200	\$0.17
B.30C2508.BL	\$0.38	1000	\$0.32

Recommended Screws:

KOMPAKT SOFT_CLOSE FACE FRAME HINGES,

Kompakt SIMPLE (ET64 1/2" overlay 6-WAY) Face Frame Standard Hinges, 105-degree opening, Screw-on 200/Case



SKU	Overlay	Style	Each	Case Qty	Case
FGV.ET647112GG	1/2"	Screw-On	\$0.96	200	\$0.81
FGV.ET657112GG	1/2"	Screw-On	\$3.22	200	\$2.69
FGV.ET657142GG	1/2"	Press-In	\$2.42	200	\$2.02
FGV.ET897111GG	1-1/4"	Screw-On	\$3.22	300	\$2.69
FGV.ET897141GG	1-1/4"	Press-In	\$2.62	300	\$1.87

Use screw 0.TPC08 to attach to face frame
Use screw 0.FPC06 to attach to screw-on hinge to door

Compact Clip Face frame Hinges, 110 Degrees Opening

COMPACT CLIP 31C 1" Overlay Face Frame Hinge With Blumotion Soft-Close, 110 Degrees opening, 1/2" cup depth, Screw-On, Nickel, 250/Case



SKU	Overlay	Style	Each	Case Qty	Case	10case
B.31C355BS16	1"	Screw-On	\$4.59	250	\$3.84	\$3.29
B.31C355BS20	1-1/4"	Screw-On	\$4.59	250	\$3.84	\$3.28
B.31C355BS21	1-5/16"	Screw-On	\$4.59	250	\$3.83	\$3.28
B.31C355BS22	1-3/8"	Screw-On	\$4.59	250	\$3.83	\$3.38
B.31C355BS24	1-1/2"	Screw-On	\$4.59	250	\$3.83	\$3.38
B.31C358BS16	1"	Press-In	\$4.74	250	\$3.96	\$3.39
B.31C358BS20	1-1/4"	Press-In	\$4.74	250	\$3.96	\$3.39
B.31C358BS21	1-5/16"	Press-In	\$4.74	250	\$3.96	\$3.39
B.31C358BS22	1-3/8"	Press-In	\$4.74	250	\$3.96	\$3.39
B.31C358BS24	1-1/2"	Press-In	\$4.74	250	\$3.96	\$3.39
B.31C358BS25	1-9/16"	Press-In	\$4.74	250	\$3.96	\$3.39

Recommended Screws: 0.FPC06



OMNIA (FACE FRAME/CAM

Adjustable mounting plates) To be used with OMNIA + SC Hinges

SKU	Overlay	Style	Each	Case Qty	Case
FGV.52FR44M51005	0mm	Adjustable	\$1.02	200	\$0.85
FGV.52FR44M51305	3mm	Adjustable	\$1.08	200	\$0.90
FGV.52RR01L9000	0mm	Frameless	\$0.40	500	\$0.33
FGV.52RR16L900B	0mm	Frameless	\$0.48	500	\$0.40



OMNIA +SC Hinges (AnyClick / Soft-Close / CAM Adjustment) Face Frame Hinges, 110-degree opening, Screw-on 250/Case

SKU	Style	Each	Case Qty	Case
FGV.51R5H5M900CX	Screw-On	\$3.82	250	\$3.19
FGV.51R5H5M915CX	Srew-On	\$ 4.82	250	\$4.02

Custom Service Hardware®

Cast Metal Pulls & Knobs

Screws Not Included;
Recommended Screw: 0.TCM0832***Z



\$0.53 Special Offer
While Supplies Last!
Polished Brass

As Low As **\$0.60**
While Supplies Last!
Black Iron

Cup Pulls, 3" CC

SKU	Finish	Price Per Each	
		Each	100-ct
53.30343.03	Antique Brass	\$1.19	WSL
53.30343.08M	Matte Black	\$1.99	\$1.59
53.30343.08W	Black Iron	\$.99	\$0.89
53.30343.09B	Brushed Nickel	\$2.39	\$1.99
53.30343.18	Gray Iron	\$0.99	WSL

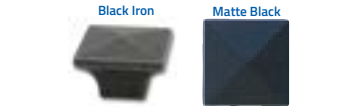

Square Knob, 1 1/4" x 1 1/4"

SKU	Finish	Price Per Each	
		Each	100-ct
50.38322.082	Black Iron	\$2.15	\$1.72
50.38322.08M	Matte Black	\$1.76	\$1.45



Swivel Bail Pull, 3" CC

SKU	Finish	Price Per Each	
		Each	100-ct
53.36152.082	Black Iron	\$2.58	\$2.06
53.36152.08M	Matte Black	\$2.31	\$1.85



Drop Pull, 56mm CC

SKU	Finish	Price Per Each	
		Each	100-ct
53.36151.05	Ant. Copper	\$0.38	WSL
53.36151.082	Black Iron	\$1.39	\$1.09
53.36151.08M	Matte Black	\$1.39	\$1.09
53.36151.18	Gray Iron	\$0.99	WSL



Wire Pulls, 3" CC

SKU	Finish	Price Per Each	
		Each	100-ct
52.35004.06*	Polished Brass	\$1.19	\$0.99

*96mm CC



Drop Pull

SKU	Finish	Price Per Each	
		Each	100-ct
53.37536.05	Ant. Copper	\$0.29	WSL



Knob, 1 1/4" Diameters

SKU	Finish	Price Per Each	
		Each	100-ct
50.308.03	Antique Brass	\$0.85	\$0.65
50.308.06	Polished Brass	\$1.44	\$1.29
50.308.07D	Dark Brown	\$0.35	WSL
50.308.08M	Matte Black	\$1.40	\$1.13
50.308.08W	Black Iron	\$1.35	\$.99
50.308.09B	Brushed Nickel	\$1.51	\$1.22

KREG TOOL CABINET HARDWARE JIG

Features:

- Adjustable guides for accurate hole placement
- Built-in measuring scales for repeatable results
- Versatile for mounting single and multi-hole knobs
- Strong, lightweight materials for easy handling
- Durable hardened-steel drill guides



SKU	Price
KT.KHI-PULL	\$2.00

Decorative Pulls & Knobs

Satin Pewter



Deco Knob & Pull

Price Per Each

SKU	Size	Case Qty	Each	Case
Knob				
*50.K81353.APH	32mm	250	\$1.82	\$1.46
Pull				
*52.P86765.APH	3" CC	250	\$2.04	\$1.66



Deco Knob & Pull

Price Per Each

SKU	Size	Case Qty	Each	Case
Knob				
*50.K86618.APH	65mm	250	\$2.23	\$1.78
Pull				
*52.P86718.APH	128mm CC	250	\$4.24	\$3.45



Rope Knob & Deco Bow Pull

Price Per Each

SKU	Size	Case Qty	Each	Case
Pull				
*52.P81297.APH	96mm CC	250	\$2.54	\$2.07

Flat Black



Spherical Knob & Arch Pull

Price Per Each

SKU	Size	Case Qty	Each	Case
Knob				
*50.K971.BK	1 3/8"	250	\$1.61	\$1.31
Pull				
*52.P50M.BK	128mm CC	250	\$3.03	\$2.46



Hooded Shaker Cup Pull

Price Per Each

SKU	Size	Case Qty	Each	Case
*52.P8233.BK	3" CC	250	\$3.01	\$2.44



Decorative Pull

Price Per Each

SKU	Size	Case Qty	Each	Case
*52.P1011.BK	3" CC	250	\$3.43	\$2.79

Satin Nickel



Deco Knob & Pull

Price Per Each

SKU	Size	Case Qty	Each	Case
Knob				
*50.K80110.SN	30mm	250	\$1.50	\$1.20
Pull				
*52.P80281.SN	96mm CC	250	\$3.39	\$2.76



Football Knob & Bow Pull w/Narrow Middle

Price Per Each

SKU	Size	Case Qty	Each	Case
Knob				
*50.K83990.SN	1 1/4"	250	\$1.99	\$1.60
Pull				
*52.P4655.SN	128mm CC	250	\$2.93	\$2.38



Decorative Pull

Price Per Each

SKU	Size	Case Qty	Each	Case
*52.P954.SN	3" CC	250	\$2.93	\$2.38



Decorative Pull

Price Per Each

SKU	Size	Case Qty	Each	Case
*52.P50S.SN	96mm CC	250	\$2.67	\$2.17

Antique Silver

Decorative Knob

Price Per Each

SKU	Size	Case Qty	Each	Case
*50.K928.SIM	31mm	250	\$2.20	\$1.76

*Screws not included.
Recommended Screw: [0.TCM0832](#)

Weathered Nickel

Deco Knob

Price Per Each

SKU	Size	Case Qty	Each	Case
*50.K972.BNMDL	30mm	250	\$1.79	\$1.44



Decorative Pull

Price Per Each

SKU	Size	Case Qty	Each	Case
*52.P847.BNMDL	3" CC	250	\$2.39	\$1.94



Rope Pull

Price Per Each

SKU	Size	Case Qty	Each	Case
*52.P955.BNMDL	3" CC	250	\$2.66	\$2.16

Weathered Black



Decorative Knob & Pull

Price Per Each

SKU	Size	Case Qty	Each	Case
Knob				
*50.K80980.DACM	32mm	250	\$2.34	\$1.97
Pull				
*52.P80290.DACM	3" CC	250	\$2.00	\$1.63



Square Knob & Deco Pull

Price Per Each

SKU	Size	Case Qty	Each	Case
Knob				
*50.K81091.DACM	32mm	250	\$1.79	\$1.44
Pull				
*52.P81092.DACM	96mm CC	250	\$2.69	\$2.19

Diecast Knob

Price Per Each

SKU	Size	Case Qty	Each	Case
*50.K910.DACM	30mm	250	\$1.33	\$1.07

Antique Satin Brass



Rope Knob & Deco Pull

SKU	Size	Case Qty	Price Per Each	
			Each	Case
Knob				
*50.K972.ABSB	30mm	250	\$1.85	\$1.48
Pull				
*52.P81366.ABSB	96mm CC	250	\$2.39	\$1.94



Deco Knob & Bin Pull

SKU	Size	Case Qty	Price Per Each	
			Each	Case
Knob				
*50.K80960.ABSB	32mm	250	\$1.30	\$1.04

Oil Rubbed Bronze



Deco Knob & Pull

SKU	Size	Case Qty	Price Per Each	
			Each	Case
Knob				
*50.K80576.10B	30mm	250	\$1.58	\$1.32
Pull				
*52.P80008.10B	3" CC	250	\$1.85	\$1.50



Braided Knob & Pull

SKU	Size	Case Qty	Price Per Each	
			Each	Case
Knob				
*50.K82115.10B	32mm	250	\$1.50	\$1.20
Pull				
*52.P83063.10B	3" CC	250	\$2.20	\$1.79



Cup Pull

SKU	Size	Case Qty	Price Per Each	
			Each	Case
*52.P953.10B	3" CC	250	\$3.35	\$2.72



Decorative Pull

SKU	Size	Case Qty	Price Per Each	
			Each	Case
*52.P433.10B	3" CC	250	\$1.23	\$1.00

*Screws not Included.
Recommended Screw: 0.TCM0832

Multiple Finish Options



SKU	Finish	Case Qty	Price Per Each	
			Each	Case
Square Bar Pull, 3 3/4" CC, 4 3/16" Overall				
52.P87226.10B	Oil Rubbed Bronze	250	\$4.07	\$3.70
52.P87226.BK	Black	250	\$3.75	
52.P87226.PC	Polished Chrome	250	\$4.46	\$3.62
52.P87226.RG	Rose Gold	250	\$4.76	\$3.87
52.P87226.SN	Satin Nickel	250	\$4.46	\$3.62

SKU	Finish	Case Qty	Price Per Each	
			Each	Case
Square Bar Pull, 5" CC, 5 7/16" Overall				
52.P87227.10B	Oil Rubbed Bronze	200	\$4.98	\$4.53
52.P87227.BK	Black	200	\$5.17	
52.P87227.PC	Polished Chrome	200	\$5.41	\$4.40
52.P87227.RG	Rose Gold	200	\$5.82	4.73
52.P87227.SN	Satin Nickel	200	\$5.41	\$4.40

SKU	Finish	Case Qty	Price Per Each	
			Each	Case
Square Bar Pull, 6.3" CC, 6 11/16" Overall				
52.P87228.10B	Oil Rubbed Bronze	100	\$6.09	\$4.95
52.P87228.BK	Black	100	\$5.87	\$5.87
52.P87228.PC	Polished Chrome	100	\$5.97	\$4.85
52.P87228.RG	Rose Gold	100	\$6.93	\$5.63
52.P87228.SN	Satin Nickel	100	\$5.98	\$4.86

SKU	Finish	Case Qty	Price Per Each	
			Each	Case
Square Bar Pull, 7.5" CC, 7 15/16" Overall				
52.P87229.10B	Oil Rubbed Bronze	100	\$7.89	\$6.41
52.P87229.PC	Polished Chrome	100	\$7.71	\$6.26
52.P87229.SN	Satin Nickel	100	\$8.64	\$7.02

SKU	Finish	Case Qty	Price Per Each	
			Each	Case
Square Bar Pull, 8.8" CC, 9 3/16" Overall				
52.P87300.10B	Oil Rubbed Bronze	50	\$8.77	\$7.13
52.P87300.SN	Satin Nickel	50	\$8.55	\$6.95



SKU	Finish	Case Qty	Price Per Each	
			Each	Case
Pull, 3" CC, 3 1/2" Overall				
*52.470.SI	Swedish Iron	500	\$1.19	\$0.95
*52.470.SN	Satin Nickel	500	\$1.30	\$1.09
*52.470.WEN	Weathered Nickel	500	\$1.37	\$1.14



SKU	Finish	Case Qty	Price Per Each	
			Each	Case
Pull, 3" CC, 5 5/8" Overall				
*52.6184.MB	Matte Black	500	\$3.64	\$3.03
*52.6184.OB	Oil Rubbed Bronze	500	\$1.31	\$1.09
*52.6184.SN	Satin Nickel	500	\$1.31	\$1.09
*52.6184.WEN	Weathered Nickel	500	\$1.28	\$1.07



SKU	Finish	Case Qty	Price Per Each	
			Each	Case
Pull, 3" CC, 5 3/4" Overall				
*52.6465.SN	Satin Nickel	250	\$2.00	\$1.67



SKU	Finish	Case Qty	Price Per Each	
			Each	Case
Pull, 3" CC, 5 3/4" Overall				
*52.6954R.MB	Matte Black	250	\$2.05	\$1.79
*52.6954R.OB	Oil Rubbed Bronze	250	\$2.59	\$2.18
*52.6954R.SN	Satin Nickel	250	\$3.06	\$2.89
*52.6954R.WEN	Weathered Nickel	250	\$2.06	\$1.72



SKU	Finish	Case Qty	Price Per Each	
			Each	Case
Knobs, 1 1/4" Diameter				
*50.6971.MB	Matte Black	250	\$2.62	\$2.19
*50.6971.OB	Oil Rubbed Bronze	250	\$2.11	\$1.99
*50.6971.SI	Swedish Iron	250	\$2.28	\$1.99
*50.6971.SN	Satin Nickel	250	\$1.89	\$1.58

*Screws not Included.
Recommended Screw: 0.TCM0832



Decorative Hardware

Oil Rubbed Bronze



Satin Nickel



Victorian Decorative Knobs

SKU	Finish	Size	Case Qty	Price Per Each	
				Each	Case
*50.460.OB	Oil Rubbed Bronze	1 1/4" Diameter	250	\$1.79	\$1.49
*50.460.SN	Satin Nickel	1 1/4" Diameter	250	\$2.04	\$1.49

Polished Chrome



Matte Black



Simple Decorative Knobs

SKU	Finish	Size	Case Qty	Price Per Each	
				Each	Case
*50.3910.MB	Matte Black	1 1/4" Diameter	500	\$1.35	\$1.08
*50.3910.PC	Polished Chrome	1 1/4" Diameter	500	1.26	0.99

Matte Black



Weathered Nickel



Oil Rubbed Bronze



Eden Decorative Knobs

SKU	Finish	Size	Case Qty	Price Per Each	
				Each	Case
*50.6464R.MB	Matte Black	1 1/4" Diameter	250	\$2.08	\$1.74
*50.6464R.OB	Oil Rubbed Bronze	1 1/4" Diameter	250	\$1.74	\$1.46
*50.6464R.WEN	Weathered Nickel	1 1/4" Diameter	250	\$2.28	\$1.99



Oil Rubbed Bronze



Satin Nickel

Classic Decorative Knobs

SKU	Finish	Size	Case Qty	Price Per Each	
				Each	Case
*50.480.OB	Oil Rubbed Bronze	1 1/4" Diameter	500	\$1.43	\$1.19
*50.480.SN	Satin Nickel	1 1/4" Diameter	500	\$1.86	\$1.55

Classic Knobs and Pulls



Porcelain Knob

SKU	Finish	Size	Each
*HH.P28-W	White	1 1/4"	\$2.58



Antique Brass Knob

SKU	Finish	Size	Price Per Each	
			Each	100
*50.10.03	Antique Brass	1 1/4"	\$0.44	\$0.35



Knob w/Oak Center

SKU	Finish	Size	Price Per Each	
			Each	100
*50.18.20	Antique English	1 1/4"	\$0.59	\$0.43



Antique English Knob

SKU	Finish	Size	Price Per Each	
			Each	100
*50.14.20	Antique English	1 1/4"	\$0.41	\$0.30



Door Handle, Antique Brass, 5.5" Overall Length

SKU	Price Per Each	
	Each	100
*52.05.03	\$1.27	\$1.03

3" Center-to-Center



Door Handle w/Oak Center

SKU	Finish	Length	CC	Price Per Each	
				Each	100
*52.09.06	Polished Brass	5" O/A	3"	\$1.04	\$0.75
*52.09.20	Antique English	5" O/A	3"	\$1.29	\$0.99

*Screws Not Included.
Recommended Screw: 0.TCM0832



Oak Wooden Pull, Flush

SKU	Finish	Length	CC	Price Per Each	
				Each	100
*55.18	Oak	4.5" O/A	3 3/4"	\$2.61	\$1.95

*Mounts with a #8-32 Machine Screw.

Wire Pulls



Available Finishes:

Code	Finish	Code	Finish
02	Chrome	06B	Brushed Brass
02B	Brushed Chrome	ORB	Oil Rubbed Bronze
06	Polished Brass	08M	Matte Black

Screws Not Included.
Recommended Screw: 0.TCM0832

SKU	Size	Price Per Each		
		Each	100	250
52.24.*	3" CC	\$0.84	\$0.76	\$0.70
52.25.**	3 1/2" CC	\$0.86	\$0.78	\$0.72
52.26.*	4" CC	\$0.99	\$0.89	\$0.79
52.26.06B	4" CC	\$0.99	\$0.89	\$0.79
52.27.*	5" CC	\$1.46	\$1.32	\$1.24
52.28.*	96mm CC	\$0.90	\$0.82	\$0.75

*Choose Finish

**Not Available in (08M)Matte Black

Other finishes are available. Call for a quote (minimums may apply).

Jigs & Handle Installation Guides

Self-Centering Drawer Handle & Knob Jig



Comes With Two Insert Guides:

Standard Insert: 3", 3 1/2" & 5" CC
Metric Insert: 64mm, 96mm, & 128mm CC
(Custom Insert Guide Available).

- Solid construction easily withstands the daily abuses
- Fits drawers that are 6 1/2" to 28 1/2" W & 3 1/2" to 14 1/2" H
- Comes with two extension paddles for drawers under 10 1/2" W
- Custom drill guides & longer arms are available upon request

999.DJ Handle & Knob Jig \$365.00

Cabinet Hardware Jig



The centered drill guide location for knobs is 1" to 5". The guide spacing for pulls is 2 1/2" to 5" CC.

- 3/16" Drill bit is required but not included.
- Adjustable guides for accurate hole placement
- Built-in measuring scales for repeatable results
- Versatile for mounting single and multi-hole knobs
- Adjustable edge guide for easy positioning
- Durable hardened-steel drill guides

KT.KHI-PULL \$29.99

Door Hardware Jig



- Move the stops along the guide to the desired position.
- Tighten the thumb screws and drill. It allows for positioning of knobs or handles with a maximum of 12" CC down to 1 1/8" CC.
- It comes with one true-position drill guide, two sliding guides with thumb screws & one end stop with thumb screw.
- Reversible for left or right handed doors.

999.1934 TP-1934 Hardware Jig \$249.00
999.2312 Line-Boring Extensions \$159.00
999.5MMB 5mm Bit \$14.99

Knob & Handle Installation Guides for Doors & Drawers



- Two alignment guides for knobs & handles
- 3/16" Drill bit
- All standard handle spans
- Measure & mark for horizontal & vertical
- Accurate, inexpensive & simple

HH.PBH3103 Installation Guides \$10.44

Steel Bar Pulls

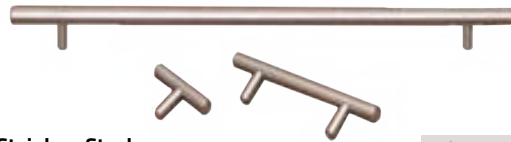

Bar Pulls, Stainless Steel

SKU	O/A Length	Center-Center	Case Qty	Price Per Each	
				Each	Case
*50.K102.SS (Knob)	2 3/8"	N/A	250	\$2.83	\$2.27
*52.P105.SS	5 1/2"	3"	100	\$7.96	\$6.47
*52.P1096.SS	6 1/8"	96mm CC	100	\$8.18	\$7.08
*52.P107.SS	7 7/16"	128mm CC	75	\$9.67	\$7.86
*52.P109.SS	9 7/8"	192mm CC	50	\$11.38	\$9.24
*52.P113.SS	13 1/4"	256mm CC	40	\$13.66	\$11.09
*52.P115.SS	15 3/4"	320mm CC	30	\$16.31	\$13.25
*52.P119.SS	19 1/2"	416mm CC	30	\$19.91	\$16.18
*52.P122.SS	22"	480mm CC	25	\$21.81	\$17.72
*52.P124.SS	24 1/2"	544mm CC	20	\$23.70	\$19.26
*52.P128.SS	28 1/4"	640mm CC	20	\$27.50	\$22.34
*52.P133.SS	33 1/4"	768mm CC	20	\$32.11	\$26.09

Solid Steel Bar Pulls, 12mm Diameter, Satin Nickel

SKU	O/A Length	Center-Center	Case Qty	Price Per Each	
				Each	Case
*50.K102.SN (Knob)	2"	N/A	250	\$1.22	\$0.97
*52.P1096.SN	152mm	96mm CC	100	\$2.27	\$1.84
*52.P106.SN	6"	3" CC	100	\$2.27	\$1.84
*52.P108.SN	8"	5" CC	50	\$3.04	\$2.47
*52.P110.SN	10"	7" CC	50	\$3.62	\$2.94
*52.P112.SN	12"	9" CC	50	\$3.88	\$3.53
*52.P114.SN	14"	11" CC	30	\$5.06	\$4.12
*52.P116.SN	16"	13" CC	30	\$6.03	\$4.90
*52.P118.SN	18"	15" CC	30	\$7.02	\$5.70
*52.P120.SN	20"	17" CC	30	\$7.39	\$6.01
*52.P122.SN	22"	19" CC	25	\$7.93	\$6.44
*52.P124.SN	24"	21" CC	20	\$8.53	\$6.93
*52.P126.SN	26"	23" CC	20	\$9.29	\$7.55
*52.P128.SN	28"	25" CC	20	\$10.05	\$8.17
*52.P130.SN	30"	27" CC	20	\$10.81	\$8.78

*Screws not Included.
Recommended Screw: 0.TCM0832

Unfinished Wood Knobs



Knob w/8-32 Machine Screw Insert

1 1/8" Diameter, Unfinished Face Grain

SKU	Species	Project.	Each
*55.11R.01	Red Oak	1"	\$1.77
*55.11R.03	Pine	1"	\$1.77
*55.11R.05	Cherry	1"	\$1.77
*55.11R.07	Walnut	1"	\$3.00
*55.11R.09	Hickory	1"	\$1.77
*55.11R.11	Maple	1"	\$1.77
*55.11R.13	Bird's Eye	1"	\$3.00



Knob w/8-32 Machine Screw Insert

1 1/8" Diameter, Unfinished Face Grain

SKU	Species	Project.	Each
*55.110T.01	Red Oak	1"	\$1.86
*55.110T.03	Pine	1"	\$1.86
*55.110T.05	Cherry	1"	\$1.86
*55.110T.07	Walnut	1"	\$3.00
*55.110T.09	Hickory	1"	\$1.86
*55.110T.11	Maple	1"	\$1.86
*55.110T.13	Bird's Eye	1"	\$3.00



Knob w/8-32 Machine Screw Insert

1 1/2" Diameter, Unfinished Face Grain

SKU	Species	Project.	Each
*55.15R.01	Red Oak	1 1/8"	\$1.92
*55.15R.03	Pine	1 1/8"	\$2.35
*55.15R.05	Cherry	1 1/8"	\$1.99
*55.15R.07	Walnut	1 1/8"	\$3.11
*55.15R.09	Hickory	1 1/8"	\$1.99
*55.15R.11	Maple	1 1/8"	\$1.99
*55.15R.13	Bird's Eye	1 1/8"	\$3.11



Knob w/8-32 Machine Screw Insert

1 1/2" Diameter, Unfinished Face Grain

SKU	Species	Project.	Each
*55.150T.01	Red Oak	1 1/8"	\$2.05
*55.150T.03	Pine	1 1/8"	\$2.05
*55.150T.05	Cherry	1 1/8"	\$2.05
*55.150T.07	Walnut	1 1/8"	\$3.11
*55.150T.09	Hickory	1 1/8"	\$2.00
*55.150T.11	Maple	1 1/8"	\$2.00
*55.150T.13	Bird's Eye	1 1/8"	\$3.11



Knob w/8-32 Machine Screw Insert

1 3/4" Diameter, Unfinished Face Grain

SKU	Species	Project.	Each
*55.17R.01	Red Oak	1 3/16"	\$2.05
*55.17R.03	Pine	1 3/16"	\$2.05
*55.17R.05	Cherry	1 3/16"	\$2.05
*55.17R.07	Walnut	1 3/16"	\$3.34
*55.17R.09	Hickory	1 3/16"	\$2.00
*55.17R.11	Maple	1 3/16"	\$2.00
*55.17R.13	Bird's Eye	1 3/16"	\$3.34

*Screws not Included
Recommended Screw:
0.TCM0832



Steel Arch Pulls



Stainless Steel Arch Pulls

- Brushed finish is durable and easy to clean
- Includes: (Two) #8-32 x 1" mounting screws

SKU	Dimensions	Price Per Each	
		Each	100
52.AP030.SS	30mm CC	\$4.91	\$4.27
52.AP096.SS	96mm CC	\$5.96	\$4.97
52.AP128.SS	128mm CC	\$7.34	\$6.67
52.AP160.SS	160mm CC	\$8.30	\$6.92
52.AP192.SS	192mm CC	\$10.06	\$8.38

Maple Knob w/Insert

1 1/4" Diameter Price Per Each

SKU	Proj	Each	100-ct
+55.01M	1 3/16"	\$1.28	\$1.06

1 1/4" Diameter Price Per Each

SKU	Proj	Each	100
+55.12-BR.MA	1 1/18"	\$1.89	\$1.55

1 1/2" Diameter Price Per Each

SKU	Proj	Each	100
+55.107.10	1 5/16"	\$1.68	\$1.40

1 1/2" Diameter Price Per Each

SKU	Proj	Each	100
+55.110.10	1 5/64"	\$1.37	\$1.14

1 1/2" Diameter Price Per Each

SKU	Proj	Each	100
+55.05	1 3/16"	\$1.01	\$0.84

Cherry Knob w/Insert

1" Diameter Price Per Each

SKU	Proj	Each	100
+55.08	1 5/16"	\$1.10	\$0.91

1 1/4" Diameter Price Per Each

SKU	Proj	Each	100
+55.12-BR.CH	1 1/8"	\$1.89	\$1.55

1 1/2" Diameter Price Per Each

SKU	Proj	Each	100
+55.06	1 3/16"	\$1.01	\$0.84

1 1/2" Diameter Price Per Each

SKU	Proj	Each	100
+55.112.13	1 1/4"	\$1.68	\$1.40

Oak Knob w/Insert

1" Diameter Price Per Each

SKU	Proj	Each	100-ct
+55.03	1 3/16"	\$1.00	\$0.89

1 1/4" Diameter Price Per Each

SKU	Proj	Each	100
+55.102.8	7/8"	\$1.10	\$0.91

1 1/4" Diameter Price Per Each

SKU	Proj	Each	100
+55.12-BR.RO	1 1/8"	\$1.89	\$1.55

1 1/4" Diameter Price Per Each

SKU	Proj	Each	100-ct
+55.02	1 3/16"	\$1.00	\$0.89

1 1/2" Diameter Price Per Each

SKU	Proj	Each	100-ct
+55.04	1 3/16"	\$1.07	\$0.88

*Screws not Included.
Recommended Screw: 0.TCM0832



Coat Hooks

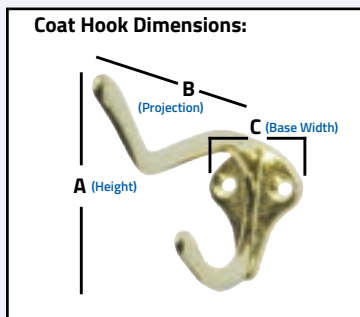

Coat Hook, Polished Brass

SKU	Dimensions			Price p/Each	
	A	B	C	Each	100
+56.051.06	2.50"	3.00"	1.10"	\$0.82	\$0.61

Coat Hook, Polished Brass

SKU	Dimensions			Price p/Each	
	A	B	C	Each	100
+56.055.06	1.70"	1.20"	.70"	\$0.82	\$0.61

Coat Hook, Brushed Nickel

SKU	Dimensions			Price p/Each	
	A	B	C	Each	100
+56.055.09B	1.70"	1.20"	.70"	\$0.78	\$0.66

Coat Hook, Polished Brass

SKU	Dimensions			Price p/Each	
	A	B	C	Each	100
+56.063.06	3.30"	2.30"	.80"	\$1.86	\$1.51

Coat Hook, Brushed Nickel

SKU	Dimensions			Price p/Each	
	A	B	C	Each	100
+56.063.09B	3.30"	2.30"	.80"	\$2.40	\$2.00

Coat Hook, Polished Brass

SKU	Dimensions			Price p/Each	
	A	B	C	Each	100
+56.067B.06	2.00"	.75"	.80"	\$2.52	\$2.10

Front-Mounted Coat Hook, Antique Brass

SKU	Dimensions			Price p/Each	
	A	B	C	Each	100
+56.31.03	5.50"	4.10"	1.00"	\$7.06	\$5.64

*Screws not Included.
Recommended Screw: 0.FPC06034



Zinc Coat Hook, Antique Brass

SKU	Dimensions			Each
	A	B	C	
HH.P27120-AB	3"	2 7/8"	1"	\$5.18

Zinc Coat Hook, Black

SKU	Dimensions			Each
	A	B	C	
HH.P27120-BL	3"	2 7/8"	1"	\$5.18

Zinc Coat Hook, Chrome

SKU	Dimensions			Each
	A	B	C	
HH.P27120-CH	3"	2 7/8"	1"	\$5.18

Zinc Coat Hook, Polished Brass

SKU	Dimensions			Each
	A	B	C	
HH.P27120-PB	3"	2 7/8"	1"	\$5.18

Zinc Coat Hook, Satin Chrome

SKU	Dimensions			Each
	A	B	C	
HH.P27120-SC	3"	2 7/8"	1"	\$5.18

Zinc Coat Hook, White

SKU	Dimensions			Each
	A	B	C	
HH.P27120-W	3"	2 7/8"	1"	\$5.18

Pride Industrial®

Appliques & Medallions



Hand Carved Onlay

SKU	Type	Each
20" x 4" x 3/4"		
PI.ONLAY-1-S-CH	Cherry	\$56.41
PI.ONLAY-1-S-MP	Maple	\$50.24
PI.ONLAY-1-S-RO	Red Oak	\$28.62
PI.ONLAY-1-S-AL	Alder	\$48.96
PI.ONLAY-1-S-RW	Rubberwood	\$39.17
24" x 5" x 3/4"		
PI.ONLAY-1-M-CH	Cherry	\$73.54
PI.ONLAY-1-M-MP	Maple	\$39.44
PI.ONLAY-1-M-RO	Red Oak	\$38.01
PI.ONLAY-1-M-AL	Alder	\$38.01
PI.ONLAY-1-M-RW	Rubberwood	\$61.30
36" x 7 1/2" x 7/8"		
PI.ONLAY-1-L-CH	Cherry	\$78.83
PI.ONLAY-1-L-MP	Maple	\$118.88
PI.ONLAY-1-L-RO	Red Oak	\$116.43
PI.ONLAY-1-L-AL	Alder	\$68.07
PI.ONLAY-1-L-RW	Rubberwood	\$60.17



Hand Carved Onlay

SKU	Type	Each
20" x 4 1/2" x 3/4"		
PI.ONLAY-2-S-CH	Cherry	\$32.97
PI.ONLAY-2-S-MP	Maple	\$29.37
PI.ONLAY-2-S-RO	Red Oak	\$48.96
PI.ONLAY-2-S-AL	Alder	\$48.96
PI.ONLAY-2-S-RW	Rubberwood	\$39.17
24" x 5" x 3/4"		
PI.ONLAY-2-M-CH	Cherry	\$42.99
PI.ONLAY-2-M-MP	Maple	\$67.47
PI.ONLAY-2-M-AL	Alder	\$38.01
PI.ONLAY-2-M-RW	Rubberwood	\$61.30
36" x 7 1/2" x 7/8"		
PI.ONLAY-2-L-CH	Cherry	\$78.83
PI.ONLAY-2-L-MP	Maple	\$118.88
PI.ONLAY-2-L-RO	Red Oak	\$68.07
PI.ONLAY-2-L-AL	Alder	\$68.07
PI.ONLAY-2-L-RW	Rubberwood	\$101.65

Corbels & Supports



Acanthus Corbel

SKU	Type	Each
4 5/8" x 5 1/4" x 10", Small		
PI.CORBEL-A-1-CH	Cherry	\$73.66
PI.CORBEL-A-1-MP	Maple	\$107.20
PI.CORBEL-A-1-RO	Red Oak	\$61.01
PI.CORBEL-A-1-AL	Alder	\$104.36
PI.CORBEL-A-1-RW	Rubberwood	\$88.36
5" x 7" x 14", Medium		
PI.CORBEL-A-2-CH	Cherry	\$99.48
PI.CORBEL-A-2-MP	Maple	\$152.31
PI.CORBEL-A-2-RO	Red Oak	\$86.85
PI.CORBEL-A-2-AL	Alder	\$86.85
PI.CORBEL-A-2-RW	Rubberwood	\$123.91
6 3/4" x 7 3/4" x 22", Large		
PI.CORBEL-A-3-CH	Cherry	\$257.83
PI.CORBEL-A-3-MP	Maple	\$197.87
PI.CORBEL-A-3-RO	Red Oak	\$177.89
PI.CORBEL-A-3-AL	Alder	\$177.89
PI.CORBEL-A-3-RW	Rubberwood	\$235.90



Traditional Corbel

SKU	Type	Each
4 5/8" x 5 1/4" x 10", Small		
PI.CORBEL-T-1-CH	Cherry	\$70.68
PI.CORBEL-T-1-MP	Maple	\$97.60
PI.CORBEL-T-1-RO	Red Oak	\$93.85
PI.CORBEL-T-1-AL	Alder	\$93.85
PI.CORBEL-T-1-RW	Rubberwood	\$82.55
5" x 7" x 14", Medium		
PI.CORBEL-T-2-CH	Cherry	\$148.55
PI.CORBEL-T-2-MP	Maple	\$133.51
PI.CORBEL-T-2-RO	Red Oak	\$75.85
PI.CORBEL-T-2-AL	Alder	\$129.75
PI.CORBEL-T-2-RW	Rubberwood	\$105.11
6 3/4" x 7 1/2" x 22", Large		
PI.CORBEL-T-3-CH	Cherry	\$257.83
PI.CORBEL-T-3-MP	Maple	\$197.87
PI.CORBEL-T-3-RO	Red Oak	\$177.89
PI.CORBEL-T-3-AL	Alder	\$177.89
PI.CORBEL-T-3-RW	Rubberwood	\$235.90



Grape Corbel

SKU	Type	Each
4 1/2" x 5" x 10", Small		
PI.CORBEL-G-1-CH	Cherry	\$71.45
PI.CORBEL-G-1-MP	Maple	\$60.45
PI.CORBEL-G-1-RO	Red Oak	\$58.26
PI.CORBEL-G-1-AL	Alder	\$68.35
PI.CORBEL-G-1-RW	Rubberwood	\$50.02
5" x 7" x 14", Medium		
PI.CORBEL-G-2-CH	Cherry	\$107.63
PI.CORBEL-G-2-MP	Maple	\$81.90
PI.CORBEL-G-2-RO	Red Oak	\$80.05
PI.CORBEL-G-2-AL	Alder	\$92.51
PI.CORBEL-G-2-RW	Rubberwood	\$67.06
6 3/4" x 7 3/4" x 22", Large		
PI.CORBEL-G-3-CH	Cherry	\$313.30
PI.CORBEL-G-3-MP	Maple	\$218.76
PI.CORBEL-G-3-RO	Red Oak	\$196.76
PI.CORBEL-G-3-AL	Alder	\$196.76
PI.CORBEL-G-3-RW	Rubberwood	\$152.80



Mission Corbel 1

SKU	Type	Each
4 1/2" x 5" x 10", Small		
PI.CORBEL-M-5-MP	Maple	\$97.60
PI.CORBEL-M-5-RO	Red Oak	\$93.85
PI.CORBEL-M-5-AL	Alder	\$93.85
PI.CORBEL-M-5-RW	Rubberwood	\$82.55
5 1/4" x 7" x 14", Medium		
PI.CORBEL-M-6-MP	Maple	\$140.72
PI.CORBEL-M-6-AL	Alder	\$129.75
PI.CORBEL-M-6-RW	Rubberwood	\$106.90
6 3/4" x 7 3/4" x 22", Large		
PI.CORBEL-M-7-CH	Cherry	\$257.83
PI.CORBEL-M-7-MP	Maple	\$197.87
PI.CORBEL-M-7-RO	Red Oak	\$177.89
PI.CORBEL-M-7-AL	Alder	\$177.89
PI.CORBEL-M-7-RW	Rubberwood	\$137.91



Mission Corbel 2

SKU	Type	Each
2" x 5" x 8", Small		
PI.CORBEL-M-1-MP	Maple	\$46.68
PI.CORBEL-M-1-RO	Red Oak	\$31.23
PI.CORBEL-M-1-AL	Alder	\$43.67
PI.CORBEL-M-1-RW	Rubberwood	\$39.04
3" x 9" x 12", Medium		
PI.CORBEL-M-2-CH	Cherry	\$92.02
PI.CORBEL-M-2-MP	Maple	\$78.01
PI.CORBEL-M-2-RO	Red Oak	\$69.07
PI.CORBEL-M-2-AL	Alder	\$69.07
PI.CORBEL-M-2-RW	Rubberwood	\$58.49
2 1/2" x 6 1/2" x 12", Narrow		
PI.CORBEL-M-4-CH	Cherry	\$55.30
PI.CORBEL-M-4-MP	Maple	\$67.01
PI.CORBEL-M-4-RO	Red Oak	\$43.89
PI.CORBEL-M-4-AL	Alder	\$60.65
PI.CORBEL-M-4-RW	Rubberwood	\$55.10

"Pride Industrial is a premier manufacturer of hardware for the woodworking industry who firmly believes in top quality products and the most reliable service."

—Pride Industrial LLC



Pride Industrial

Ornamental®

Appliques & Medallions



Acanthus Center, Pressed Birch Face Plywood

SKU	Description	Case Qty	Price per Each	
			Each	Case
61.14020.PBIR	22" Width x 5 3/8" Length x 7/32" Thickness ²⁵	25	\$12.75	\$11.69



Empire Center Onlay, Pressed Birch Face Plywood

SKU	Description	Case Qty	Price per Each	
			Each	Case
61.3364.PBIR	16 1/16" W x 3 1/2" Length x 7/32" Thickness ²⁵	25	\$4.30	\$3.94

Tudor Rose, Pressed Birch Face Plywood



SKU	Size	Case Qty	Price per Pair	
			Pair	Case
61.3003.PBIR	2-1/2" W x 2-1/2" L x 7/32" Thickness	25	\$1.24	\$1.14



3 3/4" L x 3 3/4" W x 7/32" Thick Acanthus Corner Ornament, Pressed Birch Face Plywood

SKU	Case Qty	Price per Each	
		Each	Case
61.3319.PBIR	25	\$1.70	\$1.55



3 3/8" x 3 3/8" x 7/32" Thick Floral Corner Ornament, Pressed Birch Face Plywood

SKU	Case Qty	Price per Each	
		Each	Case
61.3087.PBIR	25	\$1.30	\$1.19



Standard Rope Twist Moulding (10 p/Box)

61.601928.MAP	Maple	3/4" W x 1 1/32" TH x 96" L	\$9.25
61.601928.OAK	Oak	3/4" W x 1 1/32" TH x 96" L	\$8.01



10 3/8" W x 3" L x 7/32" Thick Leaf Scrolls (Pair), Pressed Birch Face Plywood

SKU	Case Qty	Price per Pair	
		Pair	Case
61.3074.PBIR	25 Pairs	\$3.33	\$3.05



5 1/4" W x 1 3/4" L x 7/32" Thick Acanthus Scrolls (Pair), Pressed Birch Face Plywood

SKU	Case Qty	Price per Pair	
		Pair	Case
61.3017.PBIR	25 Pairs	\$2.88	\$2.64

1" Diameter x 7/32" Thick Wood Ornament, White Hardwood Plywood



SKU	Case Qty	Price per Each	
		Each	Case
61.3000.PBIR	25	\$.56	\$.46



Maple Shelf Bracket
5 3/4" D x 1 3/4" W x 9" H
(6) per Box

61.IM-BR.75X9 \$14.17

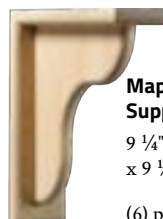

Maple Countertop Support Bracket

9 1/4" D x 2 1/2" W
x 9 1/4" H

(6) per Box

61.IM-CTS112A-MAPL \$15.59



Maple Corbel Premium

8" D x 3" W x 12" H
(6) per Box

61.CA.110.MA \$27.46

Mouldings & Corbels



Plain Wood Moulding (10 p/Box)

1/2" W x 1/4" TH x 96" L

61.597.MAP Hard Maple \$7.50



Plain Corner Wood Moulding (25 p/Box)

1/2" W x 1/4" TH x 2 3/16" L; 1 3/4" Radius
61.597A.MAP Hard Maple \$2.73

For hundreds of more options visit [cshardware.com/wood-and-concrete/wood-carvings](https://www.cshardware.com/wood-and-concrete/wood-carvings)

or scan QR code



White River®

Mon Reale Mouldings

The Mon Reale Collection is made from a fine grain overlay contoured to solid Poplar moulding that ships unfinished and can stain or paint. Frieze and Panel Mouldings have a flat back.

Cornice Mouldings



Large Poplar Acanthus Leaf & Tongue 8 Ft. Crown Moulding

Actual Dimensions: $\frac{7}{8}$ " x 6";
Installed Dimensions: 4 $\frac{3}{4}$ " H,
3 $\frac{3}{4}$ " Projection; Pattern Repeats 7"
[WR.CM8801POP](#) **\$151.30**



Medium Poplar Acanthus Leaf 8 Ft. Crown Moulding

Actual Dimensions: $1\frac{1}{16}$ " x 4 $\frac{3}{4}$ ";
Installed Dimensions: 3 $\frac{3}{4}$ " H,
4 $\frac{3}{4}$ " Projection; Pattern Repeats 4 $\frac{3}{4}$ "
[WR.CM8810POP](#) **\$166.45**



Medium Poplar Acanthus w/Egg & Dart 8 Ft. Crown Moulding

Actual Dimensions: 1" x 6";
Installed Dimensions: 4 $\frac{7}{8}$ " H,
3 $\frac{3}{4}$ " Projection
[WR.CM8812POP](#) **\$146.78**



Poplar Egg & Dart 8 Ft. Crown Moulding

Actual Dimensions: 1" x 3 $\frac{3}{4}$ ";
Installed Dimensions: 3" H,
2 $\frac{1}{2}$ " Projection; Pattern Repeats 3"
[WR.CM8823POP](#) **\$122.19**



Petite Poplar Acanthus Leaf 8 Ft. Crown Moulding

Actual Dimensions: $1\frac{3}{16}$ " x 2 $\frac{3}{4}$ ";
Installed Dimensions: 2 $\frac{1}{4}$ " H,
1 $\frac{3}{4}$ " Projection; Pattern Repeats 2 $\frac{7}{8}$ "
[WR.CM8820POP](#) **\$97.34**

Please note: Any moulding 8ft or longer incurs a \$90+ oversize shipping fee. CSH can NOT modify length to avoid shipping charges.



Large Poplar Rope 8 Ft. Crown Moulding

Actual Dimensions: $\frac{3}{4}$ " x 4";
Installed Dimensions: 3 $\frac{1}{8}$ " H,
2 $\frac{7}{16}$ " Projection
[WR.CM8834POP](#) **\$102.52**



Petite Poplar Acanthus w/ Egg & Dart 8 Ft. Crown Moulding

Actual Dimensions: $\frac{7}{8}$ " x 7";
Installed Dimensions: 5 $\frac{1}{4}$ " H,
4 $\frac{3}{4}$ " Projection
[WR.CM8837POP](#) **\$147.61**

Frieze & Panel Mouldings



Poplar Fluting 8 Ft. Crown Moulding

Actual Dimensions: $1\frac{1}{16}$ " x 3 $\frac{3}{4}$ ";
Pattern Repeats $\frac{7}{8}$ ";
Maximum Thickness: $\frac{3}{4}$ "
[WR.FR8920POP](#) **\$109.32**



Poplar Scrolled Palmette 8 Ft. Crown Moulding

Actual Dimensions: $1\frac{3}{16}$ " x 5 $\frac{1}{2}$ ";
Pattern Repeats 5";
Maximum Thickness: $1\frac{1}{16}$ "
[WR.FR8958POP](#) **\$163.48**

Large Poplar Scrolled Palmette 8 Ft. Crown Moulding

Actual Dimensions: $1\frac{3}{16}$ " x 6 $\frac{3}{4}$ ";
Pattern Repeats 7 $\frac{1}{2}$ ";
Maximum Thickness: $1\frac{3}{16}$ "
[WR.FR8967POP](#) **\$186.42**



Poplar Rinceau Scrolls 8 Ft. Crown Moulding

Actual Dimensions: $1\frac{3}{16}$ " x 5 $\frac{1}{2}$ ";
Pattern Repeats 11 $\frac{1}{2}$ ";
Maximum Thickness: $\frac{7}{8}$ "
[WR.FR8965POP](#) **\$174.16**



Poplar Running Leaf 8 Ft. Crown Moulding

Actual Dimensions: $1\frac{3}{16}$ " x 2";
Pattern Repeats 2 $\frac{1}{4}$ "
[WR.PM8511POP](#) **\$101.52**



Poplar Small Egg & Dart 8 Ft. Crown Moulding

Actual Dimensions: $\frac{3}{4}$ " x 1 $\frac{1}{2}$ ";
Pattern Repeats 1 $\frac{3}{4}$ "
[WR.PM8535POP](#) **\$75.12**

Poplar Large Egg & Dart 8 Ft. Crown Moulding

Actual Dimensions: 1" x 2 $\frac{3}{4}$ ";
Pattern Repeats 2 $\frac{3}{8}$ "
[WR.PM8536POP](#) **\$100.03**



Poplar Small Rope 8 Ft. Crown Moulding

Actual Dimensions: $\frac{5}{8}$ " x 1";
Pattern Repeats $\frac{3}{4}$ "
[WR.PM8540POP](#) **\$69.37**

Poplar Large Rope 8 Ft. Crown Moulding

Actual Dimensions: $\frac{7}{8}$ " x 1 $\frac{1}{2}$ ";
Pattern Repeats 1 $\frac{1}{4}$ "
[WR.PM8541POP](#) **\$77.24**



Poplar Small Acanthus 8 Ft. Crown Moulding

Actual Dimensions: $\frac{1}{2}$ " x 1"
[WR.PM8561POP](#) **\$72.98**

Poplar Medium Acanthus 8 Ft. Crown Moulding

Actual Dimensions: $\frac{7}{8}$ " x 2"
[WR.PM8560POP](#) **\$77.66**



Large Poplar Rinceau Scrolls 8 Ft. Crown Moulding

Actual Dimensions: $1\frac{3}{16}$ " x 6 $\frac{3}{4}$ ";
Pattern Repeats 13 $\frac{3}{8}$ ";
Maximum Thickness: $\frac{7}{8}$ "
[WR.FR8966POP](#) **\$186.42**

Ornamentally Embossed Mouldings

Cornice Mouldings



Poplar Egg & Dart 8 Ft. Crown Moulding

Actual Dimensions: $1\frac{3}{16}$ " x 3 $\frac{3}{4}$ ";
Installed Dimensions: 3" x 2 $\frac{7}{16}$ "
[WR.CM72POP](#) **\$65.63**



Poplar Dentil 8 Ft. Crown Moulding

Actual Dimensions: $1\frac{3}{16}$ " x 5 $\frac{1}{2}$ ";
Installed Dimensions: 4 $\frac{1}{2}$ " x 3 $\frac{3}{8}$ "
[WR.CM73POP](#) **\$117.89**



Poplar Bead with Dentil 8 Ft. Crown Moulding

Actual Dimensions: $1\frac{3}{16}$ " x 5 $\frac{1}{2}$ ";
Installed Dimensions: 4" x 3 $\frac{3}{8}$ "
[WR.CM75POP](#) **\$111.57**



Poplar Egg & Dart w/Lamb's Tongue 8 Ft. Crown Moulding

Actual Dimensions: $1\frac{3}{16}$ " x 5 $\frac{1}{2}$ ";
Installed Dimensions: 4 $\frac{3}{8}$ " x 3 $\frac{1}{2}$ "
[WR.CM83POP](#) **\$91.97**



Poplar Rope w/Dentil 8 Ft. Crown Moulding

Actual Dimensions: $\frac{3}{4}$ " x 5";
Installed Dimensions: 4" x 3"
[WR.CM87POP](#) **\$108.67**



Poplar Egg & Dart 8 Ft. Crown Moulding

Actual Dimensions: $\frac{3}{4}$ " x 2 $\frac{3}{4}$ ";
Installed Dimensions: 2 $\frac{1}{8}$ " x 1 $1\frac{1}{16}$ "
[WR.CM89POP](#) **\$65.06**

Corbels & Supports



14" Acanthus Corbel			
SKU	Size	Type	Each
WR.CRV5097LW	7 3/4" W x 14 1/2" H x 6" D	Lindenwood	\$214.23
WR.CRV5262MA	5 3/4" W x 14" H x 5 1/4" D	Maple	\$215.79

12" Acanthus Corbel			
SKU	Size	Type	Each
WR.CRV5098LW	5" W x 12" H x 4 1/2" D	Lindenwood	\$124.10

9 1/2" Acanthus Corbel			
SKU	Size	Type	Each
WR.CRV5266MA	5" W x 12" H x 4 1/2" D	Maple	\$131.35



15" Acanthus Corbel			
SKU	Size	Type	Each
WR.CRV5271CH	6 1/2" W x 15" H x 2 1/2" D	Cherry	\$213.91
WR.CRV5271MA	6 1/2" W x 15" H x 2 1/2" D	Maple	\$167.94

10 1/4" Acanthus Corbel			
SKU	Size	Type	Each
WR.CRV5272CH	4 5/8" W x 10 1/4" H x 1 3/4" D	Cherry	\$106.96
WR.CRV5272MA	4 5/8" W x 10 1/4" H x 1 3/4" D	Maple	\$86.31



14" Classic Corbel			
SKU	Size	Type	Each
WR.CRV5253LW	7" W x 14" H x 3 1/2" D	Lindenwood	\$149.90

11" Classic Corbel			
SKU	Size	Type	Each
WR.CRV5250LW	5" W x 11" H x 3" D	Lindenwood	\$109.79

12" Classic Corbel			
SKU	Size	Type	Each
WR.CRV5256LW	3 1/2" W x 12" H x 7 1/2" D	Lindenwood	\$141.43



14" Scrolled Corbel			
SKU	Size	Type	Each
WR.CRV5114LW	5 3/4" W x 14" H x 5" D	Lindenwood	\$202.61

12" Scrolled Corbel			
SKU	Size	Type	Each
WR.CRV5115LW	5" W x 12" H x 4" D	Lindenwood	\$163.01

12" Scrolled Corbel			
SKU	Size	Type	Each
WR.CRV5116LW	3 1/2" W x 12" H x 7 1/2" D	Lindenwood	\$203.17



12 3/8" Traditional Corbel			
SKU	Size	Type	Each
WR.CRV5105MA	4 1/4" W x 12 1/2" H x 4 1/2" D	Maple	\$136.98

9 3/4" Traditional Corbel			
SKU	Size	Type	Each
WR.CRV5109LW	4 1/2" W x 9 3/4" H x 4" D	Lindenwood	\$98.91

7" Traditional Corbel			
SKU	Size	Type	Each
WR.CRV5289MA	3 3/4" W x 7" H x 3 3/8" D	Maple	\$69.89

13" Traditional Corbel			
SKU	Size	Type	Each
WR.CRV5286MA	3 3/4" W x 13" H x 8 1/2" D	Maple	\$186.70



14" Mission Corbel			
SKU	Size	Type	Each
WR.CRV5102MA	5 3/4" W x 14" H x 5" D	Maple	\$214.85

12" Mission Corbel			
SKU	Size	Type	Each
WR.CRV5103MA	5" W x 12" H x 4" D	Maple	\$170.78

12" Mission Corbel			
SKU	Size	Type	Each
WR.CRV5104MA	5 1/2" W x 12" H x 7 1/2" D	Maple	\$186.70

Appliques & Medallions



Acanthus Center w/ Scrolls Only

SKU	Description	Size	Type	Each
WR.CRV5046LW	Extra Large	36" W x 7 1/2" H x 7/8" D	Lindenwood	\$180.31
WR.CRV5048LW	Large	24" W x 6" H x 3/4" D	Lindenwood	\$121.25
WR.CRV5049LW	Small	12" W x 4" H x 5/8" D	Lindenwood	\$57.84



Maple Acanthus Leaf Wooden Applique

SKU	Description	Size	Each
WR.CRV5576MA*	Small	3 1/2" W x 4 1/2" H x 3/4" D	\$70.12
WR.CRV5655MA	Medium	4" W x 7" H x 7/8" D	\$66.73
WR.CRV5653MA	Large	5" W x 9" H x 1" D	\$100.67

* Sold as Two per Package



Medium Corinthian Capital, Lindenwood

SKU	Size	Accepts up to	Size	Each
WR.CRV5131LW	Medium	5" x 3/4"	8" W x 8" H x 2 1/4" D	\$119.67
WR.CRV5134LW	Small	4 1/4" x 3/4"	6 7/8" W x 6 7/8" Hi x 2" D	\$90.99



Maple Ribbon Drop Applique

Sold as Two per Package

SKU	Size	Dimensions	Each
WR.CRV5641MA	Large	4" W x 16" H x 1/2" D	\$193.42
WR.CRV5637MA	Medium	3" W x 12" H x 1/2" D	\$126.67
WR.CRV5636MA	Small	2 1/4" W x 9" H x 1/2" D	\$117.63

Columns & Pilasters



Square Base, Lindenwood

SKU	Dimensions	Accepts up to	Each
WR.CRV5132LW	8" W x 5" H x 2 1/4" D	5" W x 3/4" D	\$63.34
WR.CRV5135LW	6 7/8" W x 4 1/4" H x 2" D	4 1/4" x 3/4" D	\$52.21



Extra Large Maple Fluted Pilaster

SKU	Size	Dimensions	Each
WR.MLD5825MA	XL, 5 Flutes	5" W x 3/4" D x 96" H	\$126.92
WR.MLD5827MA	LG, 3 Flutes	4 1/4" W x 3/4" D x 96" H	\$114.78



Hardware Resources®

More Hardware Resources Products are available online at www.cshardware.com/hardware-resources.html

Corbels & Supports



Mission Style Bar Bracket
3" W x 6" D x 14" H
Rubberwood
HR.CORH-RW \$50.63
Maple
HR.CORH-MP \$91.70
Alder
HR.CORH-ALD \$93.21
Cherry
HR.CORH-CH \$116.96
Oak
HR.CORH-OK \$81.50



Transitional Corbel
3" W x 10" D x 14" H
Rubberwood
HR.CORZ-1RW \$62.99
White Birch
HR.CORZ-1WB \$52.79
Maple
HR.CORZ-1MP \$142.45
Alder
HR.CORZ-1ALD \$121.10
Cherry
HR.CORZ-1CH \$154.96

Scrolled Bar Bracket

3 3/8" W x 7 3/4" D x 13" H
Rubberwood
HR.CORF-RW \$99.78
Maple
HR.CORF-MP \$163.68
Alder
HR.CORF-ALD \$196.71
Cherry
HR.CORF-CH \$262.76
Oak
HR.CORF-OK \$178.40



Traditional Smooth Bar Bracket Corbel

3" W x 6 1/2" D x 12" H
Rubberwood
HR.CORG-RW \$30.74
White Birch
HR.CORG-WB \$29.58
Maple
HR.CORG-MP \$54.51
Alder
HR.CORG-ALD \$54.07
Oak
HR.CORG-OK \$65.59
Cherry
HR.CORG-CH \$76.01



Traditional Simple Wood Bar Bracket
2" W x 7 1/2" D x 10 1/2" H
Rubberwood
HR.CORM-RW \$16.70
White Birch
HR.CORM-WWB \$18.72
Maple
HR.CORM-MP \$38.23
Alder
HR.CORM-ALD \$36.80



Traditional Simple Wood Bar Bracket
3" W x 7 3/8" D x 10 1/2" H
Rubberwood
HR.CORM-3RW \$25.86
White Birch
HR.CORM-3WB \$28.93
Maple
HR.CORM-3MP \$31.60
Alder
HR.CORM-3ALD \$38.07



Small Acanthus Wood Corbel
4 1/2" W x 5" D x 10" H
Rubberwood
HR.CORBB-1RW \$82.85
Alder
HR.CORBB-1ALD \$169.77
Cherry
HR.CORBB-1CH \$241.62
Maple
HR.CORBB-1MP \$141.50



Small Traditional Wood Corbel
4 1/2" W x 5" D x 10" H
Rubberwood
HR.CORC-1RW \$74.37
Alder
HR.CORC-1ALD \$140.64
Cherry
HR.CORC-1CH \$201.12
Maple
HR.CORC-1MP \$134.05



Traditional Wood Bar Bracket
2 1/2" W x 8" D x 8" H
Rubberwood
HR.CORB-1RW \$17.90
White Birch
HR.CORB-1WB \$14.39
Cherry
HR.CORB-1CH \$46.05

Wooden Furniture Feet



Shaker Style Bun Foot
Rubberwood,
3 1/2" H x 4 1/2" W
HR.BF33RW \$23.32



Square Transitional Bun Foot
4 1/4" H x 4 1/4" D x 4 1/4" W
Rubberwood
HR.BF90RW \$23.43
Maple
HR.BF90MP \$43.91



Reversible Turned Bun Foot
Rubberwood,
4" H x 4 3/4" D x 4 3/4" W
HR.BF70RW \$19.35



Turned Bun Foot
Rubberwood,
6" H x 4" D x 4" W
HR.BF60RW \$19.35



Mission Style Bun Foot
Rubberwood,
4 1/2" H x 4 1/2" D x 4 1/2" W
HR.BF40RW \$25.35



Triangular Mission Bun Foot
Rubberwood,
4 1/2" H x 3 1/2" D x 3 1/2" W
HR.BF35RW \$23.49



Shaker Style Tapered Bun Foot
Rubberwood,
4" H x 2 1/4" D x 2 1/4" W
HR.BF34RW \$6.23



Smooth Transitional Bun Foot
Rubberwood,
3" H x 5" D x 5" W
HR.BF30RW \$10.75



Greek Style Bun Foot
Rubberwood,
4 1/2" H x 3 1/2" D x 3 1/2" W
HR.BF41RW \$26.43



Turned Bun Foot (Furniture or Cabinet Leg)
Rubberwood,
4" H x 4" D x 4" W
HR.BF4-RW \$23.84



Turned Bun Foot (Furniture or Cabinet Leg)
Rubberwood,
4 1/2" H x 4 1/2" D x 4 1/2" W
HR.BF45RW \$18.74

Island Legs & Turnings



Acanthus Corner Post - 2 3/4"



Fluted Corner Modern Post - 5"

Acanthus Corner Post, 35 1/2" Height

SKU	Type	Each
2 3/4" Square Width		
HR.CP-1RW	Rubberwood	\$60.17
HR.CP-1MP	Maple	\$139.01
HR.CP-1ALD	Alder	\$137.75
HR.CP-1CH	Cherry	\$182.93

Fluted Corner Modern Post, 35 1/2" Height

SKU	Type	Each
5" Square Width		
HR.P38RW	Rubberwood	\$257.69
HR.P38MP	Maple	\$463.95
HR.P38ALD	Alder	\$405.04



Turned Wood Post - 3 1/2" **Square Mission Post - 3 1/2"** **Square Modern Post - 5"** **Post w/Reed Pattern - 3 1/2"** **Post w/Rope Pattern - 3 1/2"**

Turned Wood Post, 35 1/2" Height

SKU	Type	Each
3 1/2" Square Width		
HR.P1RW	Rubberwood	\$75.38
5" Square Width		
HR.P1-5-36RW	Rubberwood	\$196.09
HR.P1-5-36MP	Maple	\$403.92
HR.P1-5-36ALD	Alder	\$350.82
HR.P1-5-36CH	Cherry	\$448.27
HR.P1-5-36WB	White Birch	\$287.05

Square Mission Post, 35 1/2" Height

SKU	Type	Each
3" Square Width		
HR.P5-9-3RW	Rubberwood	\$97.23
HR.P5-9-3CH	Cherry	\$229.09
HR.P5-9-3MP	Maple	\$196.82
3 3/4" Square Width		
HR.P5-9RW	Rubberwood	\$114.34
5" Square Width		
HR.P5-9-5-RW	Rubberwood	\$359.07
HR.P5-9-5-HMP	Maple	\$434.98
HR.P5-9-5-ALD	Alder	\$379.55
HR.P5-9-5-CH	Cherry	\$496.86
HR.P5-9-5-WB	White Birch	\$315.58

Square Modern Post, 35 1/2" Height

SKU	Type	Each
3 1/2" Square Width		
HR.P35-3-5-RW	Rubberwood	\$140.53
HR.P35-3-5-HMP	Maple	\$173.30
HR.P35-3-5-WB	White Birch	\$144.71
5" Square Width		
HR.P35RW	Rubberwood	\$241.31
HR.P35MP	Maple	\$439.25
HR.P35ALD	Alder	\$390.28

6" Square Width		
HR.P35-6-RW	Rubberwood	\$353.45
HR.P35-6-HMP	Maple	\$507.94
HR.P35-6-ALD	Alder	\$475.69
HR.P35-6-WB	White Birch	\$363.86
HR.P35-6-CH	Cherry	\$546.89

Post w/Reed Pattern, 35 1/2" Height

SKU	Type	Each
3" Square Width		
HR.P2-3RW	Rubberwood	\$75.54
HR.P2-3MP	Maple	\$177.31
HR.P2-3ALD	Alder	\$136.33
3 1/2" Square Width		
HR.P2RW	Rubberwood	\$75.38
HR.P2MP	Maple	\$185.50
HR.P2WB	White Birch	\$101.93
HR.P2CH	Cherry	\$269.91
HR.P2OK	Oak	\$157.37

Post w/Rope Pattern, 35 1/2" Height

SKU	Type	Each
3" Square Width		
HR.P3-3RW	Rubberwood	\$86.09
HR.P3-3MP	Maple	\$165.95
HR.P3-3ALD	Alder	\$136.33
HR.P3-3CH	Cherry	\$211.74
3 1/2" Square Width		
HR.P3RW	Rubberwood	\$75.74
HR.P3MP	Maple	\$188.93
HR.P3WB	White Birch	\$100.91
HR.P3CH	Cherry	\$275.72
HR.P3OK	Oak	\$162.68

Arborescence®

Island Legs & Turnings



Ask about the other styles and species that we have available!

Whole Legs, 3 1/2" Square x 35 1/2" H

SKU	Type	Each
Colonial		
BW.01IM5100AK1	Red Oak	\$104.75
BW.01510200AL1	Alder	\$189.10
BW.01IM5100CH1	Cherry	\$100.72
Fluted		
BW.01IM5101AK1	Red Oak	\$100.84
BW.01IM5101AL1	Alder	\$113.45
BW.01IM5101CH1	Cherry	\$108.15
BW.01IM5101HM1	Maple	\$99.73
Gun Barrel		
BW.01IM5102AK1	Red Oak	\$101.80
BW.01IM5102AL1	Alder	\$94.35
BW.01IM5102CH1	Cherry	\$100.72
BW.01IM5102HM1	Maple	\$129.25
Rope		
BW.01IM5103AK1	Red Oak	\$101.80
BW.01IM5103AL1	Alder	\$111.82
BW.01IM5103CH1	Cherry	\$109.61
BW.01IM5103HM1	Maple	\$101.25
Mission, 3" Square x 35 1/2"		
BW.01IM5104AL1	Alder	\$112.00
BW.01IM5104CH1	Cherry	\$93.82
BW.01IM5104WK1	White Oak	\$90.84

Half Legs, 1 1/16" D x 3 1/2" W x 35 1/2" H

SKU	Type	Each
Colonial		
BW.01IM5100AL2	Alder	\$55.93
BW.01510200AL2	Cherry	\$79.79
BW.01IM5100HM2	Maple	\$49.01
Fluted		
BW.01IM5101AK2	Red Oak	\$54.53
BW.01IM5101AL2	Alder	\$60.85
BW.01IM5101CH2	Cherry	\$58.19
BW.01IM5101HM2	Maple	\$59.75
Gun Barrel		
BW.01IM5102AK2	Red Oak	\$47.73
BW.01IM5102AL2	Alder	\$51.29
BW.01IM5102CH2	Cherry	\$54.49
BW.01IM5102HM2	Maple	\$58.90
Rope		
BW.01IM5103AL2	Alder	\$60.02
BW.01IM5103CH2	Cherry	\$58.92
BW.01IM5103HM2	Maple	\$83.09
Mission, 3" Square x 35 1/2"		
BW.01IM5104AL2	Alder	\$60.12
BW.01IM5104CH2	Cherry	\$51.03
BW.01IM5104HM2	Maple	\$47.73
BW.01IM5104WK2	White Oak	\$49.55



Edgebanding & Veneer

Veneer Sheets

Give your wood a decorative and elegant look with the help of our veneer sheets. Custom Service Hardware offers a variety of veneer sheets that you can use on plywood, paneling, furniture and more. Choose from a variety of wood types, grain types and styles to get the perfect look for your home.

Grain Patterns



Flat Cut



Quarter Cut



Rift Cut



Rotary Cut

Cathedral Pattern Narrow Striped Pattern Narrow Striped Pattern Very Broad Pattern

- Available 10 mil, 20 mil, and 30 mil paper backers or Allwood wood backer
- Paper-backed veneer contains **no** added urea formaldehyde
- Prices may vary due to market fluctuation

Veneer with 10 Mil Backer

SKU	Size	Price
White Ash, Flat Cut		
EM.ASFC.10M.2.8	2' x 8'	\$33.54
EM.ASFC.10MPSA.2.8	2' x 8' PSA	\$79.32
EM.ASFC.10M.4.8	4' x 8'	\$72.77
EM.ASFC.10MPSA.2.8	4' x 8' PSA	\$79.32
Cherry, Flat Cut		
EM.CHFC.10M.2.8	2' x 8'	\$43.68
EM.CHFC.10MPSA.2.8	2' x 8' PSA	\$68.84
EM.CHFC.10M.4.8	4' x 8'	\$67.09
EM.CHFC.10MPSA.2.8	4' x 8' PSA	\$68.84
Hickory, Flat Cut		
EM.HCFC.10M.2.8	2' x 8'	\$33.55
EM.HCFC.10MPSA.2.8	2' x 8' PSA	\$102.38
EM.HCFC.10M.4.8	4' x 8'	\$67.09
EM.HCFC.10MPSA.2.8	4' x 8' PSA	\$102.38
Maple, Flat Cut		
EM.MAFC.10M.2.8	2' x 8'	\$67.83
EM.MAFC.10MPSA.2.8	2' x 8' PSA	\$80.72
EM.MAFC.10M.4.8	4' x 8'	\$63.60
EM.MAFC.10MPSA.2.8	4' x 8' PSA	\$80.72
Red Oak, Flat Cut		
EM.ROFC.10M.2.8	2' x 8'	\$32.37
EM.ROFC.10MPSA.2.8	2' x 8' PSA	\$91.20
EM.ROFC.10M.4.8	4' x 8'	\$64.99
EM.ROFC.10MPSA.2.8	4' x 8' PSA	\$91.20
Walnut, Flat Cut		
EM.WAFC.10M.2.8	2' x 8'	\$39.14
EM.WAFC.10MPSA.2.8	2' x 8' PSA	\$109.02
EM.WAFC.10M.4.8	4' x 8'	\$100.64
EM.WAFC.10MPSA.2.8	4' x 8' PSA	\$109.02
White Birch, Flat Cut		
EM.WBFC.10M.2.8	2' x 8'	\$43.68
EM.WBFC.10MPSA.2.8	2' x 8' PSA	\$87.53
EM.WBFC.10M.4.8	4' x 8'	\$93.65
EM.WBFC.10MPSA.2.8	4' x 8' PSA	\$87.53
White Oak, Quarter Cut		
EM.WOQC.10M.2.8	2' x 8'	\$42.28
EM.WOQC.10MPSA.2.8	2' x 8' PSA	\$88.06
EM.WOQC.10M.4.8	4' x 8'	\$84.56
EM.WOQC.10MPSA.2.8	4' x 8' PSA	\$88.06

Allwood, Veneer with Wood Backer

SKU	Size	Price
White Ash, Flat Cut		
EM.ASFC.AW.2.8	2' x 8'	\$68.84
EM.ASFC.AWPSA.2.8	2' x 8' PSA	\$73.73
EM.ASFC.AW.4.8	4' x 8'	\$91.55
EM.ASFC.AWPSA.4.8	4' x 8' PSA	\$147.46
Cherry, Flat Cut		
EM.CHFC.AW.2.8	2' x 8'	\$45.78
EM.CHFC.AWPSA.2.8	2' x 8' PSA	\$91.55
EM.CHFC.AW.4.8	4' x 8'	\$91.55
EM.CHFC.AWPSA.4.8	4' x 8' PSA	\$147.46
Hickory, Flat Cut		
EM.HCFC.AW.2.8	2' x 8'	\$46.13
EM.HCFC.AWPSA.2.8	2' x 8' PSA	\$91.55
EM.HCFC.AW.4.8	4' x 8'	\$92.25
EM.HCFC.AWPSA.4.8	4' x 8' PSA	\$162.14
Maple, Flat Cut		
EM.MAFC.AW.2.8	2' x 8'	\$56.76
EM.MAFC.AWPSA.2.8	2' x 8' PSA	\$87.36
EM.MAFC.AW.4.8	4' x 8'	\$81.07
EM.MAFC.AWPSA.4.8	4' x 8' PSA	\$185.64
Red Oak, Flat Cut		
EM.ROFC.AW.2.8	2' x 8'	\$37.04
EM.ROFC.AWPSA.2.8	2' x 8' PSA	\$82.82
EM.ROFC.AW.4.8	4' x 8'	\$80.37
EM.ROFC.AWPSA.4.8	4' x 8' PSA	\$178.21
Walnut, Flat Cut		
EM.WAFC.AW.2.8	2' x 8'	\$51.37
EM.WAFC.AWPSA.2.8	2' x 8' PSA	\$96.80
EM.WAFC.AW.4.8	4' x 8'	\$102.04
EM.WAFC.AWPSA.4.8	4' x 8' PSA	\$185.64
White Birch, Flat Cut		
EM.WBFC.AW.2.8	2' x 8'	\$55.91
EM.WBFC.AWPSA.2.8	2' x 8' PSA	\$71.98
EM.WBFC.AW.4.8	4' x 8'	\$88.06
EM.WBFC.AWPSA.4.8	4' x 8' PSA	\$143.97
White Oak, Quarter Cut		
EM.WOQC.AW.2.8	2' x 8'	\$54.86
EM.WOQC.AW.4.8	4' x 8'	\$109.02
EM.WOQC.AWPSA.4.8	4' x 8' PSA	\$200.64

Edgebanding

Custom Service Hardware offers edgebanding and veneer edging in various sizes and finishes to match your woodworking projects. Whether you're looking to cover the exposed sides of materials or take on the task of making your own furniture, our wood edging products will help you along the way.

1 3/16" Pre-Glued Edgebanding, 250 ft. Roll

SKU	Type	Price
EM..8125.250.AD	Alder	\$40.95
EM..8125.250.AN	Anigre	\$31.12
EM..8125.250.AS	Ash	\$34.40
EM..8125.250.CH*	Cherry	\$40.40
EM..8125.250.CB	Car. Dark Bamb.	\$54.60
EM..8125.250.HC	Hickory	\$40.95
EM..8125.250.MA*	Maple	\$34.23
EM..8125.250.MAF	Mahogany Afr.	\$31.12
EM..8125.250.NB	Natural Birch	\$54.60
VS..8125.250.PO	Poplar	\$27.78
EM..8125.250.RB	Red Birch	\$38.22
EM..8125.250.RO*	Red Oak	\$31.12
EM..8125.250.SA	Sapele	\$36.58
EM..8125.250.TK	Teak	\$38.22
EM..8125.250.WA	Walnut	\$45.86
EM..8125.250.WB*	White Birch	\$34.23
EM..8125.250.WO	White Oak	\$45.86
EM..8125.250.WP	White Pine	\$38.22

Melamine		
EM..8125.250.MBL	Black	\$28.39
EM..8125.250.NB	Nat. Dark Bamb.	\$54.60
EM..8125.250.MHM	Hardrock Maple	\$86.81
EM..8125.250.MWH*	White	\$55.15

*In Stock at our Warehouse

7/8" Non-Glued Edgebanding, 500 ft. Roll

SKU	Type	Price
EM..8750.500.CH	Cherry	\$76.00
EM..8750.500.MA	Maple	\$54.60
EM..8750.500.RO	Red Oak	\$76.00
EM..8750.500.WB	White Birch	\$76.00
EM..8750.500.WO	White Oak	\$65.52

3mm x 7/8" Thick Edge, 328 ft. Roll

SKU	Type	Price
EM..8750.3.328.CH	Cherry	\$254.46
EM..8750.3.328.MA	Maple	\$218.33
EM..8750.3.328.RO	Red Oak	\$218.33



FC.QPROTRIM

FC.QTRIM

FC.QPROTRIM	Quad Pro Trimmer	\$53.24
FC.QPROBLADE	Q. Pro Trimmer Blades	\$34.61
FC.QTRIM	Quad Trimmer	\$26.62
FC.QBLADE	Quad Trimmer Blades	\$13.31

Lamello Hot Air Edgeband Set

Portable and easy to use. Hot air allows you to apply all types of pre-glued tapes over curved shapes up to two inches wide. Includes end trimmer (LRC-21E) and edge trimmer (FE.TR).



LAG52F 110 V. Edgebander \$565.00

Virutex End Trimmer

This manual end trimmer makes a perfect,



clean and high quality cut on all board corners. No other finishing operations are needed. Equipped with double-sided blades.

LRC-21E End Trimmer \$55.00

LRC21E-B Extra Blades \$19.99

Flush Cut Trimmers, Heavy-Duty

Includes: (2) Power Mags for cutting nails flush.



Not recommended for hardened nails or screws.

FC.PLIERSHDFC Flush Cut Trimmers \$26.60

SpeedRollerPro

Ergonomic laminate roller with interchangeable rollers.



Includes: (2) non-marring rubber wheels & (2) maximum psi steel wheels

FC.SPEEDROLLERPRO SpeedRollerPRO \$39.93

Double Edge Trimmer

Squeeze the tool to trim edge flush with board



faces 3/16" to 1 1/4" thick. It can be used as two trimmers for wider stock.

FE.TR Double Edge Trimmer \$26.40

FE.BL Extra Blades (2-Pair) \$16.50



FastCap SKU Example Shown:



Single Sheet, (52) 9/16" Caps

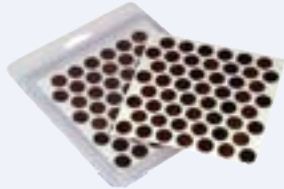

Mini Box- Five Sheets, (260) 9/16" Caps



Standard Box- 20 Sheets, (1,040) 9/16" Caps



Bulk Box- 500 Sheets, (26,000) 9/16" Caps



Description	Single Sheet	Mini Box	Standard Box
PVC Solid	\$2.56	\$9.65	\$27.90
PVC Woodgrain	\$2.55	\$10.34	\$34.89
Unfinished	\$5.08	\$13.86	\$50.31
Finished Wood	\$5.08	\$16.92	\$61.40

Ordering FastCaps

- | Product Type | Code |
|--------------|------|
| FastCap | FC |
- | Material Type | Code |
|------------------|------|
| Single Sheet | 1SH |
| Mini Box | MB |
| Standard Box: | |
| Solid PVC | SP |
| Woodgrain PVC | WP |
| Solid Real Wood | SW |
| Prefinished Wood | PW |
| Metallic | ME |

For Bulk Box, Please call for SKU

- | Descrip. | Cap Type | Code |
|---|----------------------------------|--|
| Round | 3/8" (9mm) | 38 |
| | 7/16" | 716 |
| | 1/2" (13mm) | 12 |
| | 9/16" (14mm) | 916 |
| | 5/8" | 58 |
| | 1 1/16" (18mm) | 1116 |
| | 1" (25mm) | 1 |
| | 1 1/4" | 114 |
| | 1 3/8" (42mm) | 158 |
| | 2 1/4" (57mm) | 214 |
| | 3" (76mm) | 3 |
| | 3 1/2" | 312 |
| | Plumbing | 1/2" Supply Lines & 1 1/2" Waste Lines |
| 1/2" Supply Lines | | P2 |
| 1/2" Supply Lines & 2 1/16" Waste Lines | | P3 |
| 1/2" Supply Lines & 2 1/4" Waste Lines | | P4 |
| 5 x 5 Patch | | P5 |
| Electrical | Electrical Box Trim | E1 |
| | Double Gang Box (White Only) | E2 |
| Cabinetry | Kreg Tool Cap | KC |
| | Castle Cap | CC |
| CC | Par Cap (4") | PAR4 |
| | Par Cap (5 1/2") | PAR5 |
| PAR4 | Hinge Cover Cap | H2.5 |
| | Knockdown Cap | KD |
| PAR5 | Rafix 1 | RAF1X1 |
| | Rafix 2 | RAF1X2 |
| KD | RTA 1 | RTA1 |
| | RTA 2 | RTA2 |
| Misc. | Phone Pads | PP |
| | Fastpad Screw Cap (Smooth White) | FP |



Description	50' L	250' L	600' L
PVC Solid	22.88	\$114.36	\$148.20
Woodgrain PVC	25.41	\$114.36	\$228.64
Unfinished Wood	38.13	\$177.87	
Finished Wood	44.43	\$209.64	

Pricing for widths 3/4" & 1 5/16" only. Other widths are available, call for pricing.

Fastedge SKU Example Shown:



Ordering Fastedge

- | Product Type | Code |
|--------------|------|
| Fastedge | FE |
- | Material Type | Code |
|------------------|------|
| Solid PVC | SP |
| Woodgrain PVC | WP |
| Solid Real Wood | SW |
| Prefinished Wood | PW |
| Metallic | ME |
- | Width & Length Type | Code |
|---------------------|------|
| Width Type | |
| 3/4" Width | 34 |
| 1 5/16" Width | 1516 |
| Length Type | |
| 25' Length | 25 |
| 50' Length | 50 |
| 250' Length | 250 |
| 600' Length | 600 |

4. Fastcaps and Fastedge are offered in (70) stock colors (PVC & Real Wood). Custom colors are also available, minimum order is a standard box. **The Abbreviations in bold (under the color) are the Final Product Color Code.**

PVC (Solids & Woodgrains)



Prefinished (Real Wood)



Unfinished (Real Wood)



We can match most laminates in Fastcap and Fastedge. In most cases we can do it in just a few days! Call to check for available colors.

Abrasives

Abrasives

Custom Service Hardware offers a variety of abrasive products in a variety of sizes, shapes and grits such as abrasive blocks, sandpaper, sanding belts and discs.

Sandpaper and Sanding Blocks



SKU	Grit	Price per Sleeve		Case Qty	Case
		Sleeve	Case		
A-Weight Paper - Silicon Carbide, Stearated					
85.9.11.120.SCA	120	\$46.71	10		\$43.20
85.9.11.150.SCA	150	\$46.71	10		\$43.20
85.9.11.180.SCA	180	\$46.71	10		\$43.20
85.9.11.220.SCA	220	\$46.71	10		\$43.20
85.9.11.320.SCA	320	\$46.71	10		\$43.20



C-Weight Paper - Aluminum Oxide					
85.9.11.080.AOC*	80	\$21.63	10		\$20.00
85.9.11.100.AOC	100	\$39.79	10		\$36.80
85.9.11.120.AOC	120	\$39.79	10		\$36.80
85.9.11.150.AOC	150	\$39.79	10		\$36.80
85.9.11.180.AOC	180	\$39.79	10		\$36.80
85.9.11.220.AOC	220	\$39.79	10		\$36.80

100 Sheets per Sleeve

*50 Sheets per Sleeve

- 9" x 11" Paper Sheets
- Open Coat
- Stearated
- Equivalent to 3M Tri-M-ite Fre-Cut
- Other Sizes and Grits Available
- 100 Sheets per Sleeve

Sunrite® 6" x 9" Cleaning and Finishing Pads

Applications

White: Non-Abrasive; Applying Waxes & Polishes; Super Polish

Gray: Silicon Carbide; Light Duty; Cleaning & Finishing; Defuzzing Stain Coat

Maroon: Aluminum Oxide; General Cleaning & Finishing; Metal Finish; Remove Rust; Scuffing; Raw Wood Preparation; Wipe After Sealer Coat

Green: Aluminum Oxide; Abrasive Grain; Heavy Duty; Cleaning & Finishing

Black: Silicon Carbide; More Abrasive Grain; Heavy Duty; Cleaning & Finishing

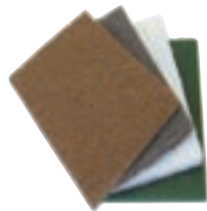

- Tough Abrasive Pads
- Wet or Dry Sanding
- Flexible & Reusable

SKU	Color	Grit	Material	Use	Grit*	Case Qty	Price per Each	
							Each	Case
85.6.9.050	Black		Silicon Carbide	Med	150-180	60	\$2.46	\$2.2364
85.6.9.020	Green		Alum-Oxide	Gen-Purpose	240-280	60	\$0.87	\$0.80
85.6.9.005	Maroon		Alum-Oxide	Fine	280-320	60	\$0.87	\$0.80
85.6.9.010	Gray		Alum-Oxide	Ultra Fine	800-1000	60	\$1.00	\$0.93
85.6.9.015	White		N/A	Not Abrasive	N/A	60	\$1.04	\$0.96

*Hand pads do not cut, but the equivalent finish that would be achieved can be compared to sandpaper.



Dusting/Tack Cloths

Guardsman Reusable Dusting Cloths are specially treated and lint-free to grab and trap dust to remove allergens for healthier, cleaner air without the use of sprays!

VC.462100	Single Pack	\$3.19
VC.462500	12 Pack	\$19.99

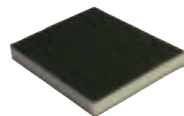

Sanding Pads - Flexible, 2-Sided

Aluminum Oxide, 250 per Case
Size: 4 3/4" x 3 7/8" x 1/2" thick

SKU	Sanding Pad	Price per Each	
		Each	Case
870.0002.100	100, Medium	\$0.80	\$0.75
870.0002.150	150, Med Fine	\$0.80	\$0.75
870.0002.180	180, Fine	\$0.80	\$0.75
870.0002.220	220, Extra Fine	\$0.80	\$0.75

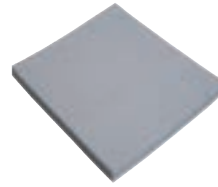

Sanding Pads - High Flex, 1-Sided

Aluminum Oxide, 100 per Case
Size: 5 1/2" x 4 1/2" x 3/16" thick

SKU	Sanding Block	Price per Each	
		Each	Case
870.0001.100	100, Medium	\$1.09	\$0.89
870.0001.220	220, Extra Fine	\$1.09	\$0.89

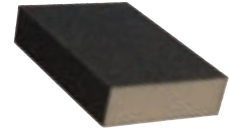

Sanding Blocks - Flexible, 4-Sided

Aluminum Oxide, 250 per Case
Size: 3 7/8" x 2 5/8" x 1" thick

SKU	Sanding Block	Price per Each	
		Each	Case
870.0004.060	60, Coarse	\$0.86	\$0.81
870.0004.080	80, Med Coarse	\$0.86	\$0.81
870.0004.100	100, Medium	\$0.86	\$0.81
870.0004.150	150, Med Fine	\$0.86	\$0.81
870.0004.180	180, Fine	\$0.90	\$0.85
870.0004.220	220, Extra Fine	\$0.86	\$0.81

Sanding Belts and Rolls



Wide Belts

- Open Coat
- Cloth Backing
- Other Sizes and Grits Available

36 x 60 Alum-Oxide "X" Weight

SKU	Grit	Case Qty	Case
87.36.060.060	60	5	\$190.80
87.36.060.080	80	5	\$178.44

36 x 75 Alum-Oxide "X" Weight

SKU	Grit	Case Qty	Case
87.36.060.120	120	5	\$236.39
87.36.060.150	150	5	\$236.39
87.36.060.180	180	5	\$170.34
87.36.060.220	220	5	\$170.34

36 x 75 Alum-Oxide "X" Weight

SKU	Grit	Case Qty	Case
87.36.075.060	60	5	\$253.07
87.36.075.080	80	5	\$236.60
87.36.075.100	100	5	\$225.95
87.36.075.120	120	5	\$225.95
87.36.075.150	150	5	\$225.95
87.36.075.180	180	5	\$225.95
87.36.075.220	220	5	\$225.95

37 x 60 Alum-Oxide "X" Weight

SKU	Grit	Case Qty	Case
87.37.060.060	60	5	\$115.18
87.37.060.080	80	5	\$178.44
87.37.060.100	100	5	\$175.89
87.37.060.120	120	5	\$175.89
87.37.060.150	150	5	\$175.89
87.37.060.180	180	5	\$175.89
87.37.060.220	220	5	\$175.89

37 x 75 Alum-Oxide "X" Weight

SKU	Grit	Case Qty	Case
87.37.075.060	60	5	\$238.73
87.37.075.080	80	5	\$223.28
87.37.075.100	100	5	\$213.18
87.37.075.120	120	5	\$213.18
87.37.075.150	150	5	\$213.18
87.37.075.180	180	5	\$213.18
87.37.075.220	220	5	\$213.18

PSA Abrasive Rolls

4 1/2" x 10 Yard Rolls

SKU	Grit	Price per Roll		
		Roll	Case Qty	Case
86.22-45080.SCA	80	\$18.70	10	\$16.80
86.22-45100.SCA	100	\$16.61	10	\$15.36
86.22-45120.SCA	120	\$16.61	10	\$15.36
86.22-45150.SCA	150	\$16.61	10	\$15.36
86.22-45180.SCA	180	\$16.61	10	\$15.36
86.22-45220.SCA	220	\$16.61	10	\$15.36
86.22-45320.SCA	320	\$16.44	10	\$15.20



- Resin Bond
- Open Coat

Abrasives

Quality Abrasives Aluminum Oxide Cloth

Other Sizes/Grits Available Upon Request



3 x 18 Alum-Oxide "X" Weight

SKU	Grit	Price per Box	
		Box	Case
87.03.018.060	60	\$17.65	\$16.32

10 Belts per Box; 50 Boxes per Case

3 x 21 Alum-Oxide "X" Weight

SKU	Grit	Price per Box	
		Box	Case
87.03.021.040	40	\$14.71	\$13.60
87.03.021.050	50	\$16.24	\$13.84
87.03.021.060	60	\$13.67	\$12.64
87.03.021.080	80	\$13.15	\$12.16
87.03.021.100	100	\$12.98	\$12.00
87.03.021.120	120	\$12.98	\$12.00
87.03.021.150	150	\$13.67	\$12.64
87.03.021.180	180	\$13.67	\$12.64
87.03.021.220	220	\$13.67	\$12.64

10 Belts per Box; 50 Boxes per Case

3 x 24 Alum-Oxide "X" Weight

SKU	Grit	Price per Box	
		Box	Case
87.03.024.040	40	\$15.74	\$14.56
87.03.024.050	50	\$15.36	\$14.21
87.03.024.060	60	\$14.71	\$13.60
87.03.024.080	80	\$14.01	\$12.96
87.03.024.100	100	\$13.67	\$12.64
87.03.024.120	120	\$13.67	\$12.64
87.03.024.150	150	\$14.36	\$13.28
87.03.024.180	180	\$14.36	\$13.28
87.03.024.220	220	\$14.36	\$13.28

10 Belts per Box; 50 Boxes per Case

4 x 24 Alum-Oxide "X" Weight

SKU	Grit	Price per Box	
		Box	Case
87.04.024.036	36	\$15.83*	\$14.64*
87.04.024.050	50	\$21.45	\$19.84
87.04.024.060	60	\$20.41	\$18.88
87.04.024.080	80	\$19.90	\$18.40
87.04.024.100	100	\$19.38	\$17.92
87.04.024.120	120	\$19.38	\$17.92
87.04.024.150	150	\$20.59	\$19.04
87.04.024.180	180	\$20.59	\$19.04
87.04.024.220	220	\$20.59	\$19.04

10 Belts per Box; 50 Boxes per Case

*5 Belts per Box; 25 Boxes per Case

Aluminum Oxide Cloth

Other Sizes and Grits Available

4 x 132 Alum-Oxide "X" Weight

SKU	Grit	Price per Each	
		Each	Case
87.04.132.060	60	\$8.65	\$8.00
87.04.132.080	80	\$8.39	\$7.76
87.04.132.100	100	\$8.13	\$7.52
87.04.132.120	120	\$8.13	\$7.52
87.04.132.220	220	\$9.24	\$8.55

10 Belts per Case

6 x 48 Alum-Oxide "X" Weight

SKU	Grit	Price per Each	
		Each	Case
87.06.048.060	60	\$4.93	\$4.56
87.06.048.080	80	\$4.67	\$4.32
87.06.048.100	100	\$4.50	\$4.16
87.06.048.120	120	\$4.50	\$4.13
87.06.048.150	150	\$4.50	\$4.16
87.06.048.220	220	\$4.50	\$4.16

10 Belts per Case

6 x 80 Alum-Oxide "X" Weight

SKU	Grit	Price per Each	
		Each	Case
87.06.080.080	80	\$7.96	\$7.36
87.06.080.100	100	\$7.70	\$7.12
87.06.080.120	120	\$7.70	\$7.12

10 Belts per Case

6 x 89 Alum-Oxide "X" Weight

SKU	Grit	Price per Each	
		Each	Case
87.06.089.060	60	\$8.91	\$8.24
87.06.089.080	80	\$8.56	\$7.92
87.06.089.100	100	\$8.22	\$7.60
87.06.089.150	150	\$8.22	\$7.60

10 Belts per Case

6 x 108 Alum-Oxide "X" Weight

SKU	Grit	Price per Each	
		Each	Case
87.06.108.080	80	\$12.44	\$11.40
87.06.108.100	100	\$11.38	\$10.53
87.06.108.120	120	\$11.38	\$10.53

10 Belts per Case

Sanding Discs



5" C-Weight, Gold

PSA Disc on Roll

SKU	Grit	Price per Roll	
		Roll	Case
P6.23-05100.DOR	100	\$31.73	\$29.45
P6.23-05120.DOR	120	\$31.73	\$29.45
P6.23-05150.DOR	150	\$32.57	\$30.23
P6.23-05180.DOR	180	\$31.73	\$29.45
P6.23-05220.DOR	220	\$31.73	\$29.45

100 Discs per Roll; 8 Rolls per Case

PSA Disc with Tabs

SKU	Grit	Price per Box	
		Box	Case
P6.23-05060.DWT*	60	\$22.55	\$20.90
P6.23-05080.DWT	80	\$34.24	\$31.78
P6.23-05100.DWT	100	\$31.73	\$29.45
P6.23-05120.DWT	120	\$31.73	\$29.45
P6.23-05150.DWT	150	\$34.24	\$31.78
P6.23-05180.DWT	180	\$31.73	\$29.45
P6.23-05220.DWT	220	\$32.57	\$30.23
P6.23-05320.DWT	320	\$30.73	\$28.52

100 Discs per Box; 8 Boxes per Case

*50 p/ Box

5-Hole PSA Disc with Tabs

SKU	Grit	Price per Box	
		Box	Case
P6.23-050605DWT*	60	\$18.52	\$17.19
P6.23-050805DWT	80	\$33.40	\$31.00
P6.23-051005DWT	100	\$30.73	\$28.52
P6.23-051205DWT	120	\$31.73	\$29.45
P6.23-051805DWT	180	\$28.39	\$26.35
P6.23-052205DWT	220	\$27.56	\$25.58
P6.23-053205DWT	320	\$28.39	\$26.35

100 Discs per Box; 8 Boxes per Case

*50 p/ Box

5-Hole Velcro Hook and Loop

SKU	Grit	Price per Box	
		Box	Case
P6.23-05080V5	80	\$34.24	\$31.78
P6.23-05100V5	100	\$32.57	\$30.23
P6.23-05120V5	120	\$34.24	\$31.78
P6.23-05150V5	150	\$34.24	\$31.78
P6.23-05180V5	180	\$33.40	\$31.00
P6.23-05220V5	220	\$34.24	\$31.78
P6.23-05320V5	320	\$43.49	\$40.39

100 Discs per Box; 8 Boxes per Case

8-Hole PSA Disc with Tabs

SKU	Grit	Price per Box	
		Box	Case
P6.23-050608DWT*	60	\$20.88	\$19.38
P6.23-050808DWT	80	\$35.07	\$32.55
P6.23-051008DWT	100	\$32.57	\$30.23
P6.23-051208DWT	120	\$35.07	\$32.55
P6.23-051508DWT	150	\$32.57	\$30.23
P6.23-051808DWT	180	\$28.39	\$26.35
P6.23-052208DWT	220	\$27.56	\$25.58

100 Discs per Box; 8 Boxes per Case

*50 p/ Box

8-Hole Velcro Hook and Loop

SKU	Grit	Price per Box	
		Box	Case
P6.23-05060V8*	60	\$22.21	\$20.62
P6.23-05080V8	80	\$33.40	\$31.00
P6.23-05100V8	100	\$33.40	\$31.00
P6.23-05120V8	120	\$30.40	\$31.00
P6.23-05150V8	150	\$30.40	\$31.00
P6.23-05180V8	180	\$32.40	\$31.00
P6.23-05220V8	220	\$33.40	\$31.00
P6.23-05320V8	320	\$34.24	\$31.78

100 Discs per Box; 8 Boxes per Case

*50 p/ Box

6" Discs

Paper C-Weight with Tabs, Gold

SKU	Grit	Price per Box	
		Box	Case
P6.23-06060.DWT*	60	\$31.73	\$29.45
P6.23-06080.DWT	80	\$46.76	\$43.40
P6.23-06100.DWT	100	\$46.76	\$43.40
P6.23-06120.DWT	120	\$45.09	\$41.85
P6.23-06150.DWT	150	\$46.23	\$42.90
P6.23-06220.DWT	220	\$47.93	\$44.49

100 Discs per Roll; 8 Rolls per Case

*50 p/ Box

6" Velcro Hook and Loop, 6-Hole

SKU	Grit	Price per Box	
		Box	Case
P6.23-06060V6*	60	\$36.82	\$34.18
P6.23-06100V6	100	\$53.11	\$49.29
P6.23-06120V6	120	\$53.02	\$49.21
P6.23-06150V6	150	\$51.77	\$48.05
P6.23-06220V6	220	\$50.10	\$42.10

100 Discs per Roll; 8 Rolls per Case

*50 p/ Box

Tack Cloth



It removes dust, dirt, lint and sanding residue before and between coats! 100 p/ Case

SKU	Price per Each	
	Each	Case
660.2012	\$0.99	\$0.89

Pasco 5" Q711T Film Back



Film Back Discs

- Stearated Aluminum Oxide
- 3 Mil Film Backing
- 3 - 4 Times Longer Life

5" (No Holes) PSA Disc on Roll

SKU	Grit	Price per Roll	
		Roll	Case
P6.24-05080.DOR	80	\$58.20	\$54.02
P6.24-05100.DOR	100	\$45.07	\$41.83
P6.24-05120.DOR	120	\$49.60	\$46.04
P6.24-05150.DOR	150	\$45.09	\$41.85
P6.24-05180.DOR	180	\$50.10	\$46.50
P6.24-05220.DOR	220	\$53.44	\$49.60

100 Discs per Roll; 8 Rolls per Case

5" PSA Disc with Tabs

SKU	Grit	Price per Box	
		Box	Case
P6.24-05080.DWT	80	\$58.12	\$53.94
P6.24-05100.DWT	100	\$53.11	\$49.29
P6.24-05120.DWT	120	\$51.44	\$47.74
P6.24-05150.DWT	150	\$51.44	\$47.74
P6.24-05180.DWT	180	\$50.10	\$46.50
P6.24-05220.DWT	220	\$51.44	\$47.74

100 Discs per Box; 8 Boxes per Case

5" 5-Hole PSA Disc with Tabs

SKU	Grit	Price per Box	
		Roll	Case
P6.24-050805DWT	80	\$48.43	\$44.95
P6.24-051205DWT	120	\$46.76	\$43.40
P6.24-051805DWT	180	\$45.09	\$41.85
P6.24-052205DWT	220	\$45.09	\$41.85

100 Discs per Roll; 8 Rolls per Case

Pasco 5" Q711T Film Back Continued...

5" 5-Hole Velcro

SKU	Grit	Price per Box	
		Box	Case
P6.24-05080V5	80	\$58.12	\$53.94
P6.24-05120V5	120	\$51.44	\$47.74
P6.24-05150V5	150	\$51.77	\$48.05
P6.24-05180V5	180	\$46.76	\$43.40
P6.24-05220V5	220	\$53.07	\$49.26

100 Discs per Box; 8 Boxes per Case

5" 8-Hole Velcro

SKU	Grit	Price per Box	
		Box	Case
P6.24-05080V8	80	\$54.78	\$50.84
P6.24-05100V8	100	\$53.07	\$49.26
P6.24-05120V8	120	\$51.44	\$47.74
P6.24-05150V8	150	\$51.44	\$47.74
P6.24-05180V8	180	\$49.60	\$46.04
P6.24-05220V8	220	\$51.44	\$47.74

100 Discs per Box; 8 Boxes per Roll

5" 8-Hole PSA Disc with Tabs

SKU	Grit	Price per Box	
		Box	Case
P6.24-05080DWT	80	\$48.43	\$44.95
P6.24-05100DWT	100	\$46.76	\$43.40
P6.24-05120DWT	120	\$65.63	\$60.92
P6.24-05150DWT	150	\$48.43	\$44.95
P6.24-05180DWT	180	\$45.09	\$41.85
P6.24-05220DWT	220	\$50.10	\$46.50

100 Discs per Box; 8 boxes per Case

Glue & Heavy-Duty Adhesive



960.PRO2-100 100 Watt \$39.99

100 W Glue Gun
Industrial high temperature glue gun delivers approximately 2.5 pounds of glue per hour with 100 watts of heating power.

220 W High Temp Glue Gun



960.PRO2-220HT 200 Watt (Commercial) \$130.21

The 220 w glue gun can reach a high temperature of 380° F with a heat up time of just 3 minutes! It uses 7/16" (.43") glue sticks and includes a heavy duty wide detachable metal stand.

Glue Sticks

SKU	Description	Price per Lb.	
		1 lb.	25 lbs.
Wood Assembly Glue Sticks			
960.738R10	7/16" x 10", 15 Sec. Open Time	\$7.92	\$6.61
960.739R10	7/16" x 10", 25 Sec. Open Time	\$7.99	\$6.68
Glue Sticks for Packaging			
960.7011715	7/16" x 15"	\$6.88	\$5.74



Construction Adhesive

An industrial-strength, multi-purpose adhesive with a self-leveling formula. It is waterproof, flexible, paintable, and nonflammable. This Adhesive is non-corrosive and not affected by most chemicals.

SKU	Size	Case Qty	Price per Each	
			Each	Case
E-6000 Clear Medium Viscosity				
64.230021	3.7 oz Tube	12	\$6.83	\$6.09
64.232021	10.2 oz Cartridge	12	\$6.83	\$6.09
E-6100 Clear Non-Slump				
64.252011	10.2 oz Cartridge	12	\$7.25	\$6.47



Camie Contact Adhesive

Camie 393 Trim & Laminate Adhesive is formulated to bond substrates that require either high-bond strength and/or temperature resistance.

SKU	Size	Case Qty	Price per Each	
			Each	Case
66.393	16.5 oz.	12	\$13.46	\$12.34



Little Red Cap

These little rubber caps will help your glue not to clog and will prevent messes! They simply roll on and off which provide an easy solution to capping your containers.

SKU	Description	Case
FC.LRC	35 per Container; 100 Boxes per Case	\$5.98



Empty Glue Bottle and Cap

Custom Service Hardware offers our 16 oz. no-stick glue bottle. It works well and with the cap's thin tip, the set makes it easy to get that glue exactly where you want! (Bottle and Cap Sold Separately)

96.60007	Screw-on Cap	\$0.35
96.60003	No-Stick Bottle	\$1.09



Dri-Res Glue

Mix Ratio: 2 Parts Powder to 1 Part Water (One Gallon of Water = 8 lbs)
Optimal water temperature is 70-78 degrees F

CSH.DR.5	5 lb. Can	\$25.58
CSH.DR.25	25 lb. Can	\$125.00
CSH.DR.100	100 lb. Can	\$350.70



GlüBot, Babe Bot & Accessories



The GlüBot from FastCap is the only glue bottle that will not drip or spill. You never have to clean up glue spills or drips again!



SKU	Description	Price
GlüBot Products and Accessories		
FC.GB.GLU-BOT	16 oz. Glü-Bot Bottle	\$7.99
FC.GB.LIDRING	Lid & Retaining Ring	\$1.34
FC.GB.G.REDCAP	Red Caps (5 Pack)	\$1.34
FC.GB.YORKERTIP	Yorker Tips (5 Pack)	\$1.34
FC.GB.BLADE.TIP	Blade Tips (5 Pack)	\$1.34
FC.GB.GUIDE	Guide (5 Pack)	\$2.64
FC.GB.GLUNIP	Glü-Nip for Bottles	\$6.67

Babe Bot Products and Accessories		
FC.GB.BABEBOT	4 oz. Babe Bot Bottle	\$5.32
FC.GB.BLIDRING	Lid & Retaining Ring	\$1.34
FC.GB.B.YORKTIP	Yorker Tips (5 Pack)	\$1.34
FC.GB.B.BLADTIP	Blade Tips (5 Pack)	\$1.34
FC.GB.B.REDCAP	Red Caps (5 Pack)	\$1.34



Titebond Construction Adhesive

Titebond Solvent Free Construction Adhesive is an American-made product that is safe for interior or exterior use. This product is waterproof and can be used on wet, frozen and treated lumber and for water cleanup.

SKU	Size	Case Qty	Price per Each	
			Each	Case
96.7471	10.5 oz	12	\$3.99	\$3.75



Gorilla Glue

- Easily bonds metal, stone, wood, ceramics, foam, glass and more
- 100% Waterproof
- Temperature resistant
- For indoor or outdoor use

SKU	Size	Case Qty	Price per Each	
			Each	Case
96.44.02	2 oz	16	\$5.65	\$4.85
96.44.08	8 oz	6	\$13.96	\$12.96
96.44.18	18 oz	6	\$21.54	\$20.00
96.44.36	36 oz	2	\$33.37	\$30.99



2P-10 Adhesive

2P-10 is a two-part, 10 second adhesive. Apply the adhesive, then spray the activator and stick together for a strong permanent bond. The 10 oz. bottles and 12 oz. Activator are sold individually for high production application; while the 2P-10 Kit is a great way to carry all of your compact glue products with you!

10 oz. Size

SKU	Description	Price
FC.2P10.THIN.8	10 oz. Thin	\$48.40
FC.2P10.MED.8	10 oz. Medium	\$48.40
FC.2P10.THICK.8	10 oz. Thick	\$48.40
FC.2P10.JEL.8	10 oz. Jel	\$66.18
FC.2P10.JELTUBE	10 oz. Jel Tube	\$66.18
FC.2P10S.ACT.12	12 oz. Activator	\$14.52



2 - 2.5 oz. Size

SKU	Description	Price
FC.2P10.KIT	2.25 oz. Kit	\$48.40
FC.2P10S.THK.2	2.25 oz. Thick	\$9.68
FC.2P10S.THIN.2	2.25 oz. Thin	\$9.68
FC.2P10S.MED.2	2.25 oz. Medium	\$9.68
FC.2P10S.JEL.2	2.25 oz. Jel	\$12.10
FC.2P10.DEBOND	2 oz. Debonder	\$9.68
FC.2P10.ACT	2 oz. Activator	\$9.68



2P-10 Micro-Tips



The 2.25" micro-tip is an excellent tool for precision application of any 2P-10 glue!

FC.2P10.MT 25 Pack \$9.20

2P-10 10 oz. Tips



2P-10 replacement tips will help you get going again while the included pin-caps will help keep your glue fresh and your new tip free from clogs. For 10oz bottles only.

FC.2P10TIPPK 3 Pack \$6.05

2P-10 Solo Kit



The 2P-10 Solo Kit contains 2 oz. 2P-10 Thick Adhesive and 12 oz. Activator. 2P-10 is a two-part ten-second adhesive. Just apply the adhesive, then spray the activator and stick it together.

FC.2P10.SOLO Solo Kit \$24.20



2P-10 Colorant Kit

This high tech colorant is specifically made to work with 2P-10 adhesive. Individual colors are also available.

FC.2P10COLORKIT \$72.60



Gorilla Heavy Duty Construction Adhesive

The Gorilla Glue Construction Adhesive can be used in all weather in as little as 30 seconds! Use it for painting, gap filling and more!

96.48.09 9 oz \$7.99

Adhesive & Tapes

Customer Service Hardware will help you find the right adhesive tapes and glues for all of your needs! Whether you need a thick adhesive for tough home improvement projects or transfer tape for veneering or laminating, we've got you covered!



Gorilla Tape

Gorilla Tape is made to stick to rough, uneven, unforgiving surfaces like wood, stone, stucco, plaster, brick and more. Heavy duty cloth backing gives extra strength and heft.

GG.TAPE 1.88" x 35 Yd \$10.33



Tape Dispenser

Fits up to a 2" x 220 yd. roll

62.006 Tape Dispenser \$14.95



Masking Tape

SKU	Price per Each		
	Each	Case Qty	Case
3/4" x 60 yds.			
3M.200.18	\$2.46	48	\$2.26
2" x 60 yds.			
3M.200.48	\$6.01	24	\$5.52



Clear Tape, 2" x 100 yds.

SKU	Price per Each		
	Each	Case Qty	Case
CSH.23199	\$2.42	36	\$2.22



Filament Tape, 18mm x 55m

SKU	Price per Each		
	Each	Case Qty	Case
3M.8934	\$4.96	48	\$4.65



Speed Tape is Fastcap's high performance ultra-bond adhesive in a peel & stick roll! Apply Speed Tape to almost anything you want to stick in place.

FC.ST.12.50	1/2" x 50'	\$6.05
FC.ST.1.50	1" x 50'	\$13.31
FC.ST.15.50	1 1/2" x 50'	\$19.98
FC.ST.2.50	2" x 50'	\$26.62
FC.ST.6.50	6 1/2" x 50'	\$79.86



Speed Roller Pro

Ergonomic Laminate Roller With Interchangeable Rollers (2 Non-marring Rubber Wheels and 2 Maximum PSI Steel Wheels)

FC.SPEEDROLLERPRO \$6.05



PVA Professional Wood Glue is an American-made product that comes in a variety of sizes, colors and types to fit all of your adhesive needs. It is also sandable, resists solvents and easy to clean up!



Wood Glue, 16 oz.
CSH.WG.16 \$4.99



PVA Professional Original Wood Glue

- Freeze-thaw stable
- Sandable
- Water cleanup
- Yellow color/dries opaque white
- High strength
- Low chalk point (40 degrees)
- 5-8 Min. open time*
- 15-20 Min. total assembly time*



SKU	Size	Price per Each		
		Each	Case Qty	Case
CSH.SG71.1	Gallon	\$27.68	4	\$25.68
CSH.SG71.5	5-Gallon Pail	\$108.97		N/A

PVA Professional Fast-Drying Wood Glue

- Sandable
- Water cleanup clear
- Chalk point 60-65 degrees
- Fast set
- Good impact resistance
- High solids
- 3-5 Min. open time*
- 10-15 Min. total assembly time*



SKU	Size	Price per Each		
		Each	Case Qty	Case
CSH.MG79.1	Gallon	\$27.68	4	\$25.68
CSH.MG79.5	5-Gallon Pail	\$106.88		N/A

PVA Professional Type 2 Water-Resistant Wood Glue

- Pre-catalyzed synthetic resin, water-based
- White color/dries clear
- Chalk point 60 degrees
- High solids
- Suitable for hot/cold press and RF use
- Superior bond strength
- Water cleanup
- 3-5 Min. open time*
- 10-15 Min. total assembly time*



SKU	Size	Price per Each		
		Each	Case Qty	Case
CSH.MG1000.1	Gallon	\$19.85	4	\$18.43
CSH.MG1000.5	5-Gallon Pail	\$106.88		N/A

PVA Professional Extended Open Time Wood Glue

- Resin modified PVA
- Water cleanup clear
- White color/dries clear
- Chalk point 45-50 degrees
- Sandable
- Extended open time of 10-12 minutes*
- Good impact resistance
- 20-25 Min. total assembly time*



SKU	Size	Price per Each		
		Each	Case Qty	Case
CSH.L-51481.1	Gallon	\$16.85	4	\$15.65
CSH.L-51481.5	5-Gallon Pail	\$91.77		N/A

*Cure time varies with climate and wood conditions. Approximate times given for 70 degrees and 50% relative humidity.

Franklin Multibond 1040 Adhesive

- Water resistant
- Durable
- Can withstand high temperature and humidity



SKU	Size	Price
FA.MB1040.5	5 Gallon	\$124.14 (\$24.80 per gallon)



Titebond Wood Glue provides a variety of products that will fit your adhesive needs. Each product develops a bond stronger than the wood itself, offers excellent sandability and its own unique features that will fit your customization needs!

Titebond® Original Wood Glue

- Fast Set
- Solvent-resistant
- Bonds stronger than wood
- Excellent sandability
- Easy cleanup w/water
- FDA approved for indirect food contact



SKU	Size	Case Quantity	Price per Each	
			Each	Case
96.5066	Gallon	2	\$23.80	\$21.97
96.5067	5-Gallon		\$144.51	N/A

Titebond® II Premium Wood Glue

- Passes ANSI Type II water-resistance testing
- FDA approved for indirect food contact
- Designed for exterior use
- Excellent sandability
- Easy cleanup w/water



SKU	Size	Case Qty	Price per Each	
			Each	Case
96.5006	Gallon	2	\$28.99	N/A
96.5007	5-Gallon		\$149.73	N/A

Titebond® II Extend Wood Glue

- Passes Type II water-resistance testing
- Slower speed of set and longer open time
- Solvent-resistant
- Excellent sandability

SKU	Size	Case Qty	Price per Each	
			Each	Case
96.4136	Gallon	2	\$34.99	\$31.99

Titebond® III Wood Glue

- Waterproof
- Easy cleanup with water
- FDA approved for indirect food contact
- Interior/exterior
- Longer assembly time



SKU	Size	Case Qty	Price per Each	
			Each	Case
96.1416	Gallon	2	\$38.34	\$35.60

Titebond® Melamine

- Bonds melamine, vinyl coated products and HPL to porous materials
- Fast setting, excellent strength
- Fast initial tack
- Thicker formulation, fewer runs and drips
- Dries clear



SKU	Size	Case Qty	Price per Each	
			Each	Case
96.4014	16 oz.	12	\$7.44	\$6.40
96.4016	Gallon	2	\$32.18	\$29.89
96.4017	5-Gallon		\$155.28	

Hardware Fasteners

Hidden Fasteners

Tongue and groove boards are used in many ways for interior construction. This simple fastening system allows the tongue and groove boards to fulfill their intended tasks, without displaying exposed fasteners or nails. Instead of leaving nails exposed and susceptible to rust and wear, or tediously covering every nail hole with wood filler, use these hidden fasteners!

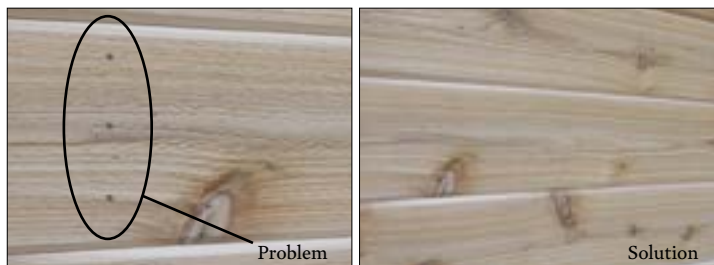

100 Interior Hidden Fasteners for Profile Boards with 10.5mm Groove Depth



FBS.4115-05-1

\$11.24

- Includes 100 10.5mm x 6mm tongue and groove clips and 100 3mm x 17mm phillips screws
- For safe installation of profile (tongue and groove) boards with a groove depth of 10.5mm
- For interior use
- Yellow-chromate coated steel
- Dimensions: 10.5mm hook depth x 6mm hook height
- Tested According to DIN 18168 standards
- Compatible with Home Depot 1-in. (23/32") T&G boards, and Menards 1" (23/32") T&G Carsiding WP4/116
- Coverage: 1 box = 50 square feet when used in combination with 6" T&G boards and 16" stud spacing

100 Interior Hidden Fasteners for Profile Boards with 8.5mm Groove Depth



FBS.4112-02-1

\$10.44

- Includes 100 8.5mm x 4mm tongue and groove clips and 100 3mm x 17mm phillips screws
- For safe installation of profile (tongue and groove) boards with a groove depth of 8.5mm
- For interior use
- Yellow-chromate coated steel
- Dimensions: 8.5mm hook depth x 4mm hook height
- Tested According to DIN 18168 standards
- Coverage: 1 box = 50 square feet when used in combination with 6" T&G boards and 16" stud spacing

Inserts

Insert, 1/4"-20 x 13 mm With Flush Flange Zinc



SKU	Description	Length	Case Qty	Price per Each	
				100	Case
16.1420.13D	W/ Flange	13mm	4,000	\$0.1301	\$0.062
16.1420.13E	No Flange	13mm	3,000	\$0.1148	\$0.0835
16.1420.20D	W/ Flange	20mm	2,500	\$0.1769	\$0.1287
16.1420.20E	No Flange	20mm	3,000	\$0.1642	\$0.1195
16.1420.25D	W/ Flange	25mm	2,000	\$0.2894	\$0.2107

Insert for Wooden Knobs and Handles 8-32 x 10mm Type E (No Flange)



SKU	Description	Length	Case Qty	Price per Each	
				Each	15,000
16.83210E.04*	No Flange	10mm	15,000	\$0.1072	\$0.0780

Allen Wrench



SKU	Length	Case Qty	Price per Each	
			Each	100
12.142012	4mm	100	\$0.34	\$0.29
12.HKSM5	5mm	100	\$0.34	\$0.29

*All Inserts use a 6mm Allen Wrench except this item (4mm Allen Wrench)

Nuts & Washers

Dowel Nuts, 10mm (0.394") Diameter



SKU	Size	Case Qty	Price Per Each	
			Each	Case
16.1420.1606	1/4" - 20 - 5/8"	3,000	\$0.27	\$0.19

T-Nuts



SKU	Size	Prongs	Case Qty	Price per Each	
				100-ct	Case
36.4088.02	1/4"-20 x 5/16"H	3	5,000	\$0.87	\$0.64
36.4089.02	5/16"-18 x 3/8"H	4	2,500	\$0.11	\$0.77
36.516.02	5/16"-18 x 5/8"H	3	2,500	\$0.16	\$0.12
36.4091.02	3/8"-16 x 7/16"H	4	2,000	\$0.13	\$0.95
36.4090.02	8 mm	4	2,500	\$0.13	\$0.05

Hex Nut



SKU	Description	Case Qty	Price per Each	
			100-ct	Case
14.250.04	1/4" - 20 Zinc	5,000	\$0.39	\$0.03
14.516.04	5/16" - 18 Zinc	3,400	\$0.27	\$0.02

Nylon Locking Hex Nut



SKU	Description	Case Qty	Price per Each		
			100-ct	1000-ct	Case
14.250.04L	1/4" - 20 Zinc	6,000	\$0.04	\$0.27	\$0.02

Washers



SKU	Description	Case Qty	Price per Each	
			100-ct	Case
14.250.75.04	1/4" - 3/4" diameter	7,350	\$0.02	\$0.01
14.516.75.04	5/16" - 3/4" diameter	4,500	\$0.06	\$0.05

Bolts

Hanger Bolts



SKU	Size	Length	Case Qty	Price per Each	
				100	Case
14.832.075	#8 x 32	3/4"	5,000	\$0.05	\$0.04
14.1420.200	1/4" - 20	2"	3,000	\$0.09	\$0.07
14.1420.250	1/4" - 20	2 1/2"	2,000	\$0.12	\$0.10
14.1420.300	1/4" - 20	3"	1,750	\$0.14	\$0.12
14.1420.350	1/4" - 20	3 1/2"	1,250	\$0.14	\$0.12
14.51618.250	5/16" - 18	2 1/2"	1,500	\$0.15	\$0.12
14.51618.300	5/16" - 18	3"	1,250	\$0.20	\$0.18
14.51618.350	5/16" - 18	3 1/2"	1,000	\$0.20	\$0.18
Driver					
10.1420	1/4" - 20			\$5.99	
10.51618	5/16" - 18			\$5.99	

Draw Bolt



SKU	Size	Case Qty	Price per Each	
			Each	Case
14.2528.04	1/4 20 x 3 1/2	500	\$0.60	\$0.55

Sex Bolt



SKU	Color	Length	Case Qty	Price per Each	
				100	Case
Connects two 3/4" panels					
PM.M6X20.04	Nickel	6 x 20mm	1,500	\$0.13	\$0.11
PM.M6X25.04	Nickel	6 x 25mm	1,500	\$0.21	\$0.19
Connects two 5/8" panels					
PM.M6X14.04	Nickel	6 x 14mm	1,500	\$0.10	\$0.08
PM.M6X25.04	Nickel	6 x 25mm	1,500	\$0.21	\$0.19
Connects two 1 3/8" - 1 1/2" panels; metal screw with white plastic caps					
16.1230.01	n/a	n/a	1,000	\$0.20	\$0.17

Wall Anchors & Hangers

Wall Anchors

- Drills its own hole and drives into the wall in one motion.
- Use with #6 sheet metal or drywall screws.
- Drives best with #3 square drive bit.



"I live in a mobile home and these anchors are the best we have ever used. They do not pull out!"

Price per Each

SKU	Description	Each	1,000	5,000
0.FPC08ZIPN	Wall Anchor, Nylon	\$.52	\$0.14	\$0.11

— Linda

The Tool-less Countertop Connector

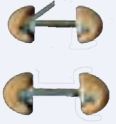

FC.FB FlipBolt

\$1.34

FlipBolt Jig Template

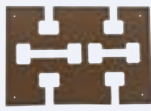

FC.FLIPBJIG Template

\$13.31

Surface Mount the FlipBolt



FC.JHOOK J-Hook

\$4.00

1/4" 20 KD Bolts



KD Bolt, Stat Bronze Finish



KD Bolt, Zinc Finish



KD Nut, Zinc

Price per Each

SKU	Finish	Length	Thread Length	Case Qty	Each	Case
-----	--------	--------	---------------	----------	------	------

KD Nut, 17mm Head, 5mm Hex Drive, 1/4" 20 Thread

16.BB1420017.02	Zinc	18mm	NA	2,400	\$0.31	\$0.22
16.BB1420017.05	Stat Bronze	18mm	NA	2,400	\$0.34	\$0.24
16.BB1420017.08	Black	18mm	NA	2,400	\$0.44	\$0.32
16.JCN142012.08	Black	12mm	NA	3,000	\$0.25	\$0.18

17mm Head, 4mm Hex Drive 1/4" 20 Thread

16.BB1420012.08	Black	12	12	3,000	\$0.09	\$0.07
16.BB1420018.08	Black	18	18	3,000	\$0.12	\$0.09
16.BB1420020.02	Zinc	20	20	2,400	\$0.22	\$0.16
16.BB1420020.08	Black	20	20	2,400	\$0.11	\$0.08
16.BB1420030.08	Black	30	20	2,000	\$0.17	\$0.12
16.BB1420035.02	Zinc	35	25	1,800	\$0.15	\$0.11
16.BB1420035.08	Black	35	25	1,800	\$0.18	\$0.13
16.BB1420040.08	Black	40	30	1,600	\$0.19	\$0.14
16.BB1420045.02	Zinc	45	30	1,500	\$0.19	\$0.14
16.BB1420045.08	Black	45	30	1,500	\$0.15	\$0.11
16.BB1420050.08	Black	50	30	1,400	\$0.20	\$0.15
16.BB1420060.05	Stat Bronze	60	40	1,200	\$0.20	\$0.14
16.BB1420070.08	Black	70	40	900	\$0.17	\$0.12
16.BB1420080.02	Zinc	80	40	800	\$0.17	\$0.12
16.BB1420080.05	Stat Bronze	80	40	800	\$0.28	\$0.20
16.BB1420090.02	Zinc	90	40	600	\$0.25	\$0.18
16.BB1420090.05	Stat Bronze	90	40	600	\$0.27	\$0.20
16.BB1420100.05	Stat Bronze	100	40	500	\$0.45	\$0.33
16.BB1420110.05	Stat Bronze	110	40	500	\$0.46	\$0.34
16.BB1420120.02	Zinc	120	40	500	\$0.38	\$0.27
16.BB1420120.05	Stat Bronze	120	40	500	\$0.50	\$0.36

13mm Head, 4mm Hex Drive 1/4" 20 Thread

16.BC1420030.02	Zinc	30	20	2,000	\$0.10	\$0.08
16.BC1420040.02	Zinc	40	30	1,600	\$0.13	\$0.09
16.BC1420050.02	Zinc	50	30	1,400	\$0.14	\$0.10
16.BC1420050.08	Black	50	30	1,400	\$0.13	\$0.10

Cabinet Hanging Brackets & Rails

The One-Man Cabinet Hanging System!

Brackets, White

SKU	Description	Weight Cap.	Case Qty	Price per Each	
				Each	Case
H.1019619	LH Bracket	140 lbs.	100	\$3.13	\$2.65
H.1019618	RH Bracket	140 lbs.	100	\$3.13	\$2.65

Rails

SKU	Description	Case Qty	Price per Each	
			Each	Case
H.53000000	8' Steel Hanging Rail	25	\$8.60	\$5.74
26.02.096.WHITE	8' White Cover	50	\$4.93	\$4.20

UPS "over size" shipments

RocLoc, 1/2"



- Comes with ten 1/4" PowerHead Screws
- Easy to install
- Removable and reusable

FC.ROCLOC10PK RocLocs (10 pack) \$13.31

Smart Cleat 4' Length



The Smart Cleat allows you unlimited adjustment without shims and allows you to hang the panel only 1/16" from the ceiling to eliminate excess trim. Great for hanging panels, false walls or large frames. Fasten with powerhead

screws to provide a solid mount and shim-free adjustment.

- Smart Cleat
- 48" Long
- 1/4" Thick
- 1 7/16" Wide

Speed Brace Anchor for Metal Stud



- Speed Brace Anchor for Metal Studs
- 2" Long
- Pack of 10
- Includes screws

FC.SB-ANCHOR10PC \$13.92

FC.SMARTCLEAT \$13.31

Panel Fasteners

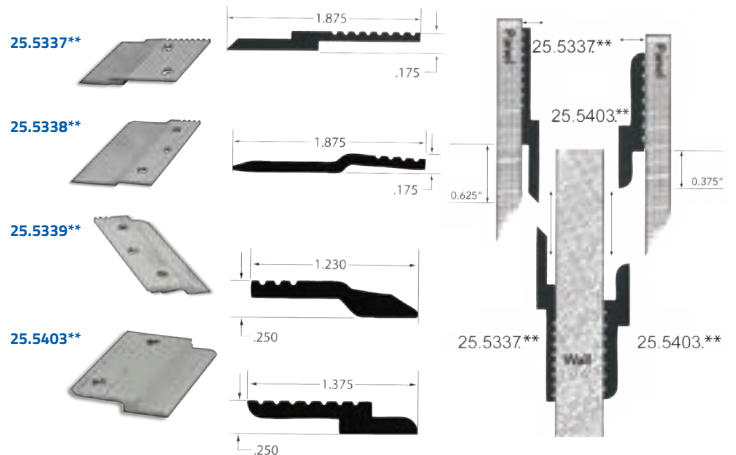

SKU	Description	Length	Case Qty	Price per Each	
				Each	Case
25.5337.015	2 - #8 screw holes	1-1/2"	500	\$0.40	\$0.30
25.5337.048	No screw holes	48"	40	\$5.99	\$4.79
25.5338.003 *	3 - #8 screw holes	3"	500	\$0.38	\$0.32
25.5338.048 *	No screw holes	48"	40	\$6.35	\$5.31
25.5339.003 *	3 - #8 screw holes	3"	500	\$0.34	\$0.29
* #25.5339 should not be used with itself, but can be used with # 25.5338 above.					
25.5403.002	2 - #8 screw holes	2"	500	\$0.40	\$0.33
25.5403.048	No screw holes	48"	40	\$5.99	\$4.75

Recommended screw 0.FPC08.

Connector Fittings

VB 35 Cam Fitting without Lip



SKU	Description	Case Qty	Price per Each		
			Each	1,000	
H.1019479	19mm Material, White	1,000	\$0.27	\$0.2109	

VB 35 Cam Fitting with Lip



SKU	Description	Case Qty	Price per Each		
			Each	1,000	
H.065505	19mm Material, Nickel-Plated	500	\$0.4694	\$0.3919	

VB 36 Cam Fitting with Lip



SKU	Description	Case Qty	Each	
H.9129805	16mm Material, White	500	\$0.37	

Rastex 15 Cam Fitting



SKU	Description	Case Qty	Price per Each		
			Each	Case	
H.1007792	19mm Panel w/o Rim	2,000	\$0.120	\$0.0754	

Rastex Twister Dowels



SKU	Description	Case Qty	Price per Each		
			Each	Case	
H.9047644	5mm Hole / 30mm Length	2,000	\$0.060	\$0.0527	
H.9047862	5mm Hole / 20mm Length	2,000	\$0.080	\$0.0703	

Screw-in Dowel, For 5mm Hole 12mm Deep



SKU	Description	Case Qty	Price per Each		
			Each	Case	
H.1019686	6.7 Dowel Length, Die-Cast Zinc	5,000	\$0.1250	\$0.1058	

Double Dowel



SKU	Description	Case Qty	Price per Each		
			Each	Case	
H.1024947	16mm Material, Nickel Finish	1,000	\$0.19	\$0.1506	
H.1019463	19mm Material, Nickel Finish	1,000	\$0.170	\$0.1582	

Screws

Search online (www.cshardware.net/screwfinder) to find just what you're looking for!

High Quality Assembly Screws

Auger Point

Square - Phillips Combo Drive

Type 17 Point

Self-Countersinking Head with 4 Nibs

Flat Head, Combo Drive, Coarse Thread, #8, Zinc, Nibs, Double Auger



SKU	Size	100-ct	1,000-ct	Case Qty	Price per 1,000		
					Case	10-Cases	
O.FCC08114ZN27	8 x 1 1/4"	\$6.50	\$18.00	9,000	\$14.00	\$12.00	
O.FCC08112ZN27	8 x 1 1/2"	\$5.60	\$15.00	7,000	\$12.00	\$11.00	
O.FCC08200ZN27	8 x 2"	\$7.00	\$19.00	3,500	\$15.00	\$13.00	
O.FCC08214ZN27	8 x 2 1/4"	\$9.60	\$26.00	3,000	\$21.00	\$18.00	
O.FCC08212ZN27	8 x 2 1/2"	\$11.80	\$32.00	2,500	\$25.00	\$22.00	

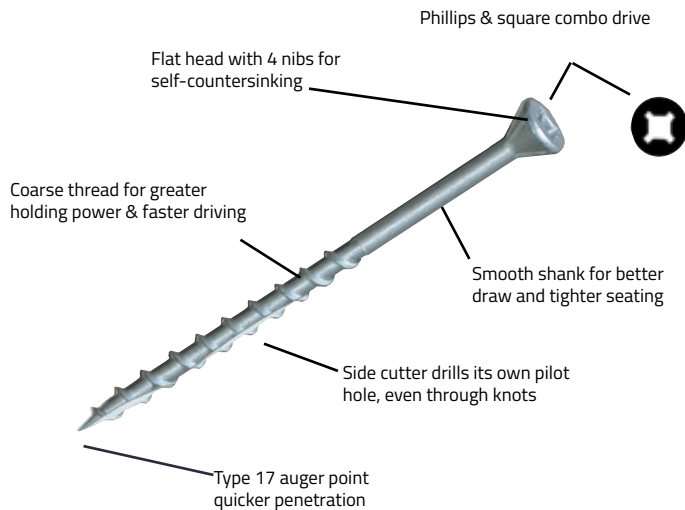

Flat Head, Combo Drive, Coarse Thread, #8, Zinc, Nibs, Type 17



SKU	Size	100-ct	1,000-ct	Case Qty	Price per 1,000	
					Case	10-Cases
O.FCC08100ZN17	8 x 1"	\$8.60	\$23.00	11,000	\$18.00	N/A
O.FCC08114ZN17	8 x 1 1/4"	\$5.80	\$16.00	9,000	\$13.00	\$11.00
O.FCC08112ZN17	8 x 1 1/2"	\$6.70	\$18.00	7,000	\$14.00	\$12.00
O.FCC08158ZN17	8 x 1 5/8"	\$6.10	\$17.00	5,500	\$13.00	\$12.00
O.FCC08134ZN17	8 x 1 3/4"	\$5.70	\$16.00	5,000	\$12.00	\$11.00
O.FCC08200ZN17	8 x 2"	\$8.30	\$23.00	3,500	\$18.00	\$16.00
O.FCC08300ZN17	8 x 3"	\$14.10	\$38.00	2,000	\$30.00	\$26.00

Flat Head, Square Drive, Coarse Thread, #8, Zinc, Nibs, Type 17



SKU	Size	100-ct	1,000-ct	Case Qty	Price per 1,000	
					Case	10-Cases
O.FSC08100ZN17	8 x 1"	\$4.90	\$13.00	11,000	\$11.00	\$9.00
O.FSC08118ZN17	8 x 1 1/8"	\$4.80	\$13.00	10,000	\$10.00	\$9.00
O.FSC08114BN17*	8 x 1 1/4"	\$5.60	\$15.00	9,000	\$12.00	\$11.00
O.FSC08114ZN17	8 x 1 1/4"	\$80.00	\$22.00	9,000	\$17.00	\$15.00
O.FSC08112ZN17	8 x 1 1/2"	\$4.80	\$13.00	7,000	\$10.00	\$9.00
O.FSC08158ZN17	8 x 1 5/8"	\$7.10	\$19.00	6,000	\$15.00	\$13.00
O.FSC08134ZN17	8 x 1 3/4"	\$10.20	\$28.00	5,500	\$22.00	\$19.00
O.FSC08200ZN17	8 x 2"	\$6.10	\$17.00	4,000	\$13.00	\$12.00
O.FSC08214ZN17	8 x 2 1/4"	\$6.90	\$19.00	3,000	\$15.00	\$13.00
O.FSC08212ZN17	8 x 2 1/2"	\$12.10	\$33.00	2,500	\$26.00	\$22.00
O.FSC08300ZN17	8 x 3"	\$14.20	\$38.00	2,000	\$30.00	\$26.00

*Black Oxide

Flat Head, Phillips Drive, Coarse Thread, #8, Zinc, Nibs



SKU	Size	100-ct	1,000-ct	Case Qty	Price per 1,000	
					Case	10-Cases
O.FPC08100ZN	8 x 1"	\$3.60	\$10.00	11,000	\$8.00	\$7.00
O.FPC08114ZN	8 x 1 1/4"	\$5.40	\$15.00	9,000	\$12.00	\$10.00
O.FPC08200ZN	8 x 2"	\$7.90	\$21.00	4,000	\$17.00	\$15.00

Flat Head, Combo Drive, Coarse Thread, #8, Black, Nibs, Type 17



SKU	Size	100-ct	1,000-ct	Case Qty	Price per 1,000	
					Case	10-Cases
O.FCC08100BN17	8 x 1"	\$3.80	\$11.00	11,000	\$8.00	\$7.00
O.FCC08114BN17	8 x 1 1/4"	\$5.83	\$17.60	7,500	\$13.90	\$10.90
O.FCC08112BN17	8 x 1 1/2"	\$5.20	\$14.00	5,000	\$11.00	\$10.00
O.FCC08158BN17	8 x 1 5/8"	\$7.00	\$19.00	5,500	\$15.00	\$13.00
O.FCC08134BN17	8 x 1 3/4"	\$6.10	\$17.00	5,000	\$13.00	\$13.00
O.FCC08200BN17	8 x 2"	\$8.10	\$22.00	4,000	\$17.00	\$15.00
O.FCC08212BN17	8 x 2 1/2"	\$11.80	\$32.00	2,500	\$25.00	\$22.00
O.FCC08300BN17	8 x 3"	\$13.90	\$37.00	1,500	\$30.00	\$26.00

Drywall Screws

Bugle Head, Phillips Drive, Coarse Thread, Black Oxide Finish

SKU	Size	Price per 1,000				
		100-ct	1,000-ct	Case Qty	Case	10-Cases
0.BPC06100B	6 x 1"	\$3.70	\$10.00	10,000	\$8.00	\$7.00
0.BPC06114B	6 x 1 1/4"	\$4.20	\$12.00	8,000	\$9.00	\$8.00
0.BPC06112B	6 x 1 1/2"	\$5.20	\$14.00	6,000	\$11.00	\$10.00
0.BPC06158B	6 x 1 5/8"	\$11.10	\$30.00	5,000	\$30.00	\$24.00
0.BPC06200B	6 x 2"	\$6.50	\$18.00	3,500	\$14.00	\$12.00
0.BPC08212B	8 x 2 1/2"	\$23.90	\$64.00	2,500	\$50.00	\$44.00
0.BPC08300B	8 x 3"	\$29.30	\$79.00	2,000	\$62.00	\$54.00
0.BPC10112B	10 x 1 1/2"	\$17.00	\$46.00	1,750	\$36.00	\$31.00

Case Quantities may vary. Other sizes available, minimums may apply.

Undercut Head Screws

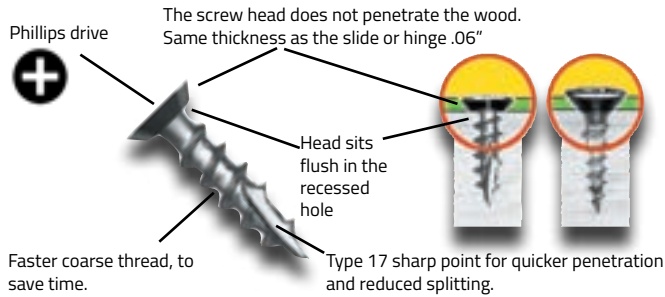

Type 17 point for quicker penetration and reduced splitting. Designed to reduce splitting in hardwoods. For applications that are attached into or near the edge of material. No pilot hole required in most woods

Flat Undercut Head, Phillips drive, Coarse thread, #6, Zinc, Type 17

SKU	Size	Price per 1,000				
		100-ct	1,000-ct	Case Qty	Case	10-Cases
0.FPUC06716Z17	6 x 7/16"	\$2.10	\$6.00	25,000	\$5.00	\$4.00
0.FPUC06012Z17	6 x 1/2"	\$3.10	\$9.00	25,000	\$7.00	\$6.00
0.FPUC06058Z17	6 x 5/8"	\$3.30	\$9.00	25,000	\$7.00	\$6.00

Flat Undercut Head, Phillips drive, Coarse thread, #6, Zinc

SKU	Size	Price per 1,000				
		100-ct	1,000-ct	Case Qty	Case	10-Cases
0.FPUC06716Z5	6 x 7/16"	\$1.90	\$6.00	35,000	\$4.00	\$4.00

Screw Body is #6 and Head Size is a #5

Truss Head Screws



Truss Head, Phillips Drive, Coarse Thread

SKU	Size	Finish	Price per 1,000				
			100	1,000	Case Qty	Case	10-Cases
0.TPC06038Z	6 x 3/8"	Zinc	\$2.80	\$8.00	20,000	\$6.00	\$5.00
0.TPC06058AB	6 x 5/8"	Antique Brass	\$4.00	\$11.00	15,000	\$9.00	\$8.00
0.TPC06058Z	6 x 5/8"	Zinc	\$2.90	\$8.00	20,000	\$6.00	\$6.00
0.TPC06012Z	6 x 1/2"	Zinc	\$3.30	\$10.00	22,000	\$7.90	\$6.20
0.TPC080716Z	8 x 7/16"	Zinc	\$5.50	\$15.00	20,000	\$12.00	\$10.00
0.TPC08012Z	8 x 1/2"	Zinc	\$3.80	\$11.00	15,000	\$8.00	\$7.00
0.TPC08058AB17*	8 x 5/8"	Antique Brass	\$4.70	\$13.00	10,000	\$10.00	\$9.00
0.TPC08058Z17*	8 x 5/8"	Zinc	\$4.60	\$13.00	10,000	\$10.00	\$9.00
0.TPC08034Z17*	8 x 3/4"	Zinc	\$4.20	\$12.00	12,000	\$9.00	\$8.00
0.TPC08034AB17*	8 x 3/4"	Antique Brass	\$04.80	\$13.00	10,000	\$10.00	\$9.00
0.TPC08100Z	8 x 1"	Zinc	\$5.50	\$15.00	8,000	\$12.00	\$10.00
0.TPC10058Z	10 x 5/8"	Zinc	\$12.60	\$34.00	10,000	\$27.00	\$23.00

* Type 17 Auger Point

Flat Head Screws



Phillips Drive - Flat Head, Coarse Thread

SKU	Size	Finish	Price per 1,000				
			100	1,000	Case Qty	Case	10-Cases
0.FPC04012PB	4 x 1/2"	Polished Brass	\$1.87	\$5.70	55,000	\$4.30	\$3.40
0.FPC04012SB	4 x 1/2"	Stat Bronze	\$2.30	\$6.00	50,000	\$5.00	\$4.00
0.FPC04058AB	4 x 5/8"	Antique Brass	\$2.10	\$6.00	20,000	\$5.00	\$4.00
0.FPC04058PB	4 x 5/8"	Polished Brass	\$5.10	\$14.00	45,000	\$11.00	\$10.00
0.FPC05012Z	5 x 1/2"	Zinc	\$3.20	\$9.00	25,000	\$7.00	\$6.00
0.FPC05012AB	5 x 1/2"	Antique Brass	\$5.40	\$15.00	40,000	\$12.00	\$10.00
0.FPC05012PB	5 x 1/2"	Polished Brass	\$2.00	\$6.00	30,000	\$5.00	\$4.00
0.FPC05058Z	5 x 5/8"	Zinc	\$1.90	\$6.00	15,000	\$4.00	\$4.00
0.FPC05058AB	5 x 5/8"	Antique Brass	\$2.80	\$8.00	25,000	\$6.00	\$5.00
0.FPC05058B	5 x 5/8"	Black	\$2.10	\$6.00	30,000	\$5.00	\$4.00
0.FPC05058PB	5 x 5/8"	Polished Brass	\$2.00	\$6.00	25,000	\$5.00	\$4.00
0.FPC06012Z	6 x 1/2"	Zinc	\$2.70	\$7.00	25,000	\$6.00	\$5.00
0.FPC06012AB	6 x 1/2"	Antique Brass	\$0.70	\$7.00	25,000	\$6.00	\$5.00
0.FPC06058B	6 x 5/8"	Black	\$2.90	\$8.00	30,000	\$6.00	\$6.00
0.FPC06058Z17*	6 x 5/8"	Zinc	\$3.52	\$10.70	30,000	\$8.40	\$6.60
0.FPC06058AB	6 x 5/8"	Antique Brass	\$3.50	\$10.00	25,000	\$8.00	\$7.00
0.FPC06058PB	6 x 5/8"	Polished Brass	\$18.60	\$50.00	25,000	\$39.00	\$34.00
0.FPC06034Z	6 x 3/4"	Zinc	\$2.60	\$7.00	24,000	\$6.00	\$5.00
0.FPC06034Z17*	6 x 3/4"	Zinc	\$3.60	\$10.00	24,000	\$8.00	\$7.00
0.FPC06034AB	6 x 3/4"	Antique Brass	\$9.90	\$27.00	20,000	\$21.00	\$18.00
0.FPC06034PB	6 x 3/4"	Polished Brass	\$3.00	\$8.00	20,000	\$7.00	\$6.00
0.FPC06114Z	6 x 1 1/4"	Zinc	\$3.60	\$10.40	10,000	\$8.60	\$8.00
0.FPC08012Z17	8 x 1/2"	Zinc	\$2.50	\$7.00	20,000	\$6.00	\$5.00
0.FPC08058PB	8 x 5/8"	Polished Brass	\$8.80	\$24.00	5,000	\$19.00	\$16.00
0.FPC08058Z17*	8 x 5/8"	Zinc	\$3.00	\$11.50	14,000	\$8.60	\$6.90
0.FPC08034Z	8 x 3/4"	Zinc	\$3.90	\$11.00	10,000	\$9.00	\$8.00
0.FPC08100ZN	8 x 1"	Zinc	\$3.60	\$10.00	11,000	\$8.00	\$7.00
0.FPC08114Z	8 x 1 1/4"	Zinc	\$14.70	\$40.00	9,000	\$31.00	\$27.00
0.FPC08114ZN	8 x 1 1/4"	Zinc	\$5.40	\$15.00	9,000	\$12.00	\$10.00
0.FPC08112Z	8 x 1 1/2"	Zinc	\$4.80	\$13.00	7,000	\$10.00	\$9.00
0.FPC08200ZN	8 x 2"	Zinc	\$7.90	\$21.00	4,000	\$17.00	\$15.00

** Fine Thread
*Type 17 Auger Point



Square Drive, Type 17 - Flat Head, Coarse Thread

SKU	Size	Finish	Price per 1,000				
			100	1,000	Case Qty	Case	10-Cases
0.FSC06012PB17	6 x 1/2"	Polished Brass	\$2.60	\$7.00	25,000	\$6.00	N/A
0.FSC06012Z17	6 x 1/2"	Zinc	\$2.10	\$6.00	25,000	\$5.00	\$4.00
0.FSC06058AB17	6 x 5/8"	Antique Brass	\$3.10	\$9.00	25,000	\$7.00	\$6.00
0.FSC06058PB17	6 x 5/8"	Polished Brass	\$3.10	\$9.00	25,000	\$7.00	\$6.00
0.FSC06058Z17	6 x 5/8"	Zinc	\$3.00	\$8.00	25,000	\$7.00	\$6.00
0.FSC06100B17	6 x 1"	Black	\$4.00	\$11.00	10,000	\$9.00	\$8.00
0.FSC06112Z17	6 x 1 1/2"	Zinc	\$5.30	\$14.00	8,000	\$11.00	\$10.00
0.FSC08034B	8 x 3/4"	Black	\$3.30	\$12.80	15,000	\$9.60	\$7.70
0.FSC08114B	8 x 1 1/4"	Black	\$5.40	\$15.00	9,000	\$11.00	\$10.00
0.FSC08112B	8 x 1 1/2"	Black	\$6.10	\$17.00	7,000	\$13.00	\$12.00
0.FSC08158ZN17	8 x 1 5/8"	Zinc	\$7.10	\$19.00	6,000	\$15.00	\$13.00

Flat Head, Phillips Drive, Coarse Thread, Zinc



SKU	Size	Price per 1,000				
		100-ct	1,000-ct	Case Qty	Case	10-Cases
0.FPC08114Z	8 x 1 1/4"	\$14.70	\$40.00	9,000	\$31.00	\$27.00
0.FPC08112Z	8 x 1 1/2"	\$4.80	\$13.00	7,000	\$10.00	\$9.00
0.FPC10034Z	10 x 3/4"	\$6.30	\$17.00	8,000	\$14.00	\$12.00

Flat Head, Square Drive, Coarse Thread, #8, Black



SKU	Size	Price per 1,000				
		100-ct	1,000-ct	Case Qty	Case	10-Cases
0.FSC08100B	8 x 1"	\$13.00	\$35.00	10,000	\$28.00	\$24.00
0.FSC08114B	8 x 1 1/4"	\$5.40	\$15.00	9,000	\$11.00	\$10.00
0.FSC08112B	8 x 1 1/2"	\$6.10	\$17.00	5,000	\$13.00	\$12.00
0.FSC08200B	8 x 2"	\$7.10	\$19.00	3,500	\$15.00	\$13.00
0.FSC08212B	8 x 2 1/2"	\$10.00	\$27.00	2,500	\$21.00	\$19.00
0.FSC08300B	8 x 3"	\$24.80	\$67.00	2,000	\$52.00	\$45.00

Flat Head, Combo Drive, Coarse Thread, Plain & Dri-Lube



SKU	Size	Price per 1,000				
		100-ct	1,000-ct	Case Qty	Case	10-Cases
0.FCC06058P	6 x 5/8"	\$2.10	\$6.00	25,000	\$5.00	\$4.00
0.FCC06114P	6 x 1 1/4"	\$3.80	\$11.00	8,000	\$8.00	\$7.00
0.FCC08100P	8 x 1"	\$8.90	\$24.00	10,000	\$19.00	\$16.00
0.FCC08114P	8 x 1 1/4"	\$4.18	\$16.50	9,000	\$10.00	\$7.80
0.FCC08112P	8 x 1 1/2"	\$4.60	\$13.00	5,000	\$10.00	\$9.00
0.FCC08134P	8 x 1 3/4"	\$5.20	\$14.00	5,000	\$11.00	\$10.00
0.FCC08200P	8 x 2"	\$6.80	\$18.00	4,000	\$15.00	\$13.00
0.FCC08214P	8 x 2 1/4"	\$7.90	\$21.00	3,000	\$17.00	\$15.00
0.FCC08212P	8 x 2 1/2"	\$7.50	\$31.20	2,500	\$23.30	\$18.60
0.FCC08300P	8 x 3"	\$10.80	\$29.00	2,000	\$23.00	\$20.00

Pocket Hole Screws

- No Splitting
- Call for Pallet Pricing
- Drills its Own Pilot Hole
- Best Screws & Prices Anywhere!

Coarse Thread

Modified Pan Head, Square Drive, Coarse Thread, #7, Plain & Dri-Lube, Type 17



SKU	Size	Price per 1,000				
		100-ct	1,000-ct	Case Qty	Case	10-Cases
0.MPSC07114P17	7 x 1 1/4"	\$6.04	\$18.30	7,500	\$14.50	\$11.30
0.MPSC07112P17	7 x 1 1/2"	\$6.00	\$16.00	6,000	\$13.00	\$11.00

Coarse Thread, for faster driving and superior holding in soft woods, MDF, plywood and particleboard.

Fast, High-Low Thread

Modified Pan Head, Square Drive, High-Low Thread, #7, Plain & Dri-lube, Type 17



SKU	Size	Price per 1,000				
		100-ct	1,000-ct	Case Qty	Case	10-Cases
0.MPSHL07114P17	7 x 1 1/4"	\$5.80	\$16.00	7,500	\$13.00	\$11.00
0.MPSHL07112P17	7 x 1 1/2"	\$6.60	\$18.00	6,000	\$14.00	\$12.00

High-Low Thread for greater holding power in hardwoods, medium woods, plywood and soft woods.

Fine Thread

Modified Pan Head, Square Drive, Fine Thread, #6, Plain & Dri-lube, Type 17



SKU	Size	Price per 1,000				
		100-ct	1,000-ct	Case Qty	Case	10-Cases
0.MPSF06078P17	6 x 7/8"	\$4.00	\$11.00	8,000	\$9.00	\$8.00
0.MPSF06100P17	6 x 1"	\$3.90	\$11.00	8,000	\$9.00	\$8.00
0.MPSF06114P17	6 x 1 1/4"	\$5.93	\$18.00	7,500	\$14.20	\$11.10
0.MPSF06112P17	6 x 1 1/2"	\$5.20	\$14.00	6,000	\$11.00	\$10.00

Standard Fine Thread, for hardwoods such as Oak and Maple.

Fine Thread

Modified Pan Head, Square Drive, Fine Thread, #6, Plain & Dri-lube, Double Auger



SKU	Size	Price per 1,000				
		100-ct	1,000-ct	Case Qty	Case	10-Cases
0.MPSF06114P27	6 x 1 1/4"	\$5.17	\$15.70	8,000	\$12.40	\$9.60
0.MPSF06112P27	6 x 1 1/2"	\$6.80	\$18.00	7,000	\$15.00	\$13.00

Double Auger Fine Thread, for extra hard woods that split easily.

Fast, High-Low Thread, Washer Head

Round Washer Head, #2 Square drive, High-Low thread, #7, Plain & dri-lube, Single Auger



SKU	Size	Price per 1,000				
		100-ct	1,000-ct	Case Qty	Case	10-Case
0.RWSHL07114P17	7 x 1 1/4"	\$5.00	\$13.00	8,000	\$10.00	\$9.00
0.RWSHL07112P17	7 x 1 1/2"	\$5.80	\$16.00	7,000	\$13.00	\$11.00

Round washer head prevents the head from crushing into the bottom of the pocket hole. High-Low Thread, for greater holding power in hardwoods, medium woods, plywood and soft woods.

Fine Thread, Washer Head

Standard Fine Thread, for hardwoods such as Oak and Maple.



SKU	Size	Price per 1,000				
		100-ct	1,000-ct	Case Qty	Case	10-Case
0.RWSF07114P17	7 x 1 1/4"	\$6.48	\$19.60	8,000	\$15.50	\$12.10
0.RWSF07112P17	7 x 1 1/2"	\$5.30	\$14.00	5,000	\$11.00	\$10.00

Kreg Pocket Hole Screws

Round Washer Head, #8, #2 Square Drive

KT.SML-C125B-1200	1 1/4" L #8, #2 Square Drive, Kote-Blue	1,200 Qty	\$74.99
KT.SML-C150-500	1 1/2" L #8 Coarse, Washer Head, Kote-Blue	500 Qty	\$28.99
KT.SML-C2B-250	2" L #8, #2 Square Drive, Kote-Blue	250 Qty	\$26.99
KT.SML-C2x250-30	2 1/2" L #14, #3 Square Drive, Steel	30 Qty	\$7.99

Pocket Hole Bits

SKU	Description	Each
KT.KJD		
KT.KPHA308	3/8" Step Drill, Kreg	\$18.99
KT.DKDB	3/8" Step Drill, 6 3/4" Long, Kreg Foreman Machine	\$44.99
WM.FF301	4" x 3/8" Carbide-Tipped Counterbore Bit	\$43.32
WM.FF303	Replacement Fishtail Drill Bit	\$7.39
90.304	8/32" Allen Set Screw Replacement	\$0.36
WM.CM-RU	3/8" Dia. x 3/8" Shank x 1" Cut Length, 4 Flute HSS	\$27.91
WM.CM-DB	9/64" Dia. x 1/4" Shank x 1" Cut Length HSS	\$14.92
WM.RU4000H	3/8" Dia. x 3/8" Shank x 1" Cutting Length, 3 Flute Carbide	\$61.48
Roughing Cobalt Endmills		
90.9645CD	9/64" Dia. (RH) Stub Cobalt Drill Bit	\$6.99
WM.1039	3/8" Dia. x 3/8" Shank x 2" L (for Castle Machines)	\$21.99
WM.1039 & WM.1062		
WM.1062	3/8" Dia. x 1/2" Shank x 2" L (for Porter Cable Machines)	\$21.99

Washer Head Screws

Coarse Thread, Washer Head

3/8" Round Washer Head, #2 Square Drive, Coarse Thread, #8, Black, Single Auger



SKU	Size	Price per 1,000				
		100-ct	1,000-ct	Case Qty	Case	10-Case
0.RWSC08012B17	8 x 1/2"	\$4.50	\$12.00	12,000	\$10.00	\$8.00
0.RWSC08058B17	8 x 5/8"	\$5.00	\$14.00	12,000	\$11.00	\$0.009
0.RWSC08034B17	8 x 3/4"	\$5.39	\$16.30	10,000	\$12.90	\$10.00
0.RWSC08100B17	8 x 1"	\$6.15	\$18.60	8,000	\$14.70	\$11.50
0.RWSC08118B17	8 x 1 1/8"	\$6.50	\$18.00	9,000	\$14.00	\$12.00
0.RWSC08114B17	8 x 1 1/4"	\$6.10	\$17.00	6,000	\$13.00	\$12.00
0.RWSC08114P17*	8 x 1 1/4"	\$6.48	\$19.60	8,000	\$15.50	\$12.10
0.RWSC08138B17	8 x 1 3/8"	\$7.10	\$19.00	5,000	\$19.00	\$19.00
0.RWSC08112B17	8 x 1 1/2"	\$7.60	\$21.00	5,000	\$16.00	\$14.00
0.RWSC08134B17	8 x 1 3/4"	\$7.70	\$21.00	4,000	\$17.00	\$14.00
0.RWSC08200B17	8 x 2"	\$9.20	\$25.00	4,000	\$20.00	\$17.00
0.RWSC08214B17	8 x 2 1/4"	\$8.70	\$23.00	3,000	\$19.00	\$16.00
0.RWSC08212B17	8 x 2 1/2"	\$11.20	\$30.00	2,500	\$26.80	\$23.00
0.RWSC08234B17	8 x 2 3/4"	\$9.90	\$27.00	1,500	\$21.00	\$18.00
0.RWSC08300B17	8 x 3"	\$11.50	\$31.00	1,500	\$24.00	\$21.00

Coarse Thread, for faster driving and superior holding in soft woods.

*Plain & Dri-Lube

Confirmat Screws

Good for:

- Partial board
- MDF Material

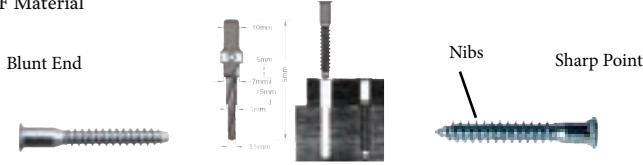

Pozi-Drive, Nickel-Finish, 7.0 x 50mm

Price per 1,000

SKU	Description	100-ct	1,000-ct	Case Qty	Case	10-Case
0.FPC7X50MMNB*	Blunt	\$92.20	\$246.00	2,000	\$388.00	\$3,340.00
0.FPC7X50MMNNS*	Sharp with Nibs	\$43.40	\$116.00	2,000	\$182.00	\$1,580.00

Recommended Drill Bit: AT.5592 - \$39.99

*100 Piece Minimum Order

Large Round Washer Head

1/2" Large Round Washer Head, Phillips Drive, Coarse Thread, #8, Zinc



Price per 1,000

SKU	Size	100-ct	1,000-ct	Case Qty	Case	10-Case
0.RWLPC08100Z	8 x 1"	\$7.10	\$19.00	7,000	\$15.00	\$13.00
0.RWLPC08114Z	8 x 1 1/4"	\$6.30	\$17.00	6,000	\$14.00	\$12.00

1/2" Large Round Washer Head, Combo Drive, Coarse Thread, #8, Zinc, Type 17

Price per 1,000

SKU	Size	100-ct	1,000-ct	Case Qty	Case	10-Case
0.RWLCC08078Z17	8 x 7/8"	\$16.00	\$50.00	8,000	\$38.00	\$32.00
0.RWLCC08100Z17	8 x 1"	\$7.40	\$20.00	5,500	\$16.00	\$14.00
0.RWLCC08118Z17	8 x 1 1/8"	\$7.90	\$21.00	5,000	\$17.00	\$15.00
0.RWLCC08114Z17	8 x 1 1/4"	\$12.50	\$34.00	4,000	\$27.00	\$23.00
0.RWLCC08112Z17	8 x 1 1/2"	\$19.20	\$51.00	5,000	\$41.00	\$35.00

Drawer Front Adjusters

Allows for the full adjustment of drawer fronts. It is a smart and time-saving way to align drawer fronts!

- Drill 20mm x 11mm hole in drawer fronts
- Press fitting in place
- Align box and front
- Two fittings recommended per front, two additional screws for final attaching

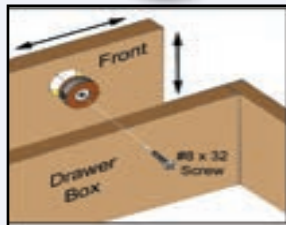

Price per Each

SKU	Diameter	Depth	Each	100
H.06308	20mm	11mm	\$0.20	\$0.18

Compatible with 1/2" Large Round Washer Heads

Cabinet Installation Screws

3/8" Round Washer Head, #2 Combo Drive, Coarse Thread, #8, Black, Nibs, Type 17

Price per 1,000

SKU	Size	100-ct	1,000-ct	Case Qty	Case	10-Case
0.RWCC08212Z17	8 x 2 1/2"	\$8.40	\$23.00	2,000	\$18.00	\$16.00

3/8" Round Washer Head, #2 Combo Drive, Coarse Thread, #8, Zinc

Price per 1,000

SKU	Size	100-ct	1,000-ct	Case Qty	Case	10-Case
0.RWCC08200Z	8 x 2"	\$24.40	\$65.00	4,000	\$52.00	\$045.00
0.RWCC08300Z	8 x 3"	\$9.70	\$26.00	1,500	\$21.00	\$18.00

1/2" Round Washer Head, #2 Combo drive, Coarse thread, #10, Zinc, Double Auger

Price per 1,000

SKU	Size	100-ct	1,000-ct	Case Qty	Case	10-Case
0.RWCC10212Z27	10 x 2 1/2", 1/2" Head	\$16.20	\$44.00	1,500	\$34.00	\$30.00
0.RWCC10300Z27	10 x 3", 1/2" Head	\$23.40	\$63.00	1,500	\$49.00	\$43.00

1/2" Round Washer Head, #2 Combo drive, Coarse thread, #10, White, Double Auger

Price per 1,000

SKU	Size	100-ct	1,000-ct	Case Qty	Case	10-Case
0.RWCC10212W27	10 x 2 1/2"	\$24.90	\$67.00	1,500	\$53.00	\$46.00
0.RWCC10300W27	10 x 3"	\$62.60	\$167.00	1,500	\$132.00	\$114.00

3/8" Round Washer Head, #2 Combo Drive, Coarse Thread, #8, Plain & Dri-Lube, Double Auger

Price per 1,000

SKU	Size	100-ct	1,000-ct	Case Qty	Case	10-Case
0.RWCC08300P27	8 x 3"	\$11.50	\$31.00	2,000	\$24.00	\$21.00

3/8" Round Washer Head, #2 Square Drive, Coarse Thread, #8, Black, Type #17

Price per 1,000

SKU	Size	100-ct	1,000-ct	Case Qty	Case	10-Case
0.RWSC08214B17	8 x 2 1/4"	\$8.70	\$23.00	3,000	\$19.00	\$16.00



Wood Screws #10 - #2 Square Drive, Zinc

SKU	Length	Case #	100-ct	1,000-ct	Case
FC.PHZ8255SQUARE	2 1/2"	1,500	\$9.00	\$72.80	\$93.00
FC.PHZ825SQUARE	2"	2,000	\$11.00	\$110.00	\$220.00
FC.PHZ835SQUARE	3"	1,500	\$13.00	\$127.40	\$162.75
FC.PHZ855SQUARE	5"	1,000	\$13.00	\$127.40	\$127.40

Wood Screws #10 - T20 Torx Drive, Zinc

SKU	Length	Case Qty	100-ct	1,000-ct	Case
FC.PHZ81125	1 1/8"	2,000	\$9.00	\$72.80	\$124.00
FC.PHZ8125	1 1/4"	2,000	\$8.00	\$72.80	\$124.00
FC.PHZ815	1 1/2"	2,000	\$8.00	\$72.80	\$124.00
FC.PHZ825	2 1/2"	1,500	\$9.00	\$72.80	\$93.00
FC.PHZ83	3"	1,500	\$12.00	\$109.20	\$139.50
FC.PHZ835	3 1/2"	1,000	\$13.00	\$127.40	\$127.40
FC.PHZ84	4"	1,000	\$15.00	\$145.60	\$145.60

Metal Screws #10 - #2 Square Drive, Zinc

SKU	Length	Case Qty	100-ct	1,000-ct	Case
FC.PHZ8ME1	1"	2,000	\$8.00	\$78.80	\$139.60
FC.PHZ8ME15	1 1/2"	2,000	\$10.00	\$72.80	\$124.00
FC.PHZ8ME2	2"	2,000	\$9.00	\$72.80	\$124.00
FC.PHZ8ME3	3"	1,500	\$13.00	\$127.40	\$162.75

Black Powerhead #10 - #2 Square Drive, Black Oxide

SKU	Length	Case Qty	100-ct	1,000-ct	Case
FC.PHBL25	2 1/2"	150	\$9.00	\$84.00	
FC.PHBL3	3"	150	\$12.00	\$95.00	

Phillips Oval Head Screws

Oval Head, Phillips Drive

Polished Brass

Price per 1,000

SKU	Size	Finish	100-ct	1,000-ct	Case Qty	Case	10-Case
0.OPF05058AB*	5 x 5/8"	Antique Brass	\$4.48	\$18.80	25,000	\$14.00	\$11.00
0.OPC05058AB	5 x 5/8"	Antique Brass	\$2.40	\$7.00	30,000	\$5.00	\$5.00
0.OPC05058PB	5 x 5/8"	Polished Brass	\$0.70	\$7.00	25,000	\$5.00	\$5.00
0.OPC06058AB	6 x 5/8"	Antique Brass	\$2.40	\$7.00	30,000	\$5.00	\$5.00

* Twinfast Thread

Machine Screws

#8 - 32 Thread, Fits all Standard Knobs

Truss Head, Combo Drive, Machine Thread, #8, Zinc

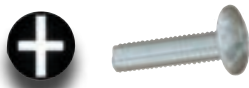

Price per 1,000

SKU	Length	100-ct	1,000-ct	Case Qty	Case	10-Case
0.TCM0832038Z	3/8"	\$5.40	\$15.00	20,000	\$12.00	\$10.00
0.TCM0832012Z	1/2"	\$3.90	\$11.00	14,000	\$9.00	\$8.00
0.TCM0832058Z	5/8"	\$5.00	\$14.00	12,000	\$11.00	\$9.00
0.TCM0832034Z	3/4"	\$5.80	\$16.00	10,000	\$13.00	\$11.00
0.TCM0832078Z	7/8"	\$6.00	\$16.00	8,500	\$13.00	\$11.00
0.TCM0832100Z	1"	\$7.17	\$27.70	7,500	\$21.70	\$17.20
0.TCM0832118Z	1 1/8"	\$8.00	\$20.00	6,500	\$16.00	\$14.00
0.TCM0832114Z	1 1/4"	\$30.80	\$83.00	5,500	\$65.00	\$56.00
0.TCM0832138Z	1 3/8"	\$6.80	\$18.00	5,000	\$15.00	\$13.00
0.TCM0832112Z	1 1/2"	\$6.90	\$18.00	4,500	\$14.00	\$12.00
0.TCM0832158Z	1 5/8"	\$9.50	\$26.00	4,000	\$20.00	\$18.00
0.TCM0832134Z	1 3/4"	\$35.00	\$94.00	4,000	\$74.00	\$64.00
0.TCM0832178Z	1 7/8"	\$14.60	\$39.00	3,500	\$31.00	\$27.00
0.TCM0832200Z	2"	\$0.15	\$0.039	3,000	\$0.031	\$0.027

Breakaway Machine Screw, 32 Thread, Truss Head, Phillips/Slot Head

Price per 1,000

SKU	Length	100-ct	1,000-ct	Case Qty	Case	10-Case
0.TCM0832BWZ	1 3/4"	\$22.00	\$59.00	\$46.00	\$40.00	\$23.00

Magnetic Driver Tip

The perfect combination of polarity, strength, and shape to make the Tip Magnet the most powerful accessory for your drill bit. Whether at the base of a 1" tip or a 6" extended tip, the magnetic transfer picks up multiple screws with ease.



- Tip Mag
- Magnetize Any Driver
- Powerful Neodymium Magnets
- Holds Screws On

FC.TIPMAG \$13.31

Decking Screws

ACQuickCutters™ for ACQ Treated Lumber

Flat head, Square Drive, Coarse Thread, #8, Zinc, Double Auger, Ultraguard



Price per 1,000

SKU	Size	100-ct	1,000-ct	Case Qty	Case	10-Case
0.FSC08114UN27	8 x 1 1/4"	\$10.10	\$27.00	8,000	\$22.00	\$19.00
0.FSC08158UN27	8 x 1 5/8"	\$9.80	\$34.90	5,000	\$26.00	\$21.00
0.FSC08134UN27	8 x 1 3/4"	\$12.50	\$36.50	5,000	\$29.20	\$24.40
0.FSC08200UN27	8 x 2"	\$11.00	\$30.00	4,000	\$23.00	\$20.00
0.FSC08214UN27	8 x 2 1/4"	\$38.80	\$104.00	3,000	\$82.00	\$71.00
0.FSC08212UN27	8 x 2 1/2"	\$12.90	\$35.00	2,500	\$27.00	\$24.00
0.FSC08300UN27	8 x 3"	\$21.90	\$59.00	2,000	\$46.00	\$40.00
0.FSC10400UN27	10 x 4"	\$96.10	\$257.00	1,000	\$257.00	\$202.00
0.FSC10412UN27	10 x 4 1/2"	\$74.70	\$200.00	800	\$160.00	\$157.00
0.FSC10500UN27	10 x 5"	\$54.90	\$147.00	500	\$147.00	\$115.00
0.FSC10600UN27	10 x 6"	\$101.90	\$272.00	500	\$272.00	\$214.00

Euro Screws



Flat Head, Pozi Drive, #6.3, Zinc

Price per 1,000

SKU	Size	100-ct	1,000-ct	Case Qty	Case	10-Case
0.FPZE63115Z	6.3 x 11.5mm	\$12.30	\$33.00	10,000	\$26.00	\$23.00
0.FPZE63013Z	6.3 x 13mm	\$8.20	\$22.00	10,000	\$18.00	\$15.00
0.FPZE63020Z*	6.3 x 20mm	\$7.46	\$25.90	5,000	\$22.80	\$18.20
0.FPZE63030Z	6.3 x 30mm	\$13.20	\$35.00	5,000	\$28.00	\$24.00

*Phillips Drive, 100 Piece Minimum Order, Square Drive Available

VIX-BIT, Self-Centering Drill



SKU	Description	Price
10.03	Fits #2 & 3 Screws	\$13.55
10.03B	Replacement 5/64" H.S. Drill	\$2.88
10.05	Fits #5 & 6 Screws	\$12.01
10.05B	Replacement 7/64" H.S. Drill	\$2.94
10.09	Fits #8 & 10 Screws	\$11.24
10.09B	Replacement 9/64" H.S. Drill	\$3.03

Pan Head Screws



Pan Head, Phillips Drive, Coarse Thread

Price per 1,000

SKU	Size	Finish	100	1,000	Case Qty	Case	10-Case
0.PPC02038PB	2 x 3/8"	Polished Brass	\$3.60	\$10.00	100,000	\$8.00	N/A
0.PPC06012AB17*	6 x 1/2"	Antique Brass	\$3.20	\$9.00	30,000	\$7.00	\$6.00
0.PPC06012Z	6 x 1/2"	Zinc	\$2.90	\$8.00	30,000	\$6.00	\$6.00
0.PPC06012Z17*	6 x 1/2"	Zinc	\$2.60	\$7.00	30,000	\$6.00	\$5.00
0.PPC06012B	6 x 1/2"	Black	\$2.90	\$8.00	30,000	\$6.00	\$6.00
0.PPC06058AB	6 x 5/8"	Antique Brass	\$3.90	\$11.00	25,000	\$9.00	\$8.00
0.PPC06058B	6 x 5/8"	Black	\$2.70	\$7.00	25,000	\$6.00	\$5.00
0.PPC06058Z	6 x 5/8"	Zinc	\$2.60	\$7.00	25,000	\$6.00	\$5.00
0.PPC06058Z17*	6 x 5/8"	Zinc	\$3.60	\$10.00	25,000	\$8.00	\$7.00
0.PPC06034B	6 x 3/4"	Black	\$3.00	\$8.00	20,000	\$7.00	\$6.00
0.PPC06034PB	6 x 3/4"	Polished Brass	\$14.00	\$38.00	20,000	\$30.00	\$26.00
0.PPC08012Z	8 x 1/2"	Zinc	\$7.40	\$20.00	15,000	\$16.00	\$14.00
0.PPC08012B	8 x 1/2"	Black	\$2.90	\$8.00	15,000	\$6.00	\$6.00
0.PPC08058Z17*	8 x 5/8"	Zinc	\$3.40	\$9.00	12,000	\$8.00	\$7.00
0.PPC08058PB	8 x 5/8"	Polished Brass	\$9.20	\$25.00	12,000	\$20.00	\$17.00
0.PPC08034B	8 x 3/4"	Black	\$4.50	\$12.00	10,000	\$10.00	\$8.00
0.PPC08034Z	8 x 3/4"	Zinc	\$14.00	\$38.00	10,000	\$30.00	\$26.00
0.PPC08034Z17*	8 x 3/4"	Zinc	\$4.70	\$13.00	10,000	\$10.00	\$9.00
0.PPC08100Z	8 x 1"	Zinc	\$3.60	\$10.00	9,000	\$8.00	\$7.00
0.PPC08100Z17*	8 x 1"	Zinc	\$9.25	\$37.10	9,000	\$27.00	\$22.00
0.PPC08112Z	8 x 1 1/2"	Zinc	\$7.00	\$22.50	6,000	\$18.00	\$18.00
0.PPC08114Z	8 x 1 1/4"	Zinc	\$17.10	\$46.00	9,000	\$36.00	\$36.00
0.PPC10012Z	10 x 1/2"	Zinc	\$6.30	\$17.00	9,000	\$14.00	\$12.00
0.PPC10058B	10 x 5/8"	Black	\$4.40	\$12.00	10,000	\$10.00	\$8.00
0.PPC10034B	10 x 3/4"	Black	\$4.50	\$12.00	7,000	\$10.00	\$8.00
0.PPC10034Z	10 x 3/4"	Zinc	\$5.80	\$16.00	7,000	\$13.00	\$11.00
0.PPC10100Z	10 x 1"	Zinc	\$13.00	\$35.00	7,000	\$28.00	\$24.00
0.PPC10100B	10 x 1"	Black	\$20.10	\$54.00	7,000	\$43.00	\$37.00
0.PPC10114Z	10 x 1 1/4"	Zinc	\$119.10	\$318.00	4,300	\$250.00	N/A
0.PPC12058Z	12 x 5/8"	Zinc	\$15.00	\$40.00	7,500	\$32.00	\$27.00
0.PPC14100Z	14 x 1"	Zinc	\$37.80	\$101.00	2,500	\$80.00	\$69.00
0.PPC14114Z	14 x 1 1/4"	Zinc	\$21.70	\$58.00	3,000	\$46.00	\$40.00
0.PPC14200B	14 x 2"	Black	\$194.40	\$408.00	1,000	\$408.00	\$352.00

*Type 17 Auger Point

Trim Head Screws

Twinfast Thread, #1 - Square Drive 1/4" Diameter Flat Head

Trim Head, Square Drive, Coarse Thread, #6, Black



SKU	Size	Price per 1,000				
		100-ct	1,000-ct	Case Qty	Case	10-Case
0.TFS06114B	6 x 1 1/4"	\$21.90	\$59.00	10,000	\$46.00	N/A
0.TFS06158B	6 x 1 5/8"	\$4.60	\$13.00	5,000	\$10.00	N/A
0.TFS06214B	6 x 2 1/4"	\$17.30	\$46.00	3,000	\$37.00	\$32.00

Case quantities may vary. Other sizes available, minimums may apply.

Driver Bit 2 3/4" #1 Square

SKU	Size	Each	10-ct
11.440.31	2 3/4"	\$0.79	\$0.69

Square Flex Screw Bag

- (9) larger compartments
- Identification Labels
- Storage for bits & pencils on the top and sides
- Scale for screw length identification
- Completely collapsible
- Heavy duty & durable

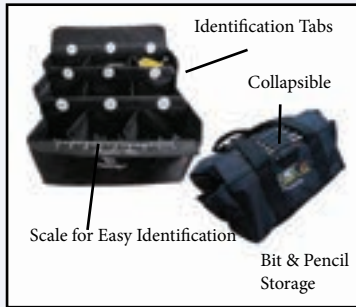

FC.FLEXBAGSQ \$33.29

Lag Screws



Screw Hex Lag, Zinc

SKU	Size	Length	Each
16.5169.150	1/4"	1 1/2"	\$0.18 WSL

Dowel Screws



SKU	Thread Size	Length	Case Qty	Price per Each	
				Each	Case
DS.1410.200	1/4" x10	2"	100	\$0.10	\$8.00
DS.1410.250	1/4" x 10	2 1/2"	100	\$0.13	\$11.73
DS.1410.350	1/4" x 10	3 1/2"	100	\$0.15	\$12.00

Drivers and Driver Bits

Whether for a quick fix or a major assembly project, the right driver bits can make the process a lot easier. It's always a good idea to keep a power drill nearby, and having high-quality driver bits is essential to getting the job done.

Micro FlushMount Drillbit System with Carbide Bit



FC.DB.CB.916.M	FlushMount Drill Bit, 1/16"	\$66.55
FC.INNERBIT.M	Inner Bit Replacement	\$6.67
FC.DB.18MM	FlushMount Drill Bit, 18mm	\$26.62
FC.DB.3/8	FlushMount Drill Bit, 3/8"	\$23.96

FLEX Bit Bag



The FLEX Bit Bag features clear pockets that fasten with hook & loop. This allows you to protect, separate, and organize your bits easily.

Includes: (6) Small pockets, (2) large pockets, & (1) wrench pocket.

FC.FLEXBITBAG \$24.20

Taper Lock Bit Holder



The Taper Lock is the first bit holder that really works! The harder you pull, the tighter it gets! It also features a one touch auto lock for easy release of the bit with one hand. It works with any bit.

FC.TLHB One Hand Operation \$13.31

Driver Bits

Examples Are Not Scaled to Size

SKU	Description	Price per Each	
		Each	10-ct
Magnetic			
10.440	3" Magnetic Bit Holder	\$6.64	\$5.65
Phillips			
10.440.11	1" #1 Phillips	\$0.65	\$0.49
10.440.22	2" #2 Phillips	\$0.79	\$0.18
10.440.62	6" #2 Phillips	\$1.49	\$1.24
10.440.12	1" #2 Phillips	\$0.69	\$0.49
Square			
11.440.31	2 3/4" #1 Square	\$0.79	\$0.69
11.440.12	1" #2 Square	\$0.69	\$0.19
11.440.22	2" #2 Square	\$0.89	\$0.29
11.440.32	3" #2 Square	\$0.99	\$0.59
Hardened Tip Driver Bits			
11.440R.42	4" #2 Square	\$2.09	\$1.99
11.440R.62	6" #2 Square	\$1.99	\$1.49
Combo			
111.440.12	1" #2 Combo	\$0.59	\$0.49
111.440.22	2" #2 Combo	\$0.85	\$0.72
Pozi			
114.440.12	1" #2 Pozi Drive	\$1.19	\$0.89
114.440.22	2" #2 Pozi Drive	\$0.99	\$0.79
114.440.23	2" #3 Pozi Drive	\$0.79	\$0.59
Allen			
113.440.4	1 3/16" 4 mm Allen	\$1.49	\$1.29
113.440.5	1 3/16" 5mm Allen	\$1.39	\$0.19
113.440.6	1 3/16" 6mm Allen	\$1.29	\$0.99
Torx			
13.440.120	1" 20mm, 1/4" Hex Shank	Each \$0.80	60-ct \$0.63
13.440.220	1 15/16" 20mm, 1/4" Hex Shank	Each \$1.98	20-ct \$1.78

Senco Staples and Nails

18 Gauge Brads

Brad Nails, AX Series

SKU	Length	Qty	Price
SN.NAX10EAA	5/8"	5,000	\$17.52
SN.NAX11EAA	3/4"	5,000	\$19.00
SN.NAX13EAA	1"	5,000	\$20.60
SN.NAX15EAA	1 1/4"	5,000	\$23.45
SN.NAX17EAA	1 1/2"	5,000	\$27.22
SN.NAX18EAA	1 5/8"	5,000	\$28.29
SN.NAX19EAA	1 3/4"	5,000	\$29.39
SN.NAX21EAA	2"	5,000	\$31.82

Headless Pins

SKU	Length	Qty	Price
SN.NAZ08EAA	1/2"	5,000	\$30.18
SN.NAZ11EAA	3/4"	5,000	\$37.06
SN.NAZ13EAA	1"	5,000	\$40.16

Slight Head Brads, AY Series

SKU	Length	Qty	Price
SN.NAY10EAA	5/8"	5,000	\$35.56
SN.NAY11EAA	3/4"	5,000	\$37.06
SN.NAY13EAA	1"	5,000	\$40.83

18 Gauge 1/4" Crown Staples

Applications: cabinets, soffits, drawer assembly. Features durable metal cylinder, reload indicator, and ultra-lightweight design. Includes wrenches, no-mar pad, case, and plug. Also includes a five-year warranty.

Compatible Fasteners

- Type: 18 Gauge 1/4" Crown Medium Wire Staples
- Gauge: 18
- Range: 3/8" - 1-1/2"
- Collation: Glued

Compatible with SN.TSNS200XP*

SKU	Length	Qty	Price
SN.SL06BAB	3/8"	10,000	\$29.19
SN.SL08BAB	1/2"	10,000	\$34.36
SN.SL10BABN	5/8"	5,000	\$19.86
SN.SL11BRB	3/4"	5,000	\$18.27
SN.SL12BAB	7/8"	5,000	\$25.16
SN.SL13BRBN	1"	5,000	\$23.45
SN.SL14BRB	1 1/8"	5,000	\$26.74
SN.SL15BRB	1 1/4"	5,000	\$29.81
SN.SL17BAB	1 1/2"	5,000	\$37.56

16 Gauge Finish Nails, Straight, T-Head

Compatible with SN.TFP32*

SKU	Length	Qty	Price
SN.NM001001	1"	2,000	\$11.05
SN.NM001002	1 1/4"	2,000	\$11.92
SN.NM001003	1 1/2"	2,000	\$12.79
SN.NM001005	2"	2,000	\$14.54
SN.NM001007	2 1/2"	2,000	\$16.01

15 Gauge Finish Nails, DA Series

Compatible with SN.TFP42XP

SKU	Length	Qty	Price
SN.NDA13EPBN	1"	4,000	\$45.34
SN.NDA15EPBN	1 1/4"	4,000	\$47.92
SN.NDA17EPBN	1 1/2"	4,000	\$49.80
SN.NDA19EPBN	1 3/4"	4,000	\$53.80
SN.NDA21EPBN	2"	4,000	\$56.00
SN.NDA23EPBN	2 1/4"	4,000	\$58.75
SN.NDA25EPB	2 1/2"	3,000	\$48.27

23 Gauge Brads Headless Pins, CZ Series

SKU	Length	Qty	Price
SN.NA100509**	1/2"	2,600	\$12.28
SN.NCZ08EAA	1/2"	15,500	\$16.85
SN.NA100629**	5/8"	2,600	\$12.73
SN.NCZ10EAA	5/8"	15,500	\$17.96
SN.NA100759**	3/4"	2,600	\$13.27
SN.NCZ11EAA	3/4"	15,500	\$19.76
SN.NA101009**	1"	2,600	\$14.15

Compatible with SN.TFP235XP*

*Fits most brands of nailers including: Accuset, Atro, Craftsman, DeWalt, DuoFast, Fasco, Hitachi, Makita, Porter Cable, and Spotnails.

16 Gauge 7/16" Crown Staples

Compatible with SN.TSNS200XP*

SKU	Length	Qty	Price
SN.SN10BAB	5/8"	5,000	\$46.22
SN.SN13BAB	1"	5,000	\$45.65
SN.SN15BRB	1 1/4"	10,000	\$96.26
SN.SN16BRB	1 3/8"	10,000	\$110.02
SN.SN17BRB	1 1/2"	10,000	\$96.53
SN.SN19BRB	1 3/4"	10,000	\$111.12
SN.SN21BRB	2"	10,000	\$125.98

*Fits most brands of staplers including: Accuset, Atro, DeWalt, DuoFast, Fasco, Hitachi, Porter Cable, and Spotnails.

Furniture Hardware

Casters

Heavy Duty Casters, Non-Marking

Polypropylene, 3" Caster
OA Height: 3 3/4"; Wheel: 3" x 1 1/4"; Plate: 4 1/8" x 3 1/8"

SKU	Style	Capacity p/Wheel	Price per Each	
			Each	10-ct
57.25829	3" Rigid	210 lbs	\$3.89	\$3.49

Polypropylene, 3" Caster
OA Height: 3 3/4"; Wheel: 3" x 1 1/4"; Plate: 2 1/2" x 4 7/8"

SKU	Style	Capacity p/Wheel	Price per Each	
			Each	10-ct
57.25189	3" Swivel	210 lbs	\$7.62	\$7.04

Inner: Nylon (Black), Outer: Polyanel (Gray) 3" Caster (No Brake)
OA Height: 3 7/8"; Wheel: 3" x 7/8"; Plate: 2 3/8" x 2 3/8"

SKU	Style	Capacity p/Wheel	Price per Each	
			Each	10-ct
57.75123.18	3" Swivel	110 lbs	\$6.48	\$5.41

Inner: Nylon (Black), Outer: Polyanel (Gray) 3" Caster w/Brake
OA Height: 3 7/8"; Wheel: 3" x 7/8"; Plate: 2 3/8" x 2 3/8"

SKU	Style	Capacity p/Wheel	Price per Each	
			Each	10-ct
57.75123B.18	3" Swivel Brake	110 lbs	\$6.36	\$5.30

2" Twin Casters

Hooded Twin Wheel Casters w/Plate and Stem
OA Height: 2.67"; Plate: 1 1/2" x 1 1/2"

SKU	Description	Color	Cap p/Wheel	Price per Each	
				Each	100-ct
57.1525	Twin Wheel w/Plate & Stem	Black	88 lbs	\$2.31	\$1.93

Twin Casters, Chrome Plate & Stem w/Brake
OA Height: 2 1/2"

SKU	Description	Color	Cap p/Wheel	Price per Each	
				Each	100-ct
57.1542B.02	Plate & Brake	Chrome	88 lbs	\$1.53	\$1.39

Twin Casters w/Brake
OA Height: 2 1/2"; Plate: 1 1/2" x 1 1/2"

SKU	Description	Color	Cap p/Wheel	Price per Each	
				Each	200-ct
57.1542B.08	Plate & Brake	Black	88 lbs	\$1.30	\$1.083

Twin Casters (No Brake)
OA Height: 2 1/2"; Plate: 1 1/2" x 1 1/2"

SKU	Description	Color	Cap p/Wheel	Price per Each	
				Each	100-ct
57.1542.08	Plate	Black	88 lbs	\$1.44	\$1.21

Twin Wheel Casters (No Brake); Fits 3/4" Board
OA Height: 2 1/2" to the bottom of U-Bracket

SKU	Description	Color	Cap p/Wheel	Price per Each	
				Each	100-ct
57.1544.08	3/4" U Channel	Black	88 lbs	\$1.45	\$1.35

Twin Wheel Casters w/Brake; Fits 3/4" Board
OA Height: 2 1/2" to the bottom of U-Bracket

SKU	Description	Color	Cap p/Wheel	Price per Each	
				Each	100-ct
57.1544B.08	3/4" U Channel & Brake	Black	88 lbs	\$1.65	\$1.50

3/16" Inside Diameter Metal Socket for Caster Stem

SKU	Price per Each	
	Each	100-ct
57.MCS-100	\$0.38	\$0.32

Black Hooded Twin Casters w/Brake; 100 Lb. Capacity Per Wheel
OA Height: 2 1/4" to the bottom of Stem
Uses Socket: 57.MCS-100

SKU	Price per Each	
	Each	100-ct
57.5000010B.08	\$1.11	\$0.99

Black Hooded Twin Casters (No Brake)
OA Height: 2 1/4" to the bottom of Stem
Uses Socket: 57.MCS-100

SKU	Cap p/Wheel	Price per Each	
		Each	100-ct
57.5000010.08	100 lbs	\$1.48	\$1.25

Leg Levelers

Adjustable Cabinet Legs

Steel Fastening Screw w/
White Plastic Cap

Top Leg Bracket

Connecting Clip

Adjustable Base

Glide

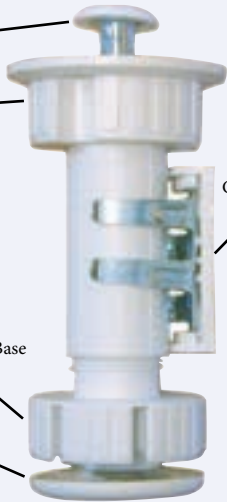

Leg Leveler Kit Includes:

- Screw
- Top Leg Bracket
- 4" Leg
- Base
- Guide
- Choose Connecting Clip

SKU	Description	Price per Each	
		Each	100-ct
36.410	Leg Leveler Kit	\$2.46	\$2.28
36.4175	Connecting Clip (Screw-on)	\$0.56	\$0.46

250 lbs. per leg

3/4" adjustment form 4" to 4 3/4"

Cabinet Levelers

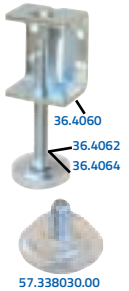

SKU	Description	Case Qty	Price per Each	
			Each	Case
36.3816.02	3/8"-16 x 2", Zinc	500	\$1.09	\$0.95
36.4060.02	U-Bracket	100	\$1.05	\$0.86
36.4062.02	Stem 2" x 8mm	500	\$0.45	\$0.40
36.4064.02	Stem 2 3/4" x 8mm	500	\$0.47	\$0.3820
57.335340.08	5/16"-18 x 1", Black	2,000	\$0.23	\$0.19
57.338030.00	1/4"-20 x 1", Clear	2,000	\$0.23	\$0.23

Applicable with T-Nuts

T-Nuts

SKU	Size	Prongs	Case Qty	Price per Each	
				100-ct	Case
36.4088.02	1/4"-20 x 3/16H	3	5,000	\$0.0851	\$0.0635
36.4089.02	5/16"-18 x 3/8H	4	2,500	\$0.1050	\$0.765
36.516.02	5/16"-18 x 5/8H	3	2,500	\$0.1596	\$0.1162
36.4091.02	3/8"-16 x 7/16H	4	2,000	\$0.1307	\$0.0951
36.4090.02	8 mm	4	2,500	\$0.1291	\$0.0940

Tack Glides (for Chair & Furniture Feet)

SKU	Size	Height	Price per Each	
			100-ct	1,000-ct
57.109*	5/8"	1/4"	\$0.05	\$0.05
57.01*	5/8"	1/4"	\$0.04	\$0.03
57.10934.01	3/4"	1/4"	\$0.07	\$0.06
57.01.03.04	1/2"	3/8"	\$0.08	\$0.08
57.01.04.04	5/8"	3/8"	\$0.08	\$0.695
57.01.05.04	3/4"	3/8"	\$0.06	\$0.05
57.332019.07	1 3/4" x 5/8"	1/4"	\$0.13	\$0.10
57.336200.08	3/4"	1/4"	\$0.09	\$0.07
57.339300.08	1 1/15" x 7/8"	5/16"	\$0.18	\$0.14
57.RD.75	3/4"	1/4"	\$0.07	\$0.06
57.RD.75T	3/4"	3/8"	\$0.09	\$0.06
57.7114.12	7/8"	1/4"	\$0.44	\$0.37
57.7118.07	1"	1/4"	\$0.44	\$0.37

Grommets

Grommets and Caps

SKU	Size Bore	Finish	Price per Each	
			Each	100-ct
Grommets				
77.2670.08	60mm, Flexible	Black	\$1.77	\$1.44
77.2670.01	60mm, Flexible	White	\$1.77	\$1.44
77.2670.10	60mm, Flexible	Beige	\$1.77	\$1.44
77.2870.08	80mm, Flexible	Black	\$2.08	\$1.69
77.2871.01	80mm, Flexible	White	\$2.08	\$1.69
77.2872.07	80mm, Flexible	Brown	\$2.53	\$2.06
77.511.07	1 3/4" Diameters	Brown	\$0.65	\$0.53
77.511.08	1 3/4" Diameters	Black	\$0.65	\$0.53
77.513.07	2 1/2" Diameters	Brown	\$0.99	\$0.82
77.513.08	2 1/2" Diameters	Black	\$0.99	\$0.82
77.553.08	6" Diameters	Black	\$3.59	\$2.99
Use Cap #s: 77.510.06, 77.510.07 and 77.510.08				
Use Cap #: 77.512.08				
Caps				
77.51.08	1 1/8" Diameters	Black	\$0.09	\$0.07
77.510.06	1 1/2" Diameters	Pol Brass	\$0.90	\$0.74
77.510.07	1 1/2" Diameters	Brown	\$0.65	\$0.53
77.510.08	1 1/2" Diameters	Black	\$0.65	\$0.53
77.512.08	2 3/8" Diameters	Black	\$1.06	\$0.90
1 1/2" caps are used with 1 3/4" grommets				
2 3/8" caps are used with 2 1/2" grommets				
Cap & Grommet				
77.600.08	60mm x 118mm	Black	\$2.53	\$2.06
77.650.01	50mm, 1.968"	White	\$1.41	\$1.15
77.650.08	50mm, 1.968"	Black	\$1.41	\$1.15
77.650.07	50mm, 1.968"	Brown	\$1.41	\$1.15
77.650.12	50mm, 1.968"	Almond	\$1.41	\$1.15
77.650.18	50mm, 1.968"	Gray	\$1.41	\$1.15
77.660.01	60mm, 2.362"	White	\$1.66	\$1.35
77.660.08	60mm, 2.362"	Black	\$1.66	\$1.35
77.660.07	60mm, 2.362"	Brown	\$1.66	\$1.35
77.680.08	80mm, 3.150"	Black	\$1.88	\$1.88
77.680.01	80mm, 3.150"	White	\$1.88	\$1.53

FastCap™ Dually Grommet™ (Dual-Sided Grommet)

FastCap's new Dually Grommet is what cabinetmakers have been asking for! The Dually Grommet is a dual-sided interference locking grommet that finishes both sides of your hole in a snap! Works with depths from 3/4" to 2 1/2".



SKU	Color	Each
FC.DUALY2.5SINGLEAL	Almond	\$4.00
FC.DUALY2.5SINGLEBL	Black	\$4.00
FC.DUALY2.5SINGLEHR	Hardrock	\$3.63
FC.DUALY2.5SINGLEWH	White	\$4.00

- Finished look on both sides
- No gluing
- Fully paintable

Glass Doors/Mirror/Panel Hardware

Mirror & Panel Retainers

Recommended Screw: #0.PPCC06...

SKU	Description	Color	Offset	100-ct	1,000-ct
62.01.12.00	Mirror clip	Clear	3/32"	\$0.57	\$0.011
62.01.25.00	Mirror clip	Clear	9/32"	\$0.0562	\$0.0511
SKU	Description	Color	Offset	100-ct	1,000-ct
62.02.03.00	Panel clip	Clear	1/32"	\$0.07	\$0.06
62.02.12.00	Panel clip	Clear	3/32"	\$0.07	\$0.06
62.02.25.00	Panel clip	Clear	9/32"	\$0.07	\$0.06
62.02.31.00	Panel clip	Clear	1 1/32"	\$0.70	\$0.06
SKU	Description	Color	Offset	100-ct	1,000-ct
62.04.03.00	Panel clip	Clear	1/32"	\$0.06	\$0.05
62.04.12.00	Panel clip	Clear	1/8"	\$0.06	\$0.05
62.04.31.00	Panel clip	Clear	5/16"	\$0.06	\$0.05
62.21-291.187	Panel clip	Brown	3/16"	\$0.04	\$0.0295

Glass Retaining Bracket

SKU	Color	100-ct	1,000-ct
62.05.05	Statutory Bronze	\$0.05	\$0.42

Includes Mounting Screw

1/4" Glass Door Pivot Hinges

- Glass Door Length: 1 37/64" (40mm) x Width 45/64" (18mm) x Thick 7/16" (11mm). From the Pivot to the Edge of the Hinge is 13/64" (5mm). Hole For Grommet is Just Under 3/8".

SKU	Color	Price per Each Pair	
		Pair	100 Pairs
54.25.02	Chrome	\$2.31	\$2.10
54.25.06	Brass	\$2.31	\$2.10
54.25.08	Black	\$2.60	\$2.1667

Slip-On Glass Door Catch

SKU	Color	Price per Each	
		Each	100 Pairs
54.27.02	Chrome	\$0.46	\$0.42
54.27.06	Brass	\$0.51	\$0.46
54.27.08	Black	\$0.33	\$0.30

Handle Slip-On for Magnetic Catch

SKU	Color	Price per Each	
		Each	100 Pairs
54.28.06	Brass	\$0.75	\$0.68
54.28.08	Black	\$0.62	\$0.56

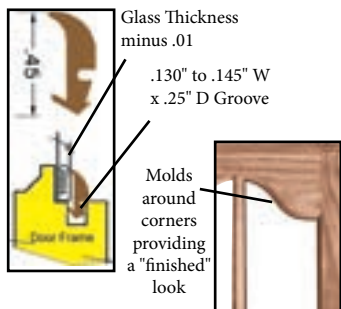

Glass or Wood Panel Moldings

- No tools required for installation
- Holds glass in place without rattling
- The soft rubber fits easily around curved door shape
- Stock Colors: Black, Clear, Brown, Off-White & Fruitwood
- 100 feet minimum order
- 1,000 feet per roll

SKU	Color	Price per Roll		
		100 Feet	1 Roll	2 Rolls
62.00.01	Off-White	\$0.260	\$0.18	\$0.1650
62.00.07	Brown	\$0.260	\$0.18	\$0.1650
62.00.08	Black	\$0.300	\$0.2200	\$0.200
62.00.99	Fruitwood	\$0.33	\$0.22	\$0.165
62.00.00	Clear	\$0.30	\$0.22	\$0.20
62.00.SAMPLE	Sample Color Chain			



Slot Cutter, Made for 62.00** Glass/Wood Panel Molding

SKU	Description	Price
900.007	1/2" Shank, 3/64" Keft, 1/4" Slot Depth; Bearing on Shank Side	\$19.99

Stool Swivels



#40.712



#40.712R.3

- BIFMA/ANSI Testing
 - Easy Installation
 - 500 lb. Weight Limit
 - Other Styles & Sizes Available
 - Recommended Screw: 0.TPC10...
- | SKU | Size | Case Qty | Price per Each | |
|-------------|------|----------|----------------|---------|
| | | | Each | Case |
| 40.712 | 7" | 17 | \$13.95 | \$12.95 |
| 40.712.3* | 7" | 16 | \$12.99 | \$10.99 |
| 40.712R.3** | 7" | 15 | \$25.63 | \$23.80 |
- *3° Tilt
** 3° Tilt, 90° Return

Glider/Rocker Hardware Set

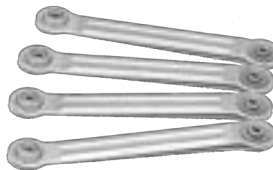

Build your own glider!
Measures 7 1/2" between centers with a 1/4" offset. Mounts with common 1/4" diameter bolts (not included).
Recommended Fasteners:
(4) KD Bolt 16.BB1420
(4) Nut 14.250.04
(8) Washer 14.250.75.04

SKU	Description	Set (4)
15.PB1473-4	Glider/Rocker Hardware Set	\$29.10

Swivel Hardware

Lazy Susan Swivels



- Cast Aluminum
- Full-round or Pie Cut (Removable Stop)
- Recommend Screws:
(Five) 0.FPC10114Z... (Outer Ring)
(Five) 0.PPC10034Z... (Inner Ring)

SKU	Size	Capacity Lbs	Each
67.841848UF8	12 7/8" Diameter	350 lbs	\$22.76

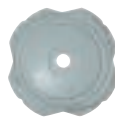

TV Lazy Susan Swivel, Ball Bearing

SKU	Size	Capacity Lbs	Price per Each	
			Case Qty	Each
40.0.4020	5"Hx10.3L"x10.3"W	500 lbs	10	\$18.63



Square, Steel Lazy Susan Swivel

SKU	Size	Capacity Lbs	Price per Each	
			Case Qty	Each
40.0.3C	3" Square	200 lbs	100	\$1.32
40.0.4C	4" Square	300 lbs	75	\$1.69
40.0.6C	6" Square	500 lbs	100	\$2.95



Round, Steel Lazy Susan Swivel

SKU	Size	Capacity Lbs	Price per Each	
			Case Qty	Each
40.0.9C	9" Diameter	750 lbs	25	\$5.45
40.0.12C	12" Diameter	1,000 lbs	25	\$9.95

Wall Beds

Save space in your home with the innovative bed hardware from Custom Service Hardware. We carry a variety of do-it-yourself bed hardware kits (including hardware from Murphy Wall-Beds Hardware Inc.) for queen size beds, full size beds, and twin beds.

Wall Bed System Hardware Kits

- Instructions Included for Construction.
- Two-Year Manufacturers Limited Warrantee.
- Patented, Reliable, Safe, Spring-Powered Counter Balance.

Exposed Horizontal Application Shown (Wall Unit Not Included).

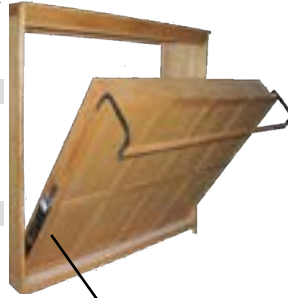

Exposed Hardware



Single/Twin Bed, Vertical

SKU	Description	Load Cap	Price
54.XSMV03950I	Concealed Vertical	110 lbs	\$399.99
54.XSMV03950X	Exposed Vertical	110 lbs	\$425.00

Double Bed, Vertical

SKU	Description	Load Cap	Price
54.XSMV05475I	Concealed Vertical	165 lbs	\$493.00
54.XSMV05475X	Exposed Vertical	165 lbs	\$493.00

Queen Bed, Vertical

SKU	Description	Load Cap	Price
54.XSMV05475X	Concealed Vertical	243 lbs	\$493.00
54.XSMV054110X	Exposed Vertical	243 lbs	\$515.40

Single/Twin Bed, Horizontal

SKU	Description	Load Cap	Price
54.XSMH090	Exposed Horizontal	110 lbs	\$399.99

Double/Queen, Horizontal

SKU	Description	Load Cap	Price
54.XSMH0140	Exposed Horizontal	180 lbs	\$465.00

Set Contains:

- (R) & (L) Counter Balance Mechanism
- (R) & (L) Dual Purpose Leg
- (Two Each) Pivot Mount Plates
- Hardware & Fasteners for Component



End Opening Application Shown (Wall Unit and Wood Platform Not Included).



Storage Bed Lift Mechanism, Gas Spring Assisted*

Includes: (2) Lift mechanisms (each fully assembled into a one-piece unit for easy installation).

Features: Twin gas pistons for easy-open and soft-close.

Needs: A 6"-10" thick standard inner-spring/foam mattress.

SKU	Opening	Lift Force	Price
Single Bed, 3' Long Arm			
54.X2240140	Side/End	88 lbs	\$76.37
54.X2240150	Side/End	110 lbs	\$97.65
54.X224015	Side/End	165 lbs	\$97.65
Double Bed, 4' Long Arm			
54.X224005	Foot End	209 lbs	\$109.99
Queen Bed, 5' Long Arm			
54.X224025	Foot End	239 lbs	\$110.00



Storage Bed Lift Kits*

The storage bed lift kit is designed to provide easy access to a great storage area. With a single hand, anyone can lift the platform to reveal vast amounts of storage, all visible and easily accessible. The gas pistons make it easy to lift open and slow down the close for safety.

Set Contains:

- Gas Spring Assisted Lift Mechanism
- Steel Bed Frame (Black Powder Coated)
- Curved Beech Wood Slats

SKU	Opening	Lift Force	Price
Single Bed, 39" x 75"			
54.X8001	Side	88 lbs	\$242.19
54.X8003	Foot End	88 lbs	\$279.65
Double Bed, 54" x 75"			
54.X8005	Foot End	143 lbs	\$315.26
Queen Bed, 60" x 80"			
54.X8007	Foot End	154 lbs	\$310.90

*Designed to be used without a box spring.

MURPHY® WALL-BEDS HARDWARE INC.



Murphy Panel Bed* - 25 year Warranty

Set Contains:

- (1) Mechanism
- (1) Frame w/ Regular Leg

Supreme Steel System

Recommended for residential use and raised panel design. These 16 gauge steel systems are finished in an attractive black pebble powder coat and guaranteed to support 1,700 lbs of weight. Stiffener design runs horizontally for full face panel support.

Mattress, Wall Unit & Accessories Not Included

The Panel Bed requires you to build the bed Cabinetry to mount the hardware. Sold as a hardware kit only. Call for specs.

SKU	Description	Mattress Size & Max Thickness	Price
MB.SBFMSBFS	Single/Twin Vertical Supreme	39"W x 75"L x 10 1/2"H	\$895.72
MB.SBFMSBFD	Double/Full Vertical Supreme	54"W x 75"L x 10"H	\$970.07
MB.SBFMSBFQ	Queen Vertical Supreme	60"W x 80"L x 10"H	\$989.54
MB.STSBFMSTSBFS	Single/Twin Side Tilt Supreme	39"W x 75"L x 10"H	\$1,194.00
MB.STSBFMSTSBFD	Double/Full Side Tilt Supreme	54"W x 75"L x 10 1/2"H	\$1,224.00
MB.STSBFMSTSBFQ	Queen Side Tilt Supreme	60"W x 80"L x 10 1/2"H	\$1,252.00

*The Freight cost is included in the published price when shipped in the continental U.S.

Bed Hardware

Bed Brackets

Interlocking Brackets w/Safety Lock Screw Hole



Recommended Screw: 0.FPC08...

Determine length by use. Sold as sets (eight pieces per set).

Price per Each

SKU	Size	Each	80-ct
15.004	3 3/4"	\$3.19	\$2.89
15.013	5 3/4"	\$4.59	\$4.19

Single Bedlock Mounting Plate

1 3/4" Overall Width
3/8" Groove needed in the post to mount

Price per Each

SKU	Height	Each	48-ct
15.BL3755.07	3 3/4"	\$1.99	\$1.79

Bed Rail Slot Bracket

Fits into bed post slot or bracket.
Overall Width: 2 1/4"
Overall Height 3 1/2"
Slot Width for Pin: 5/16"
Mounting holes (bed rail): 2"cc, 5/16" diameter

Price per Each

SKU	Each	50-ct
15.BDF-10	\$0.79	\$0.63

Bed Pin



Bed Pins

Price per Each

SKU	Size	Each	100-ct
15.BP.125	1 1/4" L x 5/16" Dia.	\$0.094	\$0.069
15.BP.200	2" L x 5/16" Dia.	\$0.14	\$0.11

Bed Rail Fasteners



Heavy Duty Bed Rail Fasteners

.125 Gauge Steel, Rigid Assembly, Quick Disconnect, Rounded Corners. (Four pairs per set)

Price per Set

SKU	Size	Per Set	25-Set
15.74.5	5/8" W x 4 1/16" L	\$6.03	\$5.03

Bed Slat Hardware

- **Secure:** Tested at more than 400 lbs each.
- **Concealed:** Reveals more of the headboard
- **Effortless:** Quick & easy assembly/disassembly
- **Ergonomic:** Minimum space, lowest boxspring/mattress placement
- **Durable:** No more loose bed slats
- **Inexpensive:** Pay as low as \$3.00 per bed

SKU	Description	Size	Price per Each		
			Each	200-ct	2,000-ct
15.07.00	Bed Slat Bracket, Plain	1 3/8"W x 2 3/8"H x 1"D	\$0.57	\$0.43	\$0.34
15.07.08	Bed Slat Bracket, Black	1 3/8"W x 2 3/8"H x 1"D	\$0.87	\$0.65	\$0.52

Recommended Screw: [0.FPC08...](#)

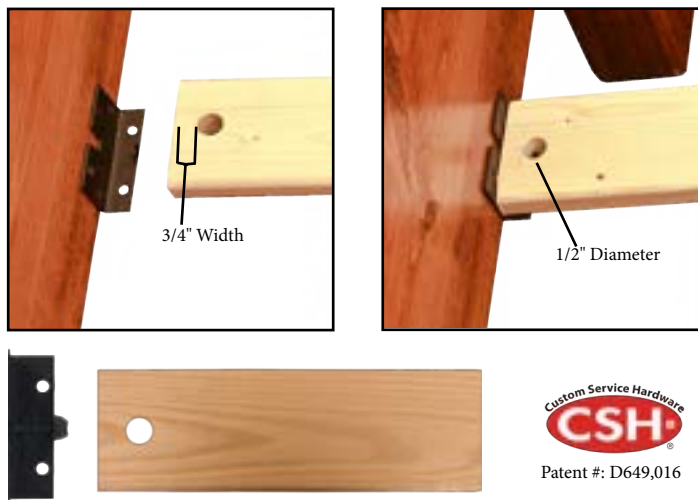

Patent #: D649,016

Bed Frame Hardware

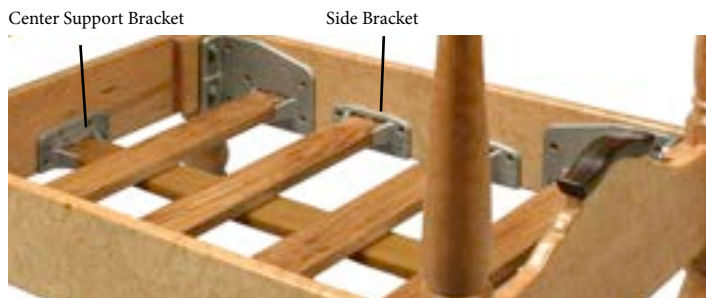

Mounting Kits

Standard Bed Type



Lead content in the aluminum is less than 100ppm.

[LM.FS074](#) \$42.79

Sleigh, Mission, Shaker Bed Type



[LM.SS084](#) \$44.99

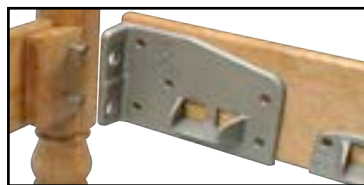

The Corner bracket extends up 4 11/16" from the bottom edge of the side rails.



Sleigh, Mission, Shaker Bed Type

Additional Brackets (Center Support & Side Brackets)



Lead content in the aluminum is less than 100ppm.

Recommended Screw: (Four) [0.FCC10100P...](#)

[LM.HFD12](#) Center Support Bracket \$5.56



Recommended Screw: (Three) [0.FCC10100P...](#)

[LM.SMALLBKT-A356](#) Side Bracket \$4.12

Bed Frame Hardware Screw Pack

Installation Screw Pack Includes (32) [0.FCC10100P](#) & (32) [16.5169.150](#)

SKU	Each
LM.SCREWPACK	\$3.99



Bunk Bed Ladder Hook

Black, 3 1/2" High x 1 3/4" Width x 1/2" Depth (1 1/2" inside width)

Recommended Screw: [0.FSC08B...](#)

Sold Individually

SKU	Price per Each		
	Each	500	1,000
15.110.08	\$2.31	\$1.5429	\$1.2624



Dovetail Brackets, Set of 8

- Set of 8 brackets
- Black finish
- For bed support slats
- Slats and fasteners sold separately

[CM.DTB](#) \$15.99

Recommended Screw: [0.PPC08...](#) or [0.RWC08...](#)

Bed Brackets, Set of 4

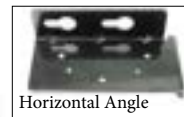

Horizontal Angle

- Set of 4 brackets
- Black finish
- Includes lip to easily align with bed rail
- Fasteners sold separately

[CM.DA5](#) \$13.99

Recommended Screw: [0.PPC08...](#) or [0.RWC08...](#)

Table Hardware



Wood Reciprocation Table Slide

Opening/closing one end automatically opens or closes the opposite end in an equal amount, making it possible for one person to operate. Available for pedestal or 4-legged tables.

SKU	Length	Type	Per Pair
15.84.26	26"	Pedestal	\$72.33
15.91.50	50"	Pedestal	\$135.27
15.84.26-L	26"	4-legged	\$71.39
15.91.50-L	50"	4-legged	\$92.73



Table Not Included

Spring Assisted Lift-Top Table Mechanism, 100 Lb. Load Capacity

Tubular Steel Construction w/Over-baked Epoxy Coating. Table Top should Over-Hang the Base for Easy Lifting. Closed Dimensions: 23.5" L x 19.5" W x 3.44" H

54.XPE287 Raises 8 1/4" \$203.02

Table Pin/Socket Set w/Spira-Barb Threads

15.0732-PS 3/4" x 5/16"; 305 Drill Size \$0.65

Table Pin w/ Spira-Barb Threads

15.0745-PO 3/8" x 1 1/4" \$0.71

Table Leg Corner Brace, 16 Gauge, Unfinished

SKU	Description	Price per Each		
		Each	500	1,000
15.A41	2" x 3 1/4"	\$0.20	\$0.15	\$0.12

Table Leg Corner Brace

SKU	Description	Price per Each		
		Each	500	1,000
15.A95	2 1/2" x 5 1/4"	\$1.03	\$0.83	\$0.69

OAL Steel Lever Lock

15.TL516	16" OAL	\$9.69
15.TL526	26" OAL	\$11.03

Desk & Counter Top Fastener

SKU	Description	Price per Each		
		Each	500	1,000
15.DTF.00	1/8" Thick	\$0.31	\$0.26	\$0.21

Recommended Screws: (Two) 0.PPC08*

*Length Varies with Application

.75" x 1.31" Table Top Fastener, .38" Offset

SKU	Price per Each		
	Each	500	1,000
15.75Z	\$0.14	\$0.1196	\$0.1025

Recommended Screws: (One) 0.PPC08...*

2" Leaf Leveler, 14 Gauge

15.LL101	Plain Steel	\$0.20
----------	-------------	--------

Align-N-Lock, Yellow Zinc

15.TL107BR \$2.88



Pullout Support, Plain Steel
Closed Length: 14 3/4"; Travels: 7 3/4"
15.P0139 \$3.95



Ajusta Drop Leaf Support with Safety Ring, Apron Mount

15.DL108ABR01	Yellow Zinc, 8"	\$5.02
15.DL110ABR01	Yellow Zinc, 10"	\$5.64
15.DL112ABR01	Yellow Zinc, 12"	\$6.00

Ajusta Drop Leaf Support with Safety Ring, Surface Mount

15.DL208ABR01	Yellow Zinc, 8"	\$6.62
15.DL210ABR01	Yellow Zinc, 10"	\$7.20
15.DL212ABR01	Yellow Zinc, 12"	\$7.54

Matte Black Indoor/Outdoor Cast Iron Table Bases

- Steel Tube w/ Cast Iron Base and Spider Attachment
- 3" Diameter Steel Tube
- Black Matte Finish
- For indoor or outdoor use

End Style X
Size: 5" x 22"

PM.2001-28-MT	28" H	\$39.89
PM.2001-40-MT	40" H	\$64.38

Style X
Size: 22" x 22"

PM.2022-28-MT	28" H	\$66.29
PM.2022-40-MT	40" H	\$70.99

Size: 30" x 30"

PM.2030-28-MT	28" H	\$68.78
PM.2030-40-MT	40" H	\$71.32

Office & Media Storage

Hanging File Drawer Bars & Brackets

Aluminum File Bars are easy to cut
Available in 1/2" & 3/4" Height x 1/8" Thick

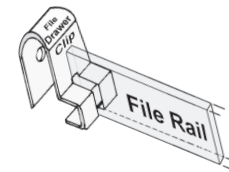

Steel: 1/8" x 1/2" x Length

Steel File Bars, Zinc Finish, 1/8" Thick

SKU	Length	Price per Each		
		Each	100-ct	500-ct
15.F-75.12.04	12"	\$2.05	\$1.74	
15.F-75.2214.04	22 1/4"	\$2.98	\$2.23	\$1.79
15.F-75.24.04	24"	\$3.33	\$2.49	\$2.00

Aluminum File Bars, Mill Finish, 1/8" Thick

SKU	Length	Price per Each		
		Each	100-ct	500-ct
15.F-50.48.AL	1/2" x 48"	\$6.12	\$5.68	\$5.25
15.F-75.48.AL	3/4" x 48"	\$4.66	\$3.49	\$2.79

Clips

SKU	Length	Price per Each		
		Each	100-ct	500-ct
15.D-216.04	1/2" W	\$0.69	\$0.55	\$0.46



File Drawer Bar Clip

Hanging File Drawer File Rail & Clips

SKU	Description	Size	Case Qty	Price per Each	
				Each	Case
CA.32548	File Rail	1/2" x 4'	100	\$4.50	\$4.10
CA.900K	File Rail Clip		1,000	\$0.36	\$0.33



Pencil Tray without Lock

Includes brackets and screws for under mounting. 10 1/2" W x 19 1/4" D x 2" H

SKU	Case Qty	Price per Each	
		Each	Case
CA.89777	10	\$29.99	\$26.99

Keyboard Slide, 3/4" Extension Ball Bearing, 50 lb. Capacity

Side Clearance: 1 1/16" Inboard Position,
1 1/2" Outboard Position.
Recommended Screw: 0.TPC08...



SKU	Size	Case Qty	Price per Set		
			Set	Case	10-Case
39.1160.16.08	16"	20	\$13.79	\$11.04	\$7.90
39.1160.18.08	18"	20	\$12.77	\$10.22	\$8.53

REV-A-SHELF



Knockdown File Folder Kit

- Use in Standard Height Base 18 Drawer/Door Cabinet
- Minimum Opening: 14 1/2" W x 20 1/2" H
- Bottom, Side and Rear Mounting for Complete Stability
- Two-Tier File Drawer system
- Optional Door Mount Kit Sold Separately

SKU	Description	Each
R.RAS.FD.KIT	Chrome Wire	\$106.23

Door Mounting Kit for File Drawer

- Adjustable to accommodate almost any door style
- Patented Door Mount Kit can be used on any RV series waste container
- Includes: complete set of brackets, fasteners and spacers for installation on any door style

R.RV.DM.FDKIT	White	\$36.60
---------------	-------	---------



Cabinet & Mailbox Locks

Cabinet Locks



REV-A-LOCK®

These powerful magnetic locks can attach to wood, glass, metal, and particleboard. Simply hold the magnetic key against the cabinet door to disengage the lock. The lock is invisible on the outside of the cabinet which is perfect to keep valuables locked away or to keep children out of cabinets.

SKU	Description	Price
R.RL.201.1	Lock Assembly	\$7.69
R.RL.202.1	Magnetic Key	\$10.34
R.RAL.101.1	Starter Set (Five Locks and Two Keys)	\$45.20

CompX® Regulator Keyless (Push Button) Cabinet Lock

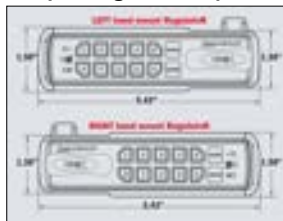

The Regulator is available in two versions: self-locking and manual locking. Self-locking features SlamCam, a spring-loaded latch, which allows the user simply to close the cabinet door or drawer with no need to return the knob to the locked position. The manual locking version, which uses existing CompX National cams, requires users to rotate the knob into the unlocked and locked positions. The Regulator is easy to install, use and maintain!

SKU	Type	Mounting Style	Price
CX.REG-S-R-3	Self Lock	Horizontal Right Mount	\$107.17
CX.REG-M-L-3	Manual Lock	Horizontal Left Mount	\$99.95
CX.REG-M-R-3	Manual Lock	Horizontal Right Mount	\$99.95

Removable Core Lock System



- Keyed alike or keyed differently
- Cores remove easily for maintenance and security
- 3/4" diameter, 7/8" barrel length
- Up to 30 different key combinations possible
- Available in Nickel, Black and Brass
- **Cores sold separately**

SKU	Description	Finish	Case Qty	Price per Each	
				Each	Case
UF.607.02	Cam Lock Cylinder Housing	Nickel	20	\$2.60	\$2.17
UF.607.06	Cam Lock Housing	Brass	20	\$2.68	\$2.24
UF.607.08	Cam Lock Housing	Black	20	\$2.79	\$2.33
UF.608.02*	Drawer Lock Round Cylinder Housing	Nickel	25	\$2.55	\$2.13
UF.608.06	Drawer Lock Round	Brass	25	\$2.55	\$2.13
UF.608.08	Drawer Lock Round	Black	25	\$2.62	\$2.19
UF.628.02*	Double Drawer Lock Cylinder Housing	Nickel	20	\$4.47	\$3.73
UF.CORE**.02	Core with Two Keys	Nickel	50	\$2.93	\$2.25
UF.CORE**.06	Core with Two Keys	Brass	50	\$3.14	\$2.41
UF.CORE**.08	Core with Two Keys	Black	50	\$3.05	\$2.34
UF.REDKEY	Core Removal Key	Red	100	\$1.50	\$1.40
UF.BLUEKEY	Master Key	Blue	100	\$1.89	\$1.45

*The lock housings come with the strike plate/bracket

More options available at www.cshardware.com



First Keyless, Invisible Cabinet Locking System

The Stealth Lock is easy to install and can replace your existing cabinet locks!

The radio frequency technology permits the Transmitter Pad to be stored anywhere, leaving no trace of visible hardware or signs of being secured.

Features & Functions

- One Transmitter Pad can activate an unlimited number of Receiver Latches
- Transmitter Pad operates within a 15 ft. range
- Separate user and supervisor codes (four to eight digits) to operate the lock(s)
- Receiver Latch is easily programmed by user through the Transmitter Pad
- Receiver Latch mounts within a 1/2" drawer suspension clearance
- Uses readily available batteries: Four AAA (not included) for the Receiver Latch and a CR2032 coin battery (included) for the Transmitter Pad
- Low battery indicator on Transmitter Pad & Receiver Latch

Applications

- Healthcare Cabinetry
- Lockers
- Kitchen Cabinets
- Office Furniture
- Entertainment Units
- Closet Cabinets
- Storage Space
- Liquor Cabinets
- Reception/Conference Room Furniture
- Retail Display Cabinets
- Audio/Visual Cabinets

Modes Available

- **Self-Lock Mode:** Allows the user to program the Receiver Latch to automatically re-lock after unlocking.
- **Passage/Manual Lock Mode** (factory default): User must manually lock.
- **Single Use Mode:** Allows the user to choose their code at the time of operation (recommended for shared or day use lockers/cabinets).

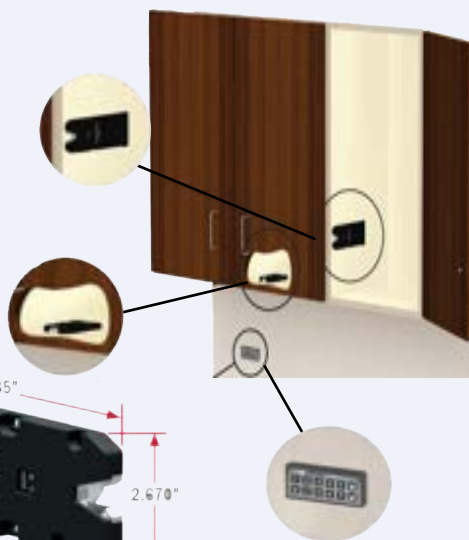

SKU	Kit Includes	Application	Price
SL.SL-100*	(1) Receiver Latch, (1) Transmitter Pad, (1) Cabinet Strike Plate, (1) Installation Tool	Contains Necessary Parts to Lock One Door or Drawer	\$154.89
SL.RL-110*	(1) Receiver Latch, (1) Cabinet Strike Plate	To Lock an Additional Door/Drawer Operated by an Existing Transmitter Pad	\$101.05
SL.TP-100	(1) Transmitter Pad	Add an Additional Transmitter Pad to your StealthLock Application	\$78.65
SL.SP-600	(1) Replacement Strike Plate		\$9.23
SL.SP-605	(1) Replacement Heavy-Duty Strike Plate		\$9.25

*To Lock a two-door system using one transmitter pad, you must purchase (1) SL.SL-100 and (1) SL.RL-110.

Optional Powering Accessories

SKU	Description	Application	Price
SL.RL-AP1	(1) Auxiliary Power Supply, (1) 5 1/2 Ft. Power Cord	Connects a Receiver Latch to 120V AC Power Supply	\$68.80
SL.RL-APC-9VJ-10	9 Volt Jump Cord (10 Ft. Cord)	Powers a Receiver Latch to a 9 Volt Battery (Not Included)	\$17.55
SL.RL-APC10	Auxiliary Power Cord (10 Ft. Cord)	Connects Additional Receiver Latch (Up to 10) to be Powered by AC Power Supply	\$12.55
SL.RL-APC3	Auxiliary Power Cord (3 Ft. Cord)	Connects Additional Receiver Latch to be powered by AC Power Supply	\$6.70
SL.RL-APC5	Auxiliary Power Cord (5 Ft. Cord)	Connects Additional Receiver Latch to be powered by AC Power Supply	\$8.13

7/8" Diameter x 7/8" Long Cabinet Lock, Chrome



Includes:
(1) Bezel
(2) Keys
Recommended Screws: **0.FPC05...**

SKU	Keyed	Price per Each	
		Each	24-ct
58.52.02	Alike	\$4.17	\$3.48

First Watch® Vintage Bronze or Polished Brass Cabinet & Drawer Lock



Requires 7/8" Mounting Hole & 3/4" Max Cabinet/Drawer Thickness.

SKU	Keyed	Finish	Each
FW.1355-VB	Different	Vin. Bronze	\$8.50
FW.1355	Different	Pol. Brass	\$8.50
FW.1355-645	Alike	Pol. Brass	\$8.50

First Watch® Cabinet & Drawer 1 1/8" Utility Cam Lock



- Keyed locking for maximum security
- Requires 3/4" Mounting Hole
- For a wood/metal door or drawer w/ max thickness of 3/4"
- (2) Washers for 90° or 180° rotation

SKU	Finish	Keyed	Each
1 1/8" Lock; 3/4" Max. Drawer Thickness			
FW.1281-601	Pol. Brass	Alike	\$9.23
FW.1385	St. Steel	Different	\$10.44
FW.1385-601	St. Steel	Alike	\$11.33
FW.1385-VB	Vin. Bronze	Different	\$11.33
FW.1385-VB-601	Vin. Bronze	Alike	\$11.33
FW.1381-601	Chrome	Alike	\$7.44
FW.1381	Chrome	Different	\$7.44
7/8" Lock; 1/2" Max. Drawer Thickness			
FW.1384-VB	Vin. Bronze	Different	\$7.20



Steel Shelf Standards

Can be surface mounted or recessed
Easy installation
Easily cut to size

SKU	Color	Length	Case Qty	Price per Each	
				Each	Case
157.48.02*	Silver	48"	100	\$1.99	\$1.65
157.72.02*	Silver	72"	100	\$3.66	\$2.96

Recommended Screw: **0.FPC04058...**

*Non-National part

Steel Shelf Clips

SKU	Color	Case Qty	Price per Each	
			Each	Case
158.02	Silver	500	\$0.15	\$0.13

Brackets & Shelf Supports

Easily and successfully install shelving in any room in your home with our shelf brackets and supports. Organize your home like never before with our easy to use shelving hardware.

Multi-Purpose Steel Brackets



SKU	Size	Each	Price per Each		
			500	1,000	
Keyhole Bracket					
15.01	1 1/4" x 1 1/4" x 6"	\$1.00	\$0.75	\$0.60	
15.08.04	1 5/8" x 3/16"	\$5.55	\$0.42	\$0.33	
Angle Bracket					
15.06.04	1 1/4" x 1 1/4" x 2"	\$0.46	\$0.36	\$0.30	
15.M2	5/8" x 3 1/2" x 3 1/2"	\$0.45	\$0.38	\$0.3250	
Ladder Hook (1 1/2" Inside Width)					
15.110.08	3 1/2" x 1 3/4" x 1/2"	\$2.19	\$1.76	\$1.33	
L Bracket					
15.044	1 3/4" x 1 3/4" x 1 3/4"	\$0.1989	\$0.1564	\$0.1270	
15.042	2" x 2" x 5/8"	\$0.28	\$0.21	\$0.17	
15.3412	3/4" x 3/4" x 1/2"	\$0.06	\$0.05	\$0.04	
15.0412	1" x 1" x 1/2"	\$0.15	\$0.11	\$0.09	
15.04	1 1/2" x 1 1/2" x 5/8"	\$0.16	\$0.13	\$0.10	
15.045	2" x 2" x 5/8"	\$0.20	\$0.17	\$0.14	

SKU	Size	Each	Price per Each		
			500	1,000	
Mending Plate					
15.05H	6" x 2 1/2"	\$1.15	\$1.03	\$1.03	
15.05	3" x 5/8"	\$0.15	\$0.12	\$0.09	
15.051	2" x 1/2"	\$0.21	\$0.16	\$0.13	
15.053	3 3/8" x 3/4"	\$0.20	\$0.1564	\$0.1270	
15.054	4" x 5/8"	\$0.28	\$0.21	\$0.17	
Mirror Supports					
15.100.16	16"	\$0.99	\$0.84	\$0.70	
Chair Leg Brace					
15.B8.05	1 1/2" x 1 1/2" x 7/8"	\$0.29	\$0.23	\$0.20	
Desk & Counter Top Fastener					
15.DTF.00*	1/8" Thick	\$0.31	\$0.26	\$0.21	

*Recommended Screws: (Two) **0.PPC08...**



Aluminum, KV 255AL Shelf Standards

SKU	Finish	Length	Case Qty	Price per Each	
				Each	Case
KV.255AL48	Aluminum	48"	100	\$1.81	\$1.65
KV.255ALBR48	Satin Brass	48"	100	\$2.62	\$2.39
KV.255ALWAL36	Walnut	36"	100	\$2.26	\$2.06
KV.255ALWAL48	Walnut	48"	100	\$3.07	\$2.80
KV.255ALBRN36	Brown	36"	100	\$2.16	\$1.98
KV.255ALBRN48	Brown	48"	100	\$2.92	\$2.66



Steel Shelf Clips, KV.256 Pilaster Clips

SKU	Color	Case Qty	Price per Each	
			Each	Case
KV.256BBR	Brass	1,000	\$0.19	\$0.17
KV.256BWAL	Walnut	1,000	\$0.17	\$0.15
KV.256BZC	Zinc	1,000	\$0.13	\$0.12



Plastic Shelf Support Strips, 5/8" W x 3/8" Thick



- Easily cut to size
- Push in shelf supports for easy adjustment
- Can be surface mounted or recessed

SKU	Color	Size	Case Qty	Price per Each	
				Each	Case
62.P18W.01	White	18" L	200	\$1.04	\$0.9455
62.P24W.01	White	24" L	200	\$1.16	\$1.0545
62.P18MB.07	Med-Brown	18" L	200	\$1.04	\$0.9455
62.P24MB.07	Med-Brown	24" L	200	\$1.16	\$1.0545
62.P18A.12	Almond	18" L	200	\$1.04	\$0.9455
62.P24A.12	Almond	24" L	200	\$1.16	\$1.0545

Recommended Screws: **0.FPC06034...**

Shelf Supports

SKU	Shank Size	Color	Price per 1,000			
			100	1,000	5,000	
H.100**	H.1004831	5mm	White	\$0.0589	\$0.0412	\$0.0343
	H.1004830	5mm	Brown	\$0.0500	\$0.0461	\$0.0375
	H.1006161	5mm	Clear	\$0.050	\$0.0461	\$0.0375
62.10**	62.10.00	1/4"	Clear	\$0.1320	\$0.1056	\$0.0882
	62.10.07	1/4"	Brown	\$0.1128	\$0.0902	\$0.0753
62.27**	62.27.02	5mm	Nickel	\$0.030	\$0.0231	\$0.0187
	62.27.06	5mm	Polished Brass	\$0.050	\$0.0461	\$0.0375
	62.27.08	5mm	Black	\$0.045	\$0.036	\$0.0328
62.29**	62.29.02	1/4"	Nickel	\$0.050	\$0.0461	\$0.0375
	62.29.03	1/4"	Antique Brass	\$0.075	\$0.065	N/A
	62.29.06	1/4"	Polished Brass	\$0.050	\$0.0461	\$0.0375
	62.29.08	1/4"	Black	\$0.0534	\$0.0428	\$0.039
62.30**	62.30.02	5mm	Nickel	\$0.0534	\$0.0428	\$0.039
	62.30.03	5mm	Antique Brass	\$0.1450	\$0.1330	\$0.1230
	62.30.05	5mm	Antique Copper	\$0.200	\$0.100	\$0.09
	62.30.06	5mm	Polished Brass	\$0.100	\$0.0923	\$0.075
62.32**	62.32.02	1/4"	Nickel	\$0.1050	\$0.09	\$0.085
	62.32.03	1/4"	Antique Brass	\$0.1250	\$0.100	\$0.09
	62.32.056	1/4"	Antique Copper	\$0.1000	\$0.99	\$0.89
	62.32.06	1/4"	Polished Brass	\$0.1000	\$0.0923	\$0.075
H.1010564	H.1010564	5mm	Nickel	\$0.3200	\$0.2894	\$0.2478
62.32V**	62.32V.05	1/4"	Antique Copper	\$0.1890	\$0.160	\$0.140

5mm Shelf Support Grommets

SKU	Shank Size	Color	Price per 1,000		
			100	1,000	5,000
62.33.02	5mm ID	Nickel	\$0.520	\$0.0438	\$0.0375
62.33.03	5mm ID	Antique Brass	\$0.0405	\$0.0375	\$0.0310
62.33.06	5mm ID	Polished Brass	\$0.039	\$0.033	\$0.030
62.33.08	5mm ID	Black	\$0.044	\$0.038	\$0.031

1/4" Shelf Support Grommets

SKU	Shank Size	Color	Price per 1,000		
			100	1,000	5,000
62.34.02	1/4" ID	Nickel	\$0.558	\$0.0465	N/A
62.34.03	1/4" ID	Antique Brass	\$0.050	\$0.033	\$0.030
62.34.06	1/4" ID	Polished Brass	\$0.490	\$0.035	\$0.032
62.34.08	1/4" ID	Black	\$0.0445	\$0.0410	\$0.0375

Lockdown Shelf Supports

SKU	Shank Size	Shelf Thickness	Price per 1,000		
			100	1,000	5,000
62.631-25.00	1/4"	1/2"	\$0.086	\$0.066	\$0.055
62.641-25.00	1/4"	5/8"	\$0.100	\$0.0777	\$0.0636
62.841-5.00	5mm	5/8"	\$0.100	\$0.0777	\$0.0636
62.651-25.00	1/4"	3/4"	\$0.100	\$0.0777	\$0.0636
62.851-5.00	5mm	3/4"	\$0.100	\$0.0777	\$0.0636



Accessories

SKU	Description	Each
KT.KMA3232	Shelf Pin Jig	\$39.99
999.5MMB	5mm Drill Bit	\$14.99

speedbrace

SKU	Color	Size	Each
FC.SB21X28WH	White	21" x 28"	\$42.85
FC.SB21X24WH	White	21" x 24"	\$40.07
FC.SB15X18WH	White	15" x 18"	\$36.73
FC.SB8X12WH	White	8" x 12"	\$30.61
FC.SB5X8WH	White	5" x 8"	\$16.70
FC.SB21X28BL	Black	21" x 28"	\$42.85
FC.SB21X24BL	Black	21" x 24"	\$40.07
FC.SB15X18BL	Black	15" x 18"	\$36.73
FC.SB8X12BL	Black	8" x 12"	\$30.61
FC.SB5X8BL	Black	5" x 8"	\$16.70
FC.SB21X28SS	Stainless Steel	21" x 28"	\$119.39
FC.SB21X24SS	Stainless Steel	21" x 24"	\$111.04
FC.SB15X18SS	Stainless Steel	15" x 18"	\$79.60
FC.SB8X12SS	Stainless Steel	8" x 12"	\$45.93
FC.SB21X28PRM	Primed	21" x 28"	\$42.84
FC.SB21X24PRM	Primed	21" x 24"	\$40.07
FC.SB15X18PRM	Primed	15" x 18"	\$36.73



Speed Brace Features:

The heart of the Speed Brace is the 1 1/2" x 1 1/2" notching system that makes for fast and easy alignment after installing a level cleat along the wall. These braces offer a load capacity of 1,000 lbs per pair (on 16" centers.) Offered in 5 different sizes and 4 versatile colors, these Braces are also featured with holes for neatly routing wires or cables.



FC.SB-12HDSTEALTHBL



Stealth Countertop Supports

SKU (Standard)	Color	Thickness	Size	Each
FC.SB-12STEALTHBL	Black	3/16"	3.5" x 12"	\$15.73
FC.SB-12STEALTHPRM	Primed	3/16"	3.5" x 12"	\$15.73
FC.SB-12STEALTHWH	White	3/16"	3.5" x 12"	\$15.73
FC.SB-16STEALTHBL	Black	3/16"	3.5" x 16"	\$18.88
FC.SB-16STEALTHPRM	Primed	3/16"	3.5" x 16"	\$18.88
FC.SB-24STEALTHBL	Black	3/16"	3.5" x 24"	\$25.17
FC.SB-24STEALTHPRM	Primed	3/16"	3.5" x 24"	\$25.17
FC.SB-30STEALTHBL	Black	3/16"	.75" x 30" x .75"	\$28.31
FC.SB-30STEALTHPRM	Primed	3/16"	.75" x 30" x .75"	\$28.31

SKU (Heavy Duty)	Color	Thickness	Size	Each
FC.SB-12HDSTEALTHBL	Black	1/4"	3.5" x 12"	\$18.88
FC.SB-12HDSTEALTHPRM	Primed	1/4"	3.5" x 12"	\$18.88
FC.SB-16HDSTEALTHBL	Black	1/4"	3.5" x 16"	\$37.75
FC.SB-24HDSTEALTHBL	Black	1/4"	3.5" x 24"	\$50.34
FC.SB-30HDSTEALTHBL	Black	1/4"	3.5" x 30"	\$70.80

Heavy Duty Shelf & Workstation Brackets



Gray & Almond Available in Full Case Quantities. Please note there is a two-week lead time for these.

- Sold as a pair (left & right)
- Have a 3" x 3" (45° notch) to allow for a wall cleat and wiring
- 1/8" steel construction
- 1,000 lb load capacity per pair
- Multiple 1/4" mounting holes per side
- Textured powder coat finish
- Brackets are reversible

SKU	Color	Size	Case Qty	Price per Pair	
				Pair	Case
UF.7253180137	Black	8" x 12"	5	\$14.00	\$11.69
UF.7253182140	White	8" x 12"	5	\$14.00	\$11.69
UF.7253180142	Black	12" x 18"	3	\$26.80	\$22.38
UF.7253182145	White	12" x 18"	3	\$26.80	\$22.38
UF.7253180147	Black	15" x 21"	3	\$32.20	\$26.89
UF.7253182150	White	15" x 21"	3	\$32.20	\$26.89
UF.7253180152	Black	18" x 24"	3	\$43.60	\$26.41
UF.7253182155	White	18" x 24"	3	\$43.60	\$36.41

Ent. Center Door Hardware

Get all the flipper door hardware you need right here at Custom Service Hardware. Our selection of flipper door hardware includes hinge kits, door slides, overlay kits, shafts and more.

- 30 lb. Weight Capacity
- Poly-Bagged Complete with 36mm Inset Hinges (Everything for One Door)
- For Inset Application, Mount Front of the Slides Back 1/4"+ Thickness of the Door (From the Front of the Cabinet)
- Follower Strip is Installed After the Slides are Mounted
- Three Steel Ball Bearings per Inch of Race for Smooth, Quiet Movement
- Maximum Door Dimensions: 42"H x 24"W
- Multiple Hinge Options are Available
- All Slides are Black in Color
- Installation Instructions Available Upon Request

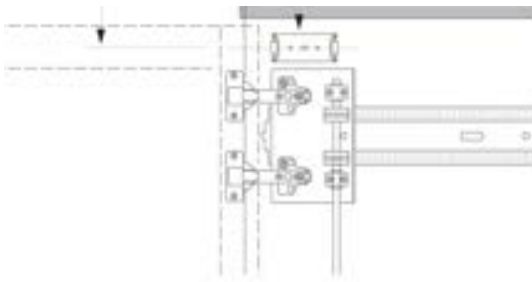

SKU	Length	Travel	Door Conceal	Cab Depth	Price per Each	
					Each	10-ct
KV.8070PEZEB12	12"	7 1/2"	8"	12 3/8"	\$58.38	\$48.75
KV.8070PEZEB14	14"	9 1/2"	10"	14 3/8"	\$59.34	\$49.55
KV.8070PEZEB16	16"	11 1/2"	12"	16 3/8"	\$60.24	\$50.30
KV.8070PEZEB18	18"	13 1/2"	14"	18 3/8"	\$61.08	\$51.00
KV.8070PEZEB20	20"	15 1/2"	16"	20 3/8"	\$62.08	\$51.84
KV.8070PEZEB22	22"	17 1/2"	18"	22 3/8"	\$62.98	\$52.59
KV.8070PEZEB24	24"	19 1/2"	20"	24 3/8"	\$63.98	\$53.42

(Optional) Hinge Kits & Accessories

Hinge Kits include everything to do one door.

SKU	Description	Price per Each	
		Each	10-ct
KV.8080F.B	35mm Cup w/Free Swing Knuckle	\$13.42	\$12.31
KV.8080S.B	Inset, 35mm Cup for 3/4" Door	\$16.48	\$13.76
KV.8080L.B	40mm Cup for 1/4" Overlay Application	\$19.95	\$16.66
KV.8085T.B	40mm Cup for Doors up to 1" Thick	\$18.68	\$15.60
KV.8086X.B	40mm Cup for Doors up to 1 1/4" Thick	\$18.68	\$15.60
KV.8090PCR	Roller Cassette: Provides Added Support to Raised Panel Doors	\$5.78	\$4.83
FT.CB40057R	40mm Boring Bit	\$67.59	n/a

Anti-Tip Kits, 50 lb. Capacity



Tip restraint exceeds the ASTM f2057-09 standard test requirements and are compliant with CPSIA, Section 101 Standard as well.

SKU	Description	Each
15.HH510	Anti-Tip Kit	\$1.40
15.HH510-P3	Warning Label	\$0.44

Plastic Corner Block with Tabs

2 1/2" x 2 1/2" x 3/4"



- Mounts with staples
- Strengthens cabinet corners

SKU	Price per Each			
	Each	100	250	1,000
62.1686.01	\$0.10	\$0.0968	\$0.0888	\$0.0825

Cabinet Corner Brace, White

1 1/4" x 1 1/4" x 3/4"



SKU	Price per Each		
	Each	100	1,000
30.1655.01	\$0.20	\$0.1680	\$0.1403

Easy snap cover provides access to covered screws and keeps unsightly screws out of sight.

Optional:

Recommended L Steel bracket for inside of corner bracket ([15.3412](#))

MAG SHIM 8 PC, POWERFUL MAGNETS

- [FC.MAGSHIMSTANDARD](#) \$30.25
- [FC.MAGSHIMMETRIC](#) \$24.20



Mag Shims

Magnetic Spacers for the Shop

Set blade height safely
Non-marking plastic
High performance magnets keep shims together on your saw
Add or remove shims for exact spacing

Mag Shims are the easiest way to set blade height and fence spacing on your table saw. Simply stick the magnetic shims together to get a perfect setup in seconds! Also great for setting depth on drill presses. Available in standard or metric sizes.

Features...

- Set spacing quickly & easily
- Standard: 1/4" to 1-1/8"
- Metric: 6mm to 30mm

Great for...

- Table saws & drill presses
- Setting router depth
- Spacing for layout projects

Description	Part Number	Price
Mag Shims Standard (8-18", 2-2 1/4")	MAG SHIM STANDARD	\$30.25
Mag Shims Metric (6-25mm, 2-30mm)	MAG SHIM METRIC	\$24.20

Floating Shelves

Floating Shelf Hardware with Screw-On Plate & Adjustment

Includes:

- (1) Shelf support
- (4) Plastic wall plugs
- (4) Screws

SKU	Min. Shelf Thick.	Each
HA.283.33.941	24mm (0.95")	\$4.78

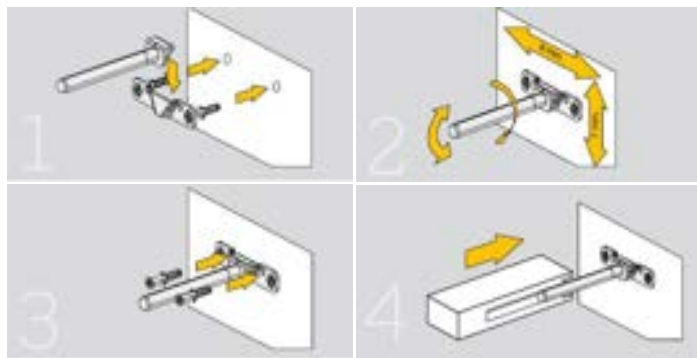

Weight Capacity
(with two supports on 900mm shelf, adding one support for every 450mm increase in length):



Hardware Bag

Includes:
(4) M5 x 12mm
Screws, & (4) M5
Weld Nuts

HA.020.92.761	Hardware Bag	\$4.11
---------------	--------------	--------

Shelf Depth	Max Weight Cap
175mm	44 lbs.
200mm	37 lbs.
225mm	33 lbs.
250mm	31 lbs.
275mm	29 lbs.
300mm	26 lbs.



Floating Shelf Extrusion Rail

HA.833.74.894	8-Ft. Length	\$39.86
---------------	--------------	---------

Choose One Decorative Coloured Profile Cover (REQUIRED if **Overlay**):

Coloured Sets for Concealing the Runner Profiles with a Coloured Cover, 2500mm



H.9209279	18mm Decorative Profile Cover, Black	\$15.01
H.9209284	18mm Decorative Profile Cover, Champagne	\$15.01
H.9209277	18mm Decorative Profile Cover, Silver	\$15.01
H.9209281	18mm Decorative Profile Cover, White	\$15.01

Contains all the components required for concealing 1 runner profile with a coloured cover

Floating Shelves

The unique Floating Shelves hanging system safely supports 15 pounds per running foot of shelf length, exceeding KCMA requirements. It **includes the installation hardware** and comes in a variety of sizes and wood species*.

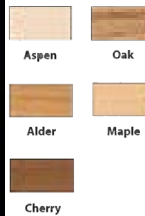

SKU	Dimensions	Weight Cap.	Each
Unfinished Maple			
67.FS0124MUF1	24" Length x 10" Depth x 2 1/2" Thick	30 Lbs.	\$119.91
67.FS0130MUF1	30" Length x 10" Depth x 2 1/2" Thick	37 1/2 Lbs.	\$125.80
67.FS0136MUF1	36" Length x 10" Depth x 2 1/2" Thick	45 Lbs.	\$146.76
67.FS0142MUF1	42" Length x 10" Depth x 2 1/2" Thick	52 1/2 Lbs.	\$161.17
67.FS0148MUF1	48" Length x 10" Depth x 2 1/2" Thick	60 Lbs.	\$172.61
Solid Wood & MDF Paint Grade Construction			
67.FS0124XUF1	24" Length x 10" Depth x 2 1/2" Thick	30 Lbs.	\$83.87
67.FS0136XUF1	36" Length x 10" Depth x 2 1/2" Thick	45 Lbs.	\$105.00
67.FS0130XUF1	30" Length x 10" Depth x 2 1/2" Thick	30 Lbs.	\$93.50

*See our website for other available wood species and sizes.



Closet Hardware

Sliding Door Hardware



Each Kit Contains:

- One track
- Installation instructions
- Four carriers (H.11333900)
- Four aprons (H.050565)
- One floor guide
- One wrench & necessary hardware

H.113336400	4' Set	\$185.13
H.113336500	5' Set	\$241.69
H.113336600	6' Set	\$253.84
H.113336700	8' Set	\$277.32

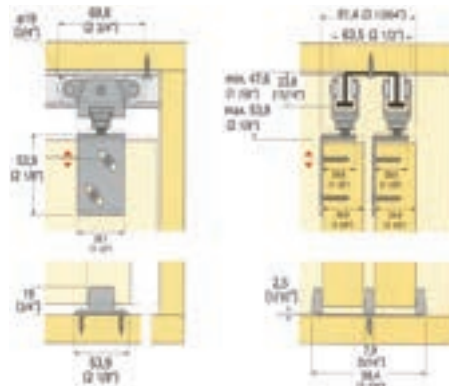

TopLine 72-138 Double Door Bi-Passing Set

- For Bi-passing application
- Carrier bolt "sits" in spherical carrier seat
- All parts are rust resistant
- Precision Ball Bearing Wheels
- 150 Lb. capacity
- Designed so the doors cannot jump the track
- Lock nut guarantees permanent positioning
- Conforms to ANSI/BHMA standards, Grade 1

Grant 75E Single Door Set Economy Door Set

- Single & Bi-parting Installations
- Conforms to ANSI/BHMA Standards, Grade 1
- Precision Ball Bearing Wheels w/ 75 lb. capacity
- Quick release mechanism for easy door installation
- 7/8" vertical adjustments
- Flexible System: Track can be used in Bi-fold 50 series



Each Kit Contains:

- One track
- Two carriers
- Installation instructions
- One floor guide
- Necessary screws
- Two quick release top plates

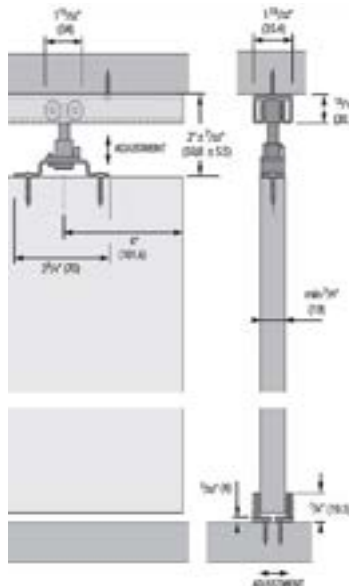

SKU	Kit Size	Price
H.1135337	4' Set	\$76.32
H.1135338	5' Set	\$79.49
H.1135339	6' Set	\$82.67
H.1135340	8' Set	\$95.39

Grant 150E Single Door Set Economy Door Set

- Single & Bi-parting installations
- Conforms to ANSI/BHMA Standards, Grade 1
- Precision Ball Bearing Wheels with 150 lb. capacity
- Pre-drilled aluminum box track
- 1/2" vertical adjustments, minimal headroom required
- Flexible System: Track can be used in Bi-fold 150 series



Each Kit Contains:

- One track
- Two carriers
- Installation instructions
- One floor guide 7051
- Necessary screws
- Two quick release top plates

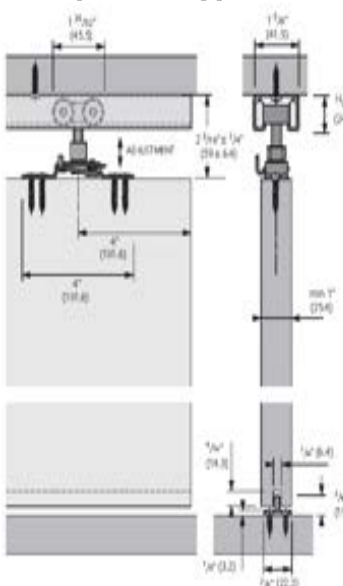

SKU	Description	Price
H.1135349	4' Set	\$95.39
H.1135351	6' Set	\$104.93

TopLine Grant SD

- Single & Bi-parting installations
- Precision Ball Bearing Wheels with 150 lb. capacity
- Self-leveling design
- Heavy duty track
- Conforms to ANSI/BHMA standards
- Anodized finish
- **Now compatible with the Add-On Soft-Close Mechanism (sold separately)**

Spec Sheet Available Upon Request



Each Kit Contains:

- One track (Anodized Finish)
- Installation instructions
- Two carriers with adjustable pendant bolts
- Two top plates
- One floor guide
- Two endstop catches
- Necessary screws

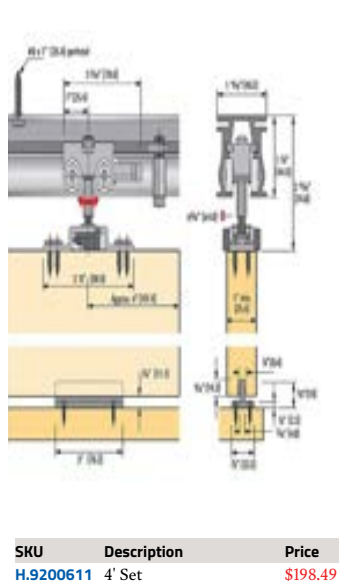

SKU	Description	Price
H.9200611	4' Set	\$198.49
H.9200613	5' Set	\$224.31
H.9200614	6' Set	\$238.60
H.9200616	8' Set	\$272.96
H.9200617	10' Set	\$293.88
H.9235608	Soft-Close Add-On	\$296.92

TopLine 71-222 Single Door Set

- Single & Bi-parting installations
- All parts are rust resistant
- Precision Ball Bearing Wheels with 150 lb. capacity
- Designed so the doors cannot jump the track
- Lock nut guarantees permanent positioning
- Vertical positioning up to 3/4"
- Conforms to ANSI/BHMA standards, Grade 1



Each Kit Contains:

- One track
- Installation instructions
- Two carriers (H.11333900)
- Two top plates with adjustable pendant bolts
- One floor guide
- One wrench and necessary hardware

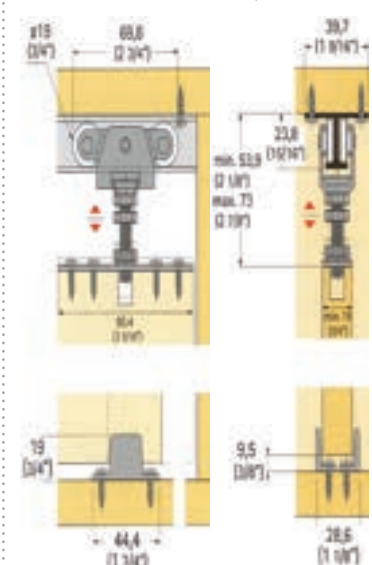

SKU	Description	Price
H.113334600	4' Set	\$115.95
H.113334700	5' Set	\$140.05
H.113334800	6' Set	\$145.89
H.113334900	8' Set	\$155.49

2200F Series Bypass Door Hardware Set

Two-Door with Fascia



- Track length: 60" [1524mm]
- Max door width: 30" [762mm] x2
- Door thickness: 1-3/8" [35mm]
- Hanger type: single wheel
- Max door weight: 50 lbs. [23kg]
- For two-door application
- Doors not included

Each Kit Contains:

- One track (60" length)
- Four door hangers
- One door guide
- Two satin nickel flush pulls
- Hardware mounting screws

SKU	Track	Price
JO.2200F601	60" Length	\$36.89

2200 Series Bypass Door Hardware Set, Two-Door



- Max door width: 36" [914mm] x2
- Door thickness: 3/4" [19mm] or 1-3/8" [35mm]
- Hanger type: single wheel
- Max door weight: 50 lbs. [23kg]
- For two-door application

Each Kit Contains:

- One track
- Two 2216 door hangers
- Two 2238 door hangers
- One 2135 door guide
- Two satin nickel flush pulls
- Hardware mounting screws

SKU	Track	Price
JO.2200482D	47"	\$25.36
JO.2200602D	59"	\$29.03
JO.2200722D	71"	\$32.87

1500 Series Pocket Door Hardware Set



- Max door size: 36" [914mm] Width x 80" [2032mm] Height
- Door thickness: 1" [25mm] - 1-3/4" [44mm]*
- Max door weight: 125 lbs. per door
- Minimum wall structure thickness of 3-1/2" [89mm] (2x4)
- Commercial grade door frame kit
- *Doors > 1-3/8" [35mm] possible; but require 1-3/4" [44mm] adaptor kit

Each Kit Contains:

- One 100 track length
- One passage end jamb bracket
- One pocket end jamb bracket
- Four steel wrapped split stud lengths
- Two door hangers
- Two 1-3/8" door floor brackets
- One pocket door guide
- One door bumper
- One adjustment wrench
- Hardware mounting screws

SKU	Price
JO.153068PF	\$164.30

1060 Series Single-Direction Soft-Close Hardware Kit



Each Kit Contains:

- One actuator arm
- One soft-close assembly
- One 1712 adjustment wrench
- One 1121 hanger plate
- Mounting Screws

- One single-direction soft-operation per kit
- For soft-close and soft-open application, purchase two kits (minimum 28" door width for bi-directional operation)
- For soft-operation in one direction, use a 1060 kit and a 1125 door hanger
- Maximum door weight of 200 lbs. per kit
- Minimum 24" pocket door width
- Compatible with the 1500 Pocket door frame

SKU	Price
JO.1060	\$62.35

1700 Series 4-Panel Bifold Door Hardware Set



- Track length: 60" [1524mm]
- Max panel width: 15" [381mm] x4
- Max panel thickness: 1-3/8" [35mm]
- Track type: brown rolled steel
- Max panel weight: 40 lbs. [18kg] (each panel)
- Max panel height: 96" [2438mm]

Each Kit Contains:

- One track (60" length)
- Two top pivot
- Six panel hinges
- Two panel guides
- Two bottom pivots
- Two top pivot locks
- Two bottom pivot brackets
- One adjustment wrench
- Two track stops
- One converging panel aligner
- Two door knobs
- Hardware mounting screws

SKU	Track	Price
JO.1700606H	60" Length	\$48.68

Dual Soft-Close Surface Mount Sliding Door Hardware, 200 Lb. Capacity



- 200 Lb. maximum door weight capacity
- Ceiling or wall mount options*
- Surface mounted door brackets
- Double rollers with ball bearings
- Quiet precision movement
- Soft-close feature
- Minimum door thickness: 1-1/8" [28mm]
- Minimum door width: 33-7/16" [850mm]
- Vertical adjustment of 1/16" [1mm]
- *A wall mount bracket must be purchased in addition to the Standard Aluminum Track in order to wall mount.
- *The False Ceiling Aluminum Track cannot be wall mounted with a wall mount bracket.

Choose One Track Type (REQUIRED):

- Standard Alum. Track: 78-3/4" L x 1-11/16" H x 1-3/8" D
- False Ceiling Alum. Track: 78-3/4" L x 1-11/16" H x 2-7/16" D (Cannot be wall mounted)

Standard Track

False Ceiling Track

SKU	Description	Each
Track Options		
SA.SDR-RABO-2000	78-3/4" Standard Aluminum Track	\$104.00
SA.SDR-RABO-TC-2000	78-3/4" False Ceiling Aluminum Track	\$104.00

Choose Additional Parts (OPTIONAL):

- You need one wall mount bracket in addition to the Standard Aluminum Track for wall-mount application
- Wall Mount End Cover is for use with the Standard Aluminum Track with a Wall Mount Bracket (sold individually)
- Ceiling Mount End Cover is for ceiling-mount applications

Wall-Mount Bracket

Wall-Mount End Covers

Ceiling-Mount End Covers

SKU	Description	Each
Wall-Mount Optional Parts		
SA.SDR-RABO-8085	End Covers for Wall-Mount Application	\$96.00
Ceiling-Mount Optional Parts		
SA.SDR-RABO-8083	End Covers for Ceiling-Mount Hardware	\$95.84

Choose Hardware Parts (REQUIRED):

- One hardware kit requires one Surface Mount Bracket Set, and two Soft-Close Rollers (sold individually) for recessed or surface mount sliding door hardware.

Surface Mount Bracket Set

Soft-Close Roller

SKU	Description	Each
Hardware Parts		
SA.SDR-RABO-SM-KIT	Surface Mount Bracket Set	\$20.16
SA.SDR-RABO-8006	Soft-Close Roller (Sold Individually)	\$232.00

Architectural Hardware

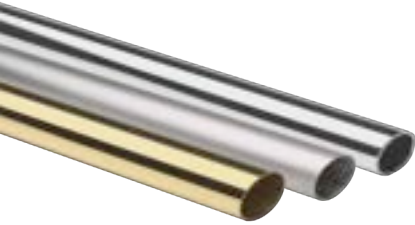

Foot Rail System

The small accents and fixtures go a long way in making a home's interior stand out. Adding unique elements is a great way to show off your style and maximize your home's potential. Get the perfect parts to add an elegant and classy look to your home!

Rail Tube Diameter	4 Foot Rail		6 Foot Rail		8 Foot Rail	
	SKU	Price	SKU	Price	SKU	Price
1.5" Brass	LI.00-A110/4	\$95.59	LI.00-A110/6	\$119.99	LI.00-A110/8	\$134.40
2" Brass	LI.00-A120/4	\$84.80	LI.00-A120/6	\$139.50	LI.00-A120/8	\$199.00
1.5" Stainless	LI.40-A110/4	\$40.80	LI.40-A110/6	\$85.99	LI.40-A110/8	\$73.60
2" Stainless	LI.40-A120/4	\$42.20	LI.40-A120/6	\$87.05	LI.40-A120/8	\$90.40
1.5" Satin Stainless	LI.44-A110/4	\$56.64	LI.44-A110/6	\$81.59	LI.44-A110/8	\$115.36
2" Satin Stainless	LI.44-A120/4	\$48.00	LI.44-A120/6	\$72.00	LI.44-A120/8	\$112.37



SKU	Flush Elbow	Price
LI.00-732/1H	1.5" Polished Brass	\$32.50
LI.00-732/2	2" Polished Brass	\$38.80
LI.40-732/1H	1.5" Polished SS	\$31.40
LI.40-732/2	2" Polished SS	\$47.30
LI.44-732/1H	1.5" Satin Stainless	\$36.80
LI.44-732/2	2" Satin Stainless	\$47.30



SKU	Flush Elbow, Radius	Price
LI.00-731/1H	1.5" Polished Brass	\$33.80
LI.00-731/2	2" Polished Brass	\$41.30



SKU	Half Ball end Cap	Price
LI.00-602/1H	1.5" Polished Brass	\$8.40
LI.00-602/2	2" Polished Brass	\$12.00
LI.40-602/1H	1.5" Polished SS	\$14.76
LI.40-602/2	2" Polished SS	\$15.40
LI.44-602/1H	1.5" Satin Stainless	\$13.97
LI.44-602/2	2" Satin Stainless	\$15.40



SKU	Ball Finial	Price
LI.00-604/1H	1.5" Polished Brass	\$30.00
LI.00-604/2	2" Polished Brass	\$48.20
LI.40-604/1H	1.5" Polished SS	\$31.10
LI.40-604B/2	2" Polished Stain	\$47.00
LI.44-604/1H	1.5" Satin Stainless	\$31.10
LI.44-604B/2	2" Satin Stainless	\$46.40



SKU	Combination Bracket	Price
LI.00-400/1H	1.5" Polished Brass	\$26.30
LI.00-400/2	2" Polished Brass	\$35.80
LI.40-400/1H	1.5" Polished SS	\$53.99
LI.40-400/2	2" Polished SS	\$44.30
LI.44-400/1H	1.5" Satin Stainless	\$55.12
LI.44-400/2	2" Satin Stainless	\$64.50



SKU	Bar Mount Bracket	Price
LI.00-402/1H	1.5" Polished Brass	\$32.50
LI.00-402/2	2" Polished Brass	\$39.30
LI.40-402/1H	1.5" Polished SS	\$41.00
LI.40-402/2	2" Polished SS	\$47.20
LI.44-402/1H	1.5" Satin Stainless	\$48.89
LI.44-402/2	2" Satin Stainless	\$47.20



SKU	Contemporary Bracket	Price
LI.00-406/2	2" Polished Brass	\$52.50



SKU	Flush Angle, 1350°	Price
LI.00-730/1H	1.5" Polished Brass	\$34.70
LI.00-730/2	2" Polished Brass	\$40.90

Minimum order of \$200 required or an additional \$25 fee will be applied to your order.



Tools

Dust Masks & Respirators

Moldex Respirators



Completely assembled Moldex Respirators for a variety of applications.

- **91.8112N** For Paint Spray/Pesticide (water-based products only).
- **91.8113N Includes:** 8000 Series facepiece, 91.8100 Replacement Organic Vapor Cartridge, 91.8910 N95 pre-filter and 8020 pre-filter retainer (for water-based products only).
- **91.8942 Includes:** 8000 Series facepiece, 91.8940 P100 Particulate Filter Disk, and 91.8900 Filter Disk holder including retainer ring.

SKU	Description	Size	Price
91.8942*	P100 Particulate	Medium	\$36.33
91.8112N	Paint/Pesticide	Medium	\$48.99
91.8113N	Paint/Pesticide	Large	\$55.32

*Lead abatement compliant. Not for use with Lacquer.

Moldex Cartridges and Prefilters for Moldex Respirators



New inhalation valve with each cartridge change, easy snap-on mount, and NIOSH Approved.

Prefilters come in packs of 10 (5 pairs)

- 91.8100 Organic Vapor \$17.99
- 91.8600 Gas/Vapor \$21.99
- 91.8910 Prefilters (10-pack) \$25.26
- 91.8940* Dust/Mist Prefilters (10-Pack) \$16.89

*Lead abatement compliant

Half Mask Respirator



Other accessories not included. It uses two low-profile P100 pre-filter cartridges (HG.7583P100) that are sold separately.

HG.7700 \$39.99

Low Profile P100 Pre-Filter



For organic vapors and acid gases and 99.97% filter efficiency for all particulates.

HG.7583P100 \$33.90

3M Dust/Mist Respirator



SKU	Box Qty.	Price Per Each	
		Each	Box
3M.8210	20	\$1.66	\$1.45

Dust/Mist Mask



91.2300 (pictured left): Standard dust/mist mask.
91.2700 (pictured right): Features Handstrap which allows mask to hang comfortably around neck when not in use.

SKU	Box Qty.	Price Per Each	
		Each	Box
91.2300	10	\$3.22	\$2.96
91.2700	10	\$4.99	\$4.33

Moisturizing Creams

O'Keeffe's Healthy Feet



Containing a high concentration of glycerin, Healthy Feet draws in and retains moisture, which is necessary for healthy, hydrated skin.

GG.OKHEALTHYFEET 3.2 oz \$6.99

O'Keeffe's Working Hands



For best results, apply after hand washing, bathing and at bedtime, as these are the most effective times for moisturizing extremely dry skin.

- GG.OKWORKINGHANDS 3.4 oz \$7.36
- GG.OKWORKINGHANDS6.8 6.8 oz \$11.99
- GG.OKWORKINGHANDSTUBE 3 oz Tube \$6.99

Ear Plugs

SparkPlugs PlugStation



Each dispenser is sealed, disposable and completely recyclable. A chute at the bottom of the dispenser makes these earplugs easily accessible. 500 pair earplugs included.

91.6645 \$115.00

Rockets Earplugs



Each pair includes convenient Pocket-Pak carrying case. Available without cord (91.6400) or with cord (91.6405).

SKU	Box Qty.	Price Per Each	
		Each	Box
91.6400	50 Pairs	\$1.46	\$1.32
91.6405	50 Pairs	\$2.45	\$1.28

SparkPlugs



Available without cord (91.6604) or with cord (91.6654).

SKU	Box Qty.	Price Per Each	
		Each	Box
91.6604	200 Pairs	\$0.22	\$0.19
91.6654	100 Pairs	\$0.37	\$0.34



Apron Woodturner, Black with fewer pockets and longer length, Ballistic nylon material. This Ballistic Apron has been designed specifically with the woodturner in mind. All of the aprons have been made out of an extremely rugged nylon that is in need
This product ships direct from vendor. Typical ship time is 2 business days.

FC.BWB 66.55

Misc. Work Accessories

Winbag Inflatable, Reusable Shim

Introducing the most precise tool to install windows, cabinets and more! With 300 lbs. of construction-grade lifting power per each Winbag, this hands-free and easy-to-use product will save you both time and money!

999.WINBAG \$17.27



9" Stainless Steel Pry Bar
Drop Forged and Heat Treated for Maximum Strength.

999.60039 \$6.20



Multi-Purpose Pliers 5 Piece Set

Includes 6" Diagonal Pliers, 6" Long Nose Pliers, 7" Slip Joint Pliers, 8" Linesman Pliers, and 10" Groove Joint Pliers

999.57055 \$22.73

FASTWRAP H AND L VELCROW 1/2 IN



FC.FW1210 \$13.57



Shop Dust Pan

Lies absolutely flat with hands-off use. Features super strong steel, light-weight, large size will accommodate a lawn rake or push broom.

999.161009 \$7.49



FastCap Pocket Chisel

- FC.PC1 1" Chisel \$30.25
- FC.PC34 3/4" Chisel \$30.25
- FC.PC12 1/2" Chisel \$30.25
- FC.PC14 1/4" Chisel \$30.25
- FC.PCDS Diamond Sharpener \$36.30
- FC.PPF Putty Knife \$14.52
- FC.PCP 5 in 1 Painters Tool \$14.65



FastCap Pocket Chisel Kit

Includes: 1" Chisel, 3/4" Chisel, 1/2" Chisel, 1/4" Chisel, Diamond Sharpener, Putty Knife, & Combo Putty Knife (5-in-1 Painter's Tool)

FC.PCKIT Pocket Chisel Kit \$157.30



FastCap Latex Skins HD Gloves

The Skins Heavy Duty are a high-performance textured latex gloves: snag, puncture and abrasion resistant. The latex provides superior grip in oily applications and yet these gloves are machine washable and dry extremely quickly. Great for general construction, lumber, millwork, or metal work.

- FC.SKINS-HD-S Small \$7.99
- FC.SKINS-HD-M Medium \$7.99
- FC.SKINS-HD-L Large \$7.99
- FC.SKINS-HD-XL Extra Large \$7.99



FastCap Magnifying Safety Glasses

Replace your prescription glasses with magnifying safety glasses while you're on the jobsite! They feature anti-fog coating and shatterproof, wrap-around lenses

- FC.SG-MAG1.5 1.5 Diopter Clear \$9.33
- FC.SG-MAG2.0 2.0 Diopter Clear \$9.33
- FC.SG-MAG2.5 2.5 Diopter Clear \$9.33
- FC.SG-MAG3.0 3.0 Diopter Clear \$9.33
- FC.SG-TAF-MAG1.5 1.5 Diopter Tinted \$9.33
- FC.SG-TAF-MAG2.0 2.0 Diopter Tinted \$9.33
- FC.SG-TAF-MAG2.5 2.5 Diopter Tinted \$9.33
- FC.SG-TAF-MAG3.0 3.0 Diopter Tinted \$9.33



FastCap Safety Glasses

These safety glasses have anti-fog coating, a rubber nose-bridge and shatterproof wrap-around lenses. They are great looking and designed for ultra comfort!

- FC.SG-P510 Regular Clear \$7.99
- FC.SG-T510 Regular Tinted \$7.99
- FC.SG-Youth-Clear Youth Clear \$6.67
- FC.SG-Youth-Tinted Youth Tinted \$6.67
- FC.SG-A510 Regular Amber \$7.99
- FC.SG-M510 Regular Mirror \$7.99
- FC.SG-GOGGLES Regular Clear \$7.99
- FC.SG-B510 Regular Blue \$7.99
- FC.SG-R510 Regular Red \$7.99



Nitrile Skin Gloves

These seamless gloves have exceptional grip and are excellent for puncture/abrasion resistance.

- FC.SKINSM Small \$6.67
- FC.SKINMED Medium \$6.67
- FC.SKINLG Large \$6.67
- FC.SKINXL Extra Large \$6.67



Left to right: FC.PLIERSHDFC, FC.PLIERSFC, FC.PLIERSMFC

FastCap Flush Cut Trimmers

- FC.PLIERSHDFC Heavy Duty \$26.60
- FC.PLIERSFC* Macro \$19.98
- FC.PLIERSMFC* Micro \$13.29

*Not for nail-trimming use



FastCap End Nip Trimmers

The End Nip Trimmers have a flush 1" wide head that can be used for cutting fret wires on guitars, edgbanding up to 3mm, and a variety of other applications. Great for trimming metals like brass and copper.

FC.PLIERSEN \$19.93



FastCap Power Shears

FastCap's Power Shears cut through the toughest materials and are compact for your convenience!

FC.POWERSHEARS \$19.93

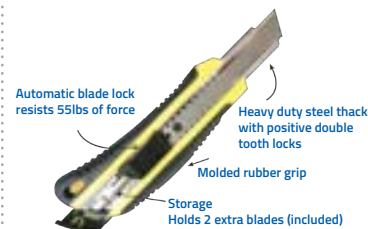

FastCap TriBlade Utility Knife

Triblade Knife includes three 0.5mm snap-off blades.

- FC.TRIBLADE TriBlade Knife \$4.00
- FC.TRI.BULK.REP Blades (10 Pack) \$2.66

Heavy duty steel thick with positive tooth locks



FastCap Kaizen Knife

- FC.KAIZENKNIFE Kaizen Knife \$3.34
- FC.KAIZENBLADE Blades (10 Pack) \$2.66



FastCap Long-Nosed Pattern Marker

The marker that will solve all your tricky layout problems! It is the ultimate permanent waterproof marker with a super fine, long tip on one end and a wide tip on the reverse end.

FC.LNM	Black	\$6.67
FC.LNM-GOLD	Gold	\$6.67
FC.LNM-SILVER	Silver	\$6.67



FastCap Fat Boy Pencil

Sturdy, easy to sharpen, and stays sharp longer than any other pencil! Pencil lead retracts inside for safe storage. 3 lead, 1 white crayon, and 1 red crayon included.

FC.FATBOYPENCIL	Pencil	\$19.98
FC.FATBOYREFILL	Lead Refill	\$5.32
FC.FATBOYREDREFILL	5 Red Crayons	\$5.32



Connector Kit

3rd Hand HD Contractor Kit

The 3rd Hand HD Contractor Kit is everything you've been looking for. It is built to last a lifetime and it's never late for work! Comes with everything you need to implement the 3rd hand system into your job site! Material: Steel & ABS
Load Capacity: 150 Lbs.
Extension Range: 57" - 144"
Outer Pole Diameter: 1-3/16"

Includes:

- (4) 3rd hands
- (8) Articulating Feet
- (4) Magnetic Dust Feet
- (4) Universal Feet
- (1) 3rd Hand Bag

FC.3HCONTRACTPK \$353.44

FastCap 3rd Hand

If you ever wished you had an extra hand, look no further. It is rugged, built to last a lifetime and it's never late for work! Brace, jack, or support whatever you need.



Magnetic Dust Barrier Door System

Includes: (1) Top Rail, (1) Magnetic Dust Door, (2) Carrying Bags, (10) Magnetic Strips, and (2) 3rd Hand HD w/Dust Barrier Feet

FC.3HMAGDOORSYSTEM \$320.05

Dust Barrier Door

Includes: (1) Top Rail, (1) Magnetic Dust Door, (1) Carrying Bag, and (10) Magnetic Strips.

FC.3HMAGDOOR 3rd Hand Dust Door \$139.15

Magnetic Strip

FC.3HMAGSTRIP Magnetic Strip \$11.13



FastCap 3rd Hand HD

- Extends from 5 ft. to 12 ft.
- Load capacity: 150 lbs.
- Magnetic dust barrier foot
- Precision pump jack
- Ball detents for positive locking
- Micro adjustable
- 360 Degree articulating foot

FC.3H5HD	1 pack	\$69.58
FC.3H5HD2PK	2 pack	\$125.24



3rd Hand Heavy Duty Upper Hand & Little Hand

The **Upper Hand** is FastCap's mid-sized hand and extends from 28"-60".

The **Little Hand** is FastCap's smallest hand and extends from 16.5"-22.8".

Both have a **max load capacity of 150 lbs.**

FC.3HUPPER2PCSYS	2 Upper Hands with Bag	\$144.21
FC.3H15.7HD	Little Hand	\$55.66
FC.3HLITTLE2PCSYS	2 Little Hands with Bag	\$119.67



3rd Hand EMT Kit

- (1) 3-H Pump Jack Mechanism (150 lb. load capacity)
- (1) Micro Adjust Adapter
- (1) Universal Feet - 6"x6"
- (1) 3-H Feet - 3"x3"
- (1) 3-H Magnetic Dust Barrier Foot
- (1) 24" Connector Pole (to connect two EMT sections together)

FC.3HEMTKIT \$61.23



FastCap 3rd Hand Tripod

Features:

- Folds down to a convenient, compact size
- Adjustable height, up to 5"
- Non-marring feet
- Works with Upper Hands, 3rd Hands, and EMT

Great for:

- Magnetic Laser Mount for lasers
- Supporting lumber and piping for cutting
- Use with planers, shapers, miter saws and table saws
- Free standing Upper Hands & 3rd Hands and EMT

FC.3HTRIPOD	Tripod Only	\$33.40
FC.3HROLLTRISYSTEM	Tripod & Upper Hand System	\$130.80



FastCap 3rd Hand 12" Roller

This stainless steel support roller is ideal for both heavy wood and metal stock. Its 12"-wide roller uses precision ball bearings for smooth movement, and is compatible with the Little, Upper and 3rd Hand. Supports up to 150 lbs.

FC.3HROLLERTOP \$33.40

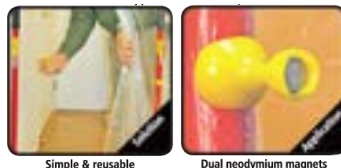

FastCap Door Mag

The Door Mag eliminates the need to buy expensive single-use, self-adhesive zippers. FastCap's door mags easily create in and out access through any dust barrier wall. Rare earth magnets hold barriers firmly in place on your 3rd Hand pole.

SKU	Qty.	Price
FC.3HDM	4	\$27.83



Magnetic Lasermount

Compact and easy to adjust
Rotates 360° in three places

FC.3HMLMT \$41.75

Shipping & Packaging Supplies



Folding Locking Utility Knife

Features: Quick-change blade mechanism, comfort-grip ABS handle, blade storage compartment with spring release, five spare blades included.

BT.D-BKPH

\$20.06



Hand Wrap

62.HW-390	3"	90 Gauge	\$5.40
62.HW-580	5"	80 Gauge	\$8.83



Shrink Wrap

62.HW-1870	18"	70 Gauge	\$27.50
------------	-----	----------	---------



Shrink Wrap Holders

62.HCD	\$12.42
--------	---------

To be used with
62.HW-1870
Shrink Wrap

FREE handle when you purchase six or more 3" or 5" hand wraps!



Shrink Wrap Handle

62.HW-H	\$0.99
---------	--------

Tape

Tape Dispenser



For a 220 yard length roll.

62.006	For 2" Wide Tape	\$16.76
62.EX-388	For 3" Wide Tape	\$24.90



Clear Tape, 110 Yards

		Price per Each	
SKU	Type	Each	Case Qty Case
CSH.23199	2" Roll	\$2.42	36 \$2.22
CSH.7100-3	3" Roll	\$4.92	24 \$4.48



Masking Tape, 2" x 60 yds.

		Price per Each		
SKU	Each	Case Qty	Case	
3M.200.48	\$6.01	24	\$5.52	



Filament Tape, 18mm x 55m

		Price per Each		
SKU	Each	Case Qty	Case	
3M.8934	\$4.96	48	\$4.65	



Gorilla Tape

Gorilla Tape is made to stick to rough, uneven, unforgiving surfaces like wood, stone, stucco, plaster, brick and more. Heavy duty cloth backing gives extra strength and heft.

GG.TAPE	1.88" x 35 Yd	\$10.33
---------	---------------	---------

Folding Locking Utility Knife, Wood Handle



Features: Folding and locking blades with belt-clip, quick blade exchange (uses standard blades) and spring blade release.

BT.D-BKWH	\$24.73
-----------	---------

Movers



Forearm Forklift

Features: Strong nylon webbing, 600 Pound weight capacity, perfect for getting heavy stuff out of the way, adjustable up to 48", criss-cross straps underneath to prevent slipping.
Includes one set of straps.

999.FF \$24.28



10 Million Dollar Stick

Make dangerous cuts safe for your fingers with the 10 Million Dollar Stick. The ergonomic design and rubberized traction foot gives you a safer and more precise cut.

FC.10MILLIONSTICK \$18.15



Levels



Big J Pro Heavy Duty I-Beam Aluminum Level

- Heavy Duty aluminum frame assures durability and accuracy
- Ergonomic cushioned hand grips
- Surroundview® vials reflect ambient light for easy-read
- Removable end caps designed for finish carpentry work

JL.1253-2400	24"	\$32.95
JL.1253-4800	48"	\$62.95
JL.1253-7200	72"	\$87.95

Speed Skate

Gorilla Tape is made to stick to rough, uneven, unforgiving surfaces like wood, stone, stucco, plaster, brick and more. Heavy duty cloth backing gives extra strength and heft.

FC.SPEEDSKATE \$36.30



Tough polyurethane wheels



Move 4' x 8' sheets solo



Perfect for moving doors

Speed Skate™

NEW

Load Capacity 500lb

Supports materials up to 1-3/4" wide

The Speed Skate allows you to move large & heavy materials around the job as they lay by yourself. It easily supports 4' x 8' sheets of material up to 1-3/4" wide. Large wheels and ball bearings allow you to move loads without struggle.

Features...

- Tough Polyurethane wheels
- Ball bearings for smooth operation
- Supports up to 1-3/4" width

Great For...

- Plywood
- Doors
- Countertops

Description	Part Number	Price
Speed Skate Sheet Dolly	SPEED SKATE	\$36.30

©2011 Johnson Hardware

FastCap Kaizen Foam



Designed to help you achieve maximum organization and visual control of your workspace! The foam peels away in layers creating a perfect fit for all your tools in drawers or on walls.

FC.KF20.2X4.BL	20mm	Black	\$15.83
FC.KF30.2X4.BL	30mm	Black	\$20.58
FC.KF57.2X4.BL	57mm	Black	\$32.67

FastBreak Sander by FastCap



FC.FASTBREAK	FastBreak	\$9.33
FC.FASTBREAKXL	FastBreakXL	\$19.98
FC.FB180.10PC*	180 Grit Sandpaper	\$5.32
FC.FB080.10PC*	80 Grit Sandpaper	\$5.32

Uniformly break the edge on sharp melamine material in just one pass! The fastbreak and fastbreak XL use the same sandpaper refills. The fastbreak uses 1 sheet at a time while the XL uses 2 sheets.

Kliss Clamp



Kliss Clamp holds your panels upright so you can apply Fastedge, SpeedTape or sand with ease! It's great for door prep, cabinet prep and cabinet assembly projects!

FC.KLISSCLAMP	\$48.40
-------------------------------	---------

FastCap Pro Carpenter AutoLock Tape Measures



The ProCarpenter AutoLock tape measure has all the features of the original ProCarpenter, plus the autolock and super-ergonomic design. Simply pull the blade out and it stays in place. Then, push the release button to retract the blade.

SKU	Description	Each
Standard Reverse		
FC.PSSR-16AUTO	Lefty/Righty (PSSR)	\$13.31
Metric Standard		
FC.PMS.16LOCK	Stand./Metr. (PMS)	\$13.31

FastCap Pro Carpenter Flat Back Tape Measure, 16'



Not all surfaces are flat! The ProCarpenter FlatBack is a flexible tape for measuring curves and flat panels with precision and ease.

FC.PMS.F16	Metric Standard	\$10.00
FC.PSSP.F16	Standard Story Pole	\$9.99
FC.PMMR.F16	Metric Reverse	\$9.99
FC.PS.F16	Old Standby	\$9.99

FastCap SpeedClip



Mount to a bench or clip it on your belt to save your pant's pocket from unnecessary wear!

FC.SC	\$2.00
-----------------------	--------

FastCap Blade Styles

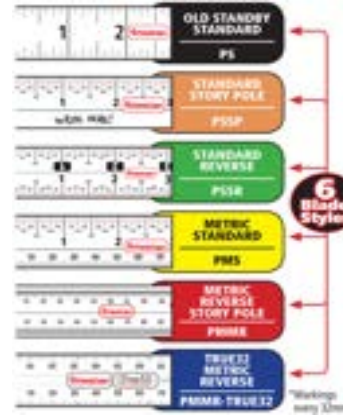

Metric/Standard		
FC.PMS.12	12'	\$9.33
FC.PMS.16	16'	\$10.00
FC.PMS.25	25'	\$14.65
Standard Reverse		
FC.PSSR-16	16'	\$9.99
FC.PSSR-25	25'	\$14.65
Standard Story Pole		
FC.PSSP-16	16'	\$9.99
FC.PSSR-25	25'	\$14.65
Metric Reverse		
FC.PMMR.5	5 M	\$9.99
Old Standby		
FC.PS.16	16'	\$9.99
FC.PS.25	25'	\$14.65
True 32 Metric Reverse		
FC.PMMRTRUE32	5 M	\$9.99

FastCap Pro Carpenter Tape Measure

The ProCarpenter Tape Measures are developed with 7 innovative features: lever action belt clip, pencil sharpener, dual locking system, erasable notepad, heavy-duty 1-inch blade, high-contrast tape and rugged compact design.

ChopShop Saw Hood



The Saw Hood was designed by a general contractor to eliminate the catastrophic dust problem created by miter saws. Sets up in seconds and contains 95% of dust. You will be amazed at how effective this product is. The Saw Hood Pro is identical in function to the Saw Hood but is made out of a spring steel so it can fit into a compact bag. If space is an issue, this is the tool for you.

FC.SAWHOOD	ChopShop Saw Hood	\$241.85
FC.SAWHOODTC	Mounting Bracket	\$30.61



Kreg® Products

Pocket Hole Tools

CSHardware offers some of the best drill jigs and pockethole machinery on the market. Famous for their high-quality and user-friendly products, Kreg provides tools that are sure to be the perfect fit for your project.



KT.KPHJ720PRO

\$149.00

Kreg Pocket Hole Jig 720PRO

The Pocket-Hole Jig 720PRO is our ultimate joining set up and it's the premium choice for project builders who want a full suite of 700-Series tools and accessories in one package.

The 720PRO brings you everything you need to get building and keep building.

With the Pocket-Hole Jig 720PRO, you get the Kreg Docking Station material support wings with a repeatable stop, a Pocket-Hole Jig Clamp, 160 Kreg pocket-hole screws, and a free project plan so you can start building right away.



Mini Kreg Jig Kit

Includes: Mini Kreg Jig, 3/8" Step Drill Bit (KT.KJD), Depth Collar and Allen Wrench (KT.KJSC).

KT.MKJK

\$14.99



Kreg Jig HD (Heavy Duty) Kit

Includes: Drill Guide, Stop Block 1/2" Dia. Stepped Drill Bit, Stop Collar and Allen Wrench, 6" Driver Bit, Starter Screw Set.

KT.KJHD

\$69.99

Pocket-Hole Machinery



Kreg Foreman Pocket-Hole Machine

This professional grade pocket-hole machine comes at a consumer friendly price and will have you building with twice the speed and half the effort of a standard pocket-hole jig.

KT.DB210 Pocket-Hole Machine \$399.00



Kreg Pro Series Multi-Spindle Electric Pocket-Hole Machine

Features: 3/4", 1", and 1 1/4" spindle spacings; hardened steel drill guide maximizes drill bit life; one-touch, foot pedal operation; swing Stops™ for optimized material positioning; dust collection chutes for efficient chip removal.

KT.DK3100

\$5,999.00



Shelf Pin Jig

Includes: Shelf Pin Jig w/32mm Hole Spacing, 1/4" Hole Size, 1/4" Drill Bit, Locating Pin, Jig Extender, Depth Collar.

KT.KMA3225

\$39.99



R3 Kreg Jig Kit

Includes: R3 Jig, Clamp Adapter, One 3/8" Step Drill Bit (KT.KJD), 6" Driver Bit, Depth Collar, Allen Wrench (KT.KJSC), And Assorted Screws.

KT.R3

\$34.00

Drawer Slide Mounting Tool

Features: Accurate slide positioning with built-in indexing tabs; repeatable results without measuring and marking; versatile for use in cabinets, cases, etc.; reversible to mount slides to cabinet and drawer box; secure for holding slides in place as you work; strong, and lightweight materials for easy handling.



KT.KHI-SLIDE

\$29.99

35mm Concealed Hinge Jig Bit

Works with all 35mm concealed hinges. The spurs create clean hole edges without tearout. The shoulder ensures accurate stop-collar positioning (stop collar sold separately with Concealed Hinge Jig).



KT.KHI-BIT

\$19.99

More Drill Bits



KT.KJDHD

Kreg Jig HD Drill Bit

Replacement drill bit. Only compatible with Kreg Jig HD (KT.KJHD).

\$29.00

Kreg Step Drill Bit 3/8"

KT.KPHA308

\$18.99

Kreg HD Drill Bit

KT.DB210-HDB

\$34.99

Kreg HD Drill Bit W/Bushing

KT.DB210-HDBB

\$54.99

Micro Drill Bit w/Bushing

KT.DB210-MBB

\$54.99



KT.KPHA540

Micro Depth Collar & Allen Wrench

Replacement drill bit. Only compatible with Kreg Micro-Pocket Drill Guide (KT.KJMICRODGB).

\$20.99

Kreg 3/8" Stepped Drill Bit 6 3/4" (L) For Pocket-Hole Machines

KT.DKDB

\$44.99

Pocket Hole Plug Accessories

Custom Pocket-Hole Plug Cutter
Includes: Custom Pocket-Hole Plug Cutter, Custom Plug Cutting Bit (for standard pocket-hole sizes), Bit Stop Collar, Hex Wrench & Owner's Manual. Fits into any Kreg Jig.
KT.KPCS \$79.00

Custom Plug Cutting Bits

SKU	Fits	Each
KT.KPC1020	Standard Pocket Holes	\$57.99
KT.KPC1040	Micro-Pocket Jig Holes	\$57.99
KT.KPC1060	Heavy-Duty Pocket Holes	\$57.99



Kreg Pocket Hole Plugs, White
 Use plastic pocket-hole plugs from Kreg to hide or decoratively accent exposed pocket holes in painted or laminated surfaces!
Note: 50 caps per pack
KT.CWHT White \$8.99



Solid Wood Screw Hole Plugs
 High-quality, trimmable, solid wood plugs for pocket holes. For use with materials from 1/2" - to 1 1/2" thick.
Note: 50 caps per pack
KT.PMAP Maple \$10.99
KT.POAK Oak \$10.99
KT.PPNT Paint Grade \$7.69
KT.PPIN Pine \$10.99

Clamps

Kreg Automaxx Bench Clamp w/ Automatic Adjustment
 It has easy-to-regulate clamping force using a simple thumbscrew, extra-large padded clamp to evenly spread pressure, an ergonomic padded grip, and heavy-duty all-metal construction. Compatible with Kreg Klamp Plate, Klamp Trak, and Klamp Vise Plate

Clamps materials up to 3 3/4" Thick
KT.KBC3 3" Clamp \$49.99

Clamps materials up to 5" Thick
KT.KBC6 6" Clamp \$52.99

Kreg Automaxx Heavy Duty Bench Klamp System

For 360° clamping on the go, check out the Heavy-Duty Bench Clamp System. It features a bench clamp with a thick 10" x 10" powder-coated steel plate and has rubber feet that allow it to be used anywhere. Alternatively, the plate can be recessed into a work surface.
KT.KBC3-HDSYS \$84.99

Kreg 3" Bench Clamp

using an extra-large padded clamp face that evenly distributes clamping force.
KT.KBC3-BAS \$69.99

Kreg Movable Bench Clamp Base

The Movable Bench Clamp Base allows you to get more from any work surface that's equipped with 3/4" or 20mm bench dog holes. Or, you can simply drill a hole in any work surface, and easily attach the Bench Clamp Base, and just as easily remove it when not in use, or move it to another location.
KT.KBCBA \$24.99

Bench Clamps work with Clamp Trak and Plates, the Clamp Table, Mobile Project Center, and more to secure workpieces

Right Angle Clamp

The Right Angle Clamp holds the parts of a 90° joint in position as you drive in the screws. Just slip the pin on the Right Angle Clamp into a pocket hole, close the clamp, and it draws the mating pieces tightly together!
KT.KHCRA \$44.99

90° Corner Clamp

Self-squaring design; automatically aligns joints to 90-degree angle. swivel head can easily adjust for materials up to 1" thick.
KT.KHCCC \$49.99



KT.KBK-IP \$19.99

Klamp Plate Insert
 Accepts any Kreg Bench Klamp™ for a versatile clamp setup!

Kreg Automaxx Bench Klamp System

This clamp system combines a 3 Automaxx Bench Klamp with a Kreg Klamp plate and clamps materials up to 2 1/2" thickness. Features heavy-duty, all metal construction, ergonomic padded grips, and easy-to-regulate clamping force using a simple thumb screw.
KT.KBC3-SYS \$69.99

Router & Saw Accessories

Miter Gauge
Features: 24" fence fits most table saws; positive stops at 0, 10, 22 1/2, 30 and 45 degrees; adjustable to 1/10 of a degree 5 bar stops to eliminate play in the fence
KT.KMS7102 \$159.00



Kreg Rip-Cut Circular Saw Guide
 You can get great results when cutting with a circular saw without measuring, marking, or struggling to keep the saw on your cut line. With the Kreg Rip-Cut™ saw guide, you'll make straight, accurate cuts every time in plywood, MDF, and other large sheet goods.
KT.KMA2685 \$44.00



12' Self-Adhesive Measuring Tape

KT.KMS7724 L-R Read \$11.99
KT.KMS7723 R-L Read \$11.99



Band Saw Fence
Features: Quickly mounts to most 14" tables; fence removes in seconds; can adjust for blade drift.
KT.KMS7200 \$139.00



Precision Trak & Stop System
Features: Flip stop for single cuts and production stop for repeated cuts on your miter or radial arm saw; eight total feet of track; easy installation.
KT.KMS8000 \$159.00

Klamp Table w/Steel Stand



KT.KCT-COMBO

\$449.99

Whether you're joining, sawing, sanding, or routing, having a table that was designed and built with clamping as its primary focus makes all the difference in the world.

Includes:

- Two 3" (76mm) bench clamps with auto-adjust technology.
- Durable melamine surface that resists glue and is easy to clean.
- Two lengths of clamp trak that allow easy clamp positioning.
- Five Clamp Blocks which make it easy to square up assemblies.
- Multi-purpose shop stand.



Router Table

Features fast and easy assembly, a universal steel stand, heavy gauge steel construction 29" to 35" height adjustability, stable leveling feet, and a durable painted finish.

Note: Does not include casters.

KT.PRS1045

\$599.99



Precision Beaded Face-Frame System

The fastest, easiest, and most affordable way to build beaded face-frames in a home shop. Features an adjustable integrated clamp, control arm, sliding base, and router table stop.

KT.PRS1200

\$449.99



Accu-Cut™ XL

Transform your circular saw into a high-performance, track-guided cutting tool for breaking down full sheets of plywood with cuts up to 100"

Set your projects up for success by making straight, accurate, splinter-free cuts with the Accu-Cut™ XL Circular Saw Track Guide. It rips, crosscuts, and makes angled cuts up to 100" long in plywood, MDF, and other large panels with accuracy and control.

KT.KMA.3700

\$179.99



The Accu-Cut™ XL guides your circular saw along an extended-length aluminum track that holds the saw steady and keeps your cuts straight. The track guide is designed for simplicity: just mount your saw to the Universal Sled, align the Accu-Cut™ XL track to the cut line, and make the high-quality cuts you need. The anti-chip guide strips prevent splintering and tearout through the entire length of your cut. The same strips also feature an anti-slip surface that holds the track in place without clamps.

Kreg In-Line Clamp

The In-Line Clamp gives you the helping hand you need, when you need it, with the versatility and power you want for a wide variety of do-it-yourself and woodworking tasks. The clamp applies up to 250 lbs. of clamping force and swivels to clamp from any angle on almost any shape workpiece or assembly.

KT.KBCIC

\$24.99



Cleaners, Lubricants, & Laminate Supplies

Cleaners & Lubricants



Bostik Cleaners & Lubricants

GlideCote Table & Tool Surface sealant dramatically reduces sliding friction on table saws while repelling dust, dirt, and moisture. Contains no silicone or petroleum.

BladeCote creates a clear, tough, thin coating on any blade or bit. It reduces friction, extends blade life, and allows your blades and bits to create cleaner, truer cuts.

Bearing Lubricant protects your tools and equipment from dirt and moisture. Not only does it withstand heat and pressure that would vaporize normal bearings, but it also penetrates bearings and extends their life!

SKU	Type	Vol	Case Qty	Price Per Each	
				Each	Case
66.BLADECOTE	BladeCote	10.75 oz	12	\$24.20	\$24.20
66.GLIDECOTE	GlideCote	10.75 oz	12	\$24.20	\$24.20
66.BL-5.5A	Bearing Lube	5.5 oz	12	\$12.95	\$11.95



SLIPIT Spray Lubricant With Silicone

Non-toxic SLIPIT Lubricant works for nearly endless applications. It is available with or without silicone in liquid, gel, or aerosol.

SKU	Size	Type	Price
With Silicone			
SI.11237	11 oz.	Aerosol Can	\$8.65
SI.16435	16 oz.	Gel Can	\$10.99
SI.32435	32 oz.	Gel Can	\$15.30
Without Silicone			
SI.16595	16 oz.	Spray Liquid	\$12.50
SI.16447	16 oz.	Gel Can	\$10.99
SI.32447	32 oz.	Gel Can	\$15.30

Ballistol Lubricant and Cleaner



Ballistol is the world's most useful and environmentally friendly lubricant since 1904. Use Ballistol to lubricate, clean, protect, and preserve your firearms, leather, wood, metal surfaces and much more!

SKU	Description	Price
66.120014	1.5 oz aerosol	\$4.79
66.120045	4 oz Non-Aerosol	\$8.49
66.120069	6 oz Aerosol	\$10.49
66.120076	16 oz Non-Aerosol	\$17.99
66.120106	Wipes, 10 per Box	\$4.79



Hope's Counter Top Polish

Cleans, shines & protects your kitchen surfaces! These products are wax free with no build up. Make your home surfaces shine with these polishes.

SKU	Description	Oz	Each
L.HO-8BTP	Counter Polish	8	\$4.99
L.HO-8SSP	Stainless Steel Polish	8	\$4.99
L.HO-10SSCP	Solid Surface Cleaner & Polish	10	\$4.99
L.HO-95K12	Perfect Sink	8.5	\$4.99



Lami-Lube Spray Lubricant

- **66.LAM:** Prevents burns and scratches from self-guiding cutters on laminate. No messy cleanup. Fast & easy.
- **66.LAM.3:** Lubricates saw tops, tools, and blades.

SKU	Case Qty	Price Per Each	
		Each	Case
66.LAM	12	\$6.62	\$6.14
66.LAM.3	12	\$9.55	\$8.87

CMT Oscillating Blades

Because of their intense investment in advanced production technology, CMT offers industrial tooling at an affordable price to an ever-growing following of professionals and hobbyists alike.

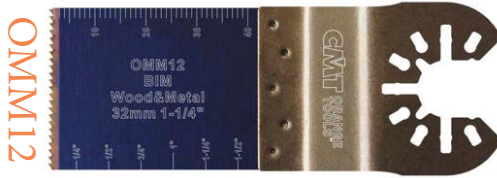

CMT 1 1/4" Plunge and Flush-Cut Blade

Cutting width: 1 5/8"

CMT.OMM12-X1	1 Ct.	\$6.33
CMT.OMM12-X5	5 Ct.	\$30.85

Blades for Wood and Metal

TPI: 18
Features: bimetal with 8% cobalt teeth.
Works best for: wood, plasterboard, plastic, sheet metal, copper and aluminum pipes and profiles.

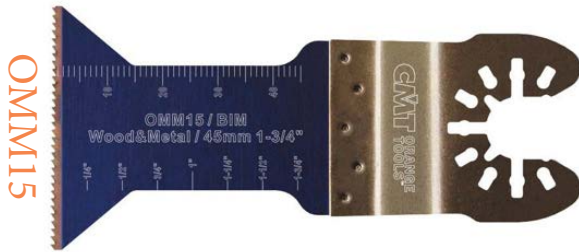

CMT 1 3/4" Plunge and Flush-Cut Blade

Cutting Width: 1 7/8"

CMT.OMM15-X1	1 Ct.	\$8.72
CMT.OMM15-X5	5 Ct.	\$42.24

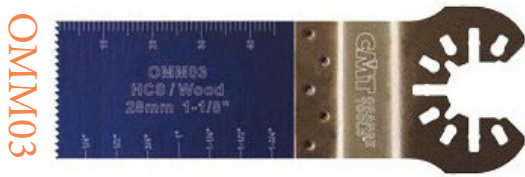

Long Life Blades for Wood

TPI: 18
Works best for: wood, blockboard, chipboard, plastic, pipes and profiles

1 1/8" Plunge and Flush-Cut for Wood

Cutting Width: 7/8"
Features: HCS with hardened teeth.
 CMT.OMM03-X1 1 Ct. \$4.18

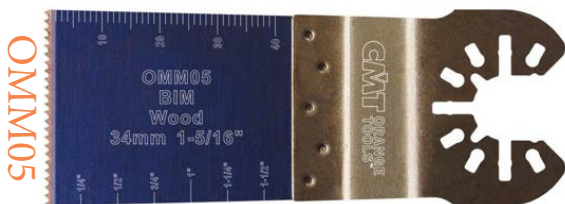

1 3/8" Extra Long Life Plunge and Flush-Cut for Wood

Cutting Width: 1 5/8"
Features: Bimetal with 8% Cobalt teeth guarantee extra-long life.
 CMT.OMM05-X1 1 Ct. \$5.97
 CMT.OMM05-X5 5 Ct. \$28.91



1 1/16" Extra Long Life Plunge and Flush-Cut for Wood

Cutting Width: 1 5/8"
Features: Bimetal with 8% Cobalt teeth guarantee extra-long life.

CMT.OMM07-X1	1 Ct.	\$7.79
CMT.OMM07-X5	5 Ct.	\$32.82

Japan Tooth Blades for Wood

TPI: 14
Features: HCS with Japanese double-row pattern, hardened teeth.
Works best for: wood, timber, blockboard, chipboard

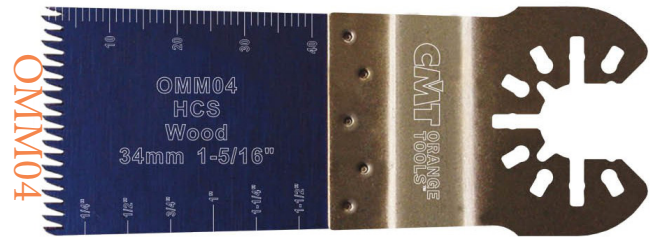

1 3/8" Precision Cut, Japan Tothing for Wood

Cutting Width: 1 37/64"
 CMT.OMM04-X1 1 Ct. \$5.66
 CMT.OMM04-X5 5 Ct. \$24.03



2 11/16" Precision Cut, Japan Tothing for Wood

Cutting Width: 1 5/8"
 CMT.OMM06-X1 1 Ct. \$6.54
 CMT.OMM06-X5 5 Ct. \$36.56

All CMT Blades are designed to fit the following Brands:

- Milwaukee
- Rockwell
- Black & Decker
- Rigid
- Skil Bosch
- Multimaster
- Craftsman
- Mastercraft

Contractor Router Bits



Mortising Bit

SKU	D	I	L	Price
CMT.80101	1/2"	1/2"	2"	\$13.25



Pattern Bit

SKU	D	I	L	Price
CMT.81120	1/2"	1"	2 1/16"	\$13.51



Straight Bits

SKU	D	I	L	Price
CMT.81103*	1/8"	5/16"	2"	\$8.22
CMT.81105*	3/16"	1/2"	2"	\$8.76
CMT.81108*	1/4"	5/8"	1 7/8"	\$11.30
CMT.81203	1/4"	5/8"	2 1/2"	\$9.51
CMT.81112	5/16"	1"	2 1/4"	\$10.01
CMT.81115	3/8"	1"	2 3/16"	\$10.15
CMT.81119	1/2"	1"	2 3/16"	\$10.65
CMT.81208	1/2"	1"	2 7/16"	\$10.73
CMT.81208	5/8"	1"	2 3/16"	\$10.73
CMT.81131	3/4"	1"	2 3/16"	\$14.99



Flush Trim Bits

SKU	D	I	L	Price
CMT.80603	3/8"	9/16"	2 3/16"	\$9.94
CMT.80604	1/2"	1"	2 5/8"	\$14.99



Panel Pilot Bit

SKU	D	I	L	Price
CMT.81601	1/4"	3/4"	2 5/8"	\$12.89



Rabbeting Bit Set

SKU	D	I	H	L	Price
CMT.835.001.11	1 1/4"	1/2"	3/8"	2 1/8"	\$53.05



Keyhole Bit

SKU	D	d	I	L	Price
CMT.85001	3/8"	3/16"	7/16"	1 7/8"	\$12.08



Dovetail Bit

SKU	D	I	A	L	Price
CMT.81815	1/2"	1/2"	15°	2 1/16"	\$12.05



Chamfer Bit

SKU	D	I	A	L	Price
CMT.83605	1 3/8"	7/16"	45°	2 3/16"	\$17.16



V-Grooving Bit

SKU	D	I	A	L	Price
CMT.85801	7/16"	9/16"	60°	1 3/4"	\$10.65



Round Nose Bits

SKU	D	I	R	L	Price
CMT.81410	1/4"	3/8"	1/8"	1 1/16"	\$10.65
CMT.81404	1/2"	1/2"	1/4"	1 1/16"	\$11.94
CMT.81412	5/8"	1/2"	5/16"	1 3/4"	\$15.78



Cove & Fillet Bit

SKU	D	I	R	L	Price
CMT.86301	1"	1/2"	3/16"	2 1/8"	\$18.23

All CMT Contractor Tools™ router bits feature:

- Fully heat-treated shank and body for durability
- Anti-kickback design controls the depth of cut
- Made of Sinter hip hi-density carbide
- Corrosion-free black coating
- Precision-ground cutting edges



Cove Bits

SKU	D	I	R	L	Price
CMT.83702	1"	1/2"	1/4"	2 1/8"	\$15.66
CMT.83705	1 1/2"	5/8"	1/2"	2 7/16"	\$18.95



Roundover & Beading Bits

SKU	D	I	R	L	Price
CMT.83802	3/4"	27/64"	1/8"	2 1/16"	\$21.85
CMT.83804	1"	17/32"	1/4"	2 1/8"	\$21.90
CMT.83806	1 1/4"	21/32"	1/4"	2 3/8"	\$18.95
CMT.83807	1 1/2"	3/4"	1/2"	2 3/8"	\$19.95
CMT.83808	1 3/4"	7/8"	5/8"	2 5/8"	\$22.09

Each bit includes a 3/8" bearing for beading profiles



Convex Edge Bit

SKU	D	I	R	L	Price
CMT.85411	1 3/16"	1 1/4"	2 3/32"	2 1/2"	\$18.52



Ovolo Bit

SKU	D	I	R	L	Price
CMT.82706	1"	9/16"	1/4"	1 13/16"	\$14.94



Decorative Ogee Bit

SKU	D	I	R	L	Price
CMT.86508	1 1/32"	5/8"	1/4"	1 7/8"	\$14.23



Roman Ogee Bit

SKU	D	I	R	L	Price
CMT.84001	1 1/8"	1/2"	5/32"	2 1/8"	\$17.52



Ogee Bit

SKU	D	I	R	L	Price
CMT.85902	1 1/2"	5/8"	1/4"	2 1/4"	\$23.52



Ogee Bit

SKU	D	I	R	L	Price
CMT.84103	1 1/8"	1/2"	1/8"	2 1/8"	\$20.66



Bearing Set

Includes: 3/8" bearing, 1/2" bearing, hex key, dust shields, screw
CMT.79101 \$9.90

CMT Hole Saws

Shanks for Hole Saws

CMT.550-HW1 & CMT.550-HW2
CMT.552-DD1 & CMT.552-DD2

SKU	Diameter	Shank Dia.	Each
For Tungsten Carbide-Tipped, Multi-Purpose Saws			
CMT.550-HW1	Up to 1 3/16"	25/64"	\$13.95
CMT.550-HW2	1 1/4" - Above 1/2"		\$14.
For Diamond Dry Hole Saws			
CMT.552-DD1	Up to 1 3/16"	25/64"	\$29.67
CMT.552-DD2	1 1/4" - Above 1/2"		\$29.67

Hole Saws



SKU	Dia.	Cutting No. of Depth	Edges	Each
Multi-Purpose Hole Saws				
CMT.550-025	1"	2 3/64"	1	\$14.37
CMT.550-035	1 3/8"	2 3/64"	1	\$19.14
CMT.550-038	1 1/2"	2 3/64"	2	\$16.80
CMT.550-044	1 3/4"	2 3/64"	2	\$20.63
CMT.550-051	2"	2 3/64"	3	\$21.06
CMT.550-054	2 1/8"	2 3/64"	3	\$25.00
CMT.550-060	2 3/8"	2 3/64"	3	\$25.07
CMT.550-064	2 1/2"	2 3/64"	3	\$25.74
CMT.550-076	3"	2 3/64"	3	\$30.60
CMT.550-092	3 5/8"	2 3/64"	3	\$35.94
CMT.550-105	4 1/8"	2 3/64"	5	\$44.62
Diamond Dry Hole Saws				
CMT.552-006	1/4"	1 3/8"		\$24.85
CMT.552-032	1 1/4"	1 3/8"		\$54.55
CMT.552-035	1 3/8"	1 3/8"		\$59.10

Freud Circular Saw Blades

Each Freud saw blade takes up to 35 manufacturing steps. They're carefully crafted using the best materials, innovative designs, and the most sophisticated manufacturing process. Every product is specifically designed for superior performance and maximum life.

Freud Track saw Blades

Freud's Track saw blades are ideal for festool and are made with Premium TiCo™ HI-Density Carbide Crosscutting Blend for Maximum Performance and a Perma-Shield™ Non-Stick Coating reduces drag and protects the blade.



SKU	Dimensions	Purpose	Price
FT.LU87R006M20	160mm x 14T	Ripping Blade	\$43.54
FT.LU86R006M20	160mm x 28T	General Purpose	\$52.25
FT.LU79R006M20	160mm x 48T	Plywood Blade	\$70.80

Diablo by Freud Contractor Series

Diablo's premium brand of cutting tools are specifically designed for contractors and remodelers and provide superior performance while withstanding the most extreme conditions. Diablo products are manufactured in the world's most technology-advanced facilities to consistently provide high-quality results every time; saving you time and money.



SKU	Type	Teeth	Arbor	Grind	Kerf	Hook	Price
7 1/4" Blades							
FT.D0724X	Framing/Circular Saw	24	5/8"	ATB	.059	15°	\$14.87
FT.D0740X	Finishing/Circular Saw	40	5/8"	ATB	.059	15°	\$22.33
FT.D0760X	Finishing/Panel Saw	60	5/8"	ATB	.059	15°	\$27.36
10" Blades							
FT.D1024X	Ripping/Framing	24	5/8"	ATB	.098	15°	\$39.21
FT.D1040X	General Purpose	40	5/8"	ATB	.098	15°	\$49.55
FT.D1050X	Combination	50	5/8"	ATB	.098	15°	\$51.15
FT.D1060X	Fine Finish	60	5/8"	ATB	.098	15°	\$54.95
FT.D1080X	Ultra Finish	80	5/8"	ATB	.098	15°	\$73.61
FT.D1090X	Ultra Finish	90	5/8"	ATB	.098	15°	\$79.51
12" Blades							
FT.D1260X	Fine Finish	60	1"	ATB	.118	7°	\$57.97
FT.D1280X	Fine Finish	80	1"	ATB	.118	15°	\$78.23
FT.D1296N	Ultra Finish, Laminate	96	1"	TCG	.091	-5°	\$90.49
FT.D12100X	Fine Finish	100	1"	ATB	.118	7°	\$88.86

Freud Dado Blades

Create clean edges, square shoulders, make flat bottom grooves and virtually splinter-free cuts. Features silver I.C.E. coating to prevent build up on the blade surface and to keep the blade running cooler and cleaner. All blades and chippers come with Freud's anti-kick-back design



SKU	Type	Diameter	Teeth	Arbor	Includes	Hook	Price
FT.SD508	Safety Dado	8"	24	5/8"	6 Chippers, 2 Blades	-12°	\$308.81
FT.SD608	Dial-A-Dado	8"	24	5/8"	5 Chippers, 2 Blades, Wrench	-12°	\$411.25

Freud Industrial Blades

Silver Ice Coating (Silver) resists heat 2x longer than uncoated blades.

Perma Shield Coating (Red) resists heat 3x longer than uncoated blades.



SKU	Type	Coating	Teeth	Arbor	Grind	Kerf	Hook	Price
10" Blades								
FT.LM72R010	Rip	Perma Shield	24	5/8"	Flat	.126	20°	\$90.89
FT.LM74M010	Glueline Rip	Silver Ice	30	5/8"	TCG	.118	12°	\$92.72
FT.LM74R010	Glueline Rip	Perma Shield	30	5/8"	TCG	.118	12°	\$100.88
FT.LM75R010	Glueline Rip, Thin Kerf	Perma Shield	30	5/8"	TCG	.091	12°	\$84.56
FT.LU72M010	General Purpose	Silver Ice	40	5/8"	ATB	.126	13°	\$57.97
FT.LU73R010	Cross-Cut	Perma Shield	60	5/8"	ATB	.126	10°	\$108.85
FT.LU74R010	Cross-Cut, Thin Kerf	Perma Shield	80	5/8"	ATB	.098	5°	\$103.85
FT.LU79R010	Plywood/Melamine	Perma Shield	80	5/8"	HI-ATB	.098	2°	\$115.38
FT.LU80R010	Plywood/Melamine	Perma Shield	80	5/8"	HI-ATB	.126	10°	\$133.88
FT.LU82M010	Multi-Purpose	Silver Ice	60	5/8"	TCG	.126	10°	\$109.30
FT.LU83R010	Combination, Thin Kerf	Perma Shield	50	5/8"	COMB	.091	10°	\$81.14
FT.LU84M011	Combination	Silver Ice	50	5/8"	COMB	.126	10°	\$91.73
FT.LU84R011	Combination	Perma Shield	50	5/8"	COMB	.126	10°	\$100.79
FT.LU85R010	Cut-Off	Perma Shield	80	5/8"	ATB	.116	10°	\$127.46
FT.LU87R010	Rip, Thin Kerf	Perma Shield	24	5/8"	ATB	.094	20°	\$62.94
FT.LU88R010	Cross-Cut	Perma Shield	60	5/8"	ATB	.090	15°	\$82.13
FT.LU91R010	Sliding Miter	Perma Shield	60	5/8"	ATB	.090	-5°	\$102.46
FT.LU96R010	Laminate/Melamine Thin Kerf	Perma Shield	80	5/8"	TGC	.091	-3°	\$113.06
FT.LU97M010	Plywood/Melamine	Silver Ice	80	5/8"	TGC	.126	-3°	\$134.19
FT.LU97R010	Plywood/Melamine	Perma Shield	80	5/8"	TGC	.126	-3°	\$148.18
FT.P410	Cross-Cut/Rip	Perma Shield	40	5/8"	Fusion	.126	18°	\$126.78
FT.P410T	Cross-Cut/Rip Thin Kerf	Perma Shield	40	5/8"	Fusion	.091	18°	\$101.40
12" Blades								
FT.LU85R012	Cut-Off	Perma Shield	96	1"	ATB	.116	10°	\$193.46
FT.LU91R012	Sliding Compound Miter Thin Kerf	Perma Shield	72	1"	ATB	.090	-5°	\$129.63
FT.LU97R012	Cut-Off-Ply/Melamine	Perma Shield	96	1"	TCB	.126	-3°	\$175.45

Blade and Bit Cleaner, 18 oz. Bottle

- Increase Tool Life
- Non-Toxic
- Biodegradable
- Non-Flammable

66.TB-18 **\$12.91**



Blades and Bits

Freud Industrial Router Bits

Whether you are a fine woodworker or a high production cabinet shop, one thing is certain: you depend on the best, most precise cutting tools that deliver superior quality finish with long cutting life.

Round Over

SKU	OAD	Radius	Shank	Cut Length	Price
 FT.34-100	5/8"	1/16"	1/4"	1/2"	\$33.67
FT.34-104	3/4"	1/8"	1/4"	1/2"	\$34.13
FT.34-108	7/8"	3/16"	1/4"	1/2"	\$34.77
FT.34-110	1"	1/4"	1/4"	1/2"	\$38.43
FT.34-114	1 1/4"	3/8"	1/4"	5/8"	\$39.21
FT.34-116	1 1/2"	1/2"	1/4"	3/4"	\$46.48
FT.34-124	1 1/4"	3/8"	1/2"	5/8"	\$44.19
FT.34-126	1 1/2"	1/2"	1/2"	3/4"	\$57.05

Flush Trim

SKU	OAD	Shank	Cut Length	Price
 FT.41-502	1/2"	1/4"	2"	\$32.25
FT.42-100	3/8"	1/4"	1"	\$21.03
FT.42-102	3/8"	1/4"	1/2"	\$21.03
FT.42-104	1/2"	1/4"	1"	\$21.03
FT.42-106	1/2"	1/4"	1/2"	\$22.04
FT.42-110	1/2"	1/2"	2"	\$23.75
FT.42-116	1/2"	1/2"	2"	\$37.07
FT.50-102*	1/2"	1/4"	1"	\$30.13

*Top bearing

Chamfer

SKU	OAD	Shank	Cut Length	Price
 FT.40-104	1 11/32"	1/4"	1/2"	\$38.16
FT.40-114	1 3/4"	1/2"	1/2"	\$43.31

Straight

SKU	OAD	Shank	Cut Length	Price
 FT.04-108	1/4"	1/4"	1"	\$20.07
FT.04-124	3/8"	1/4"	1"	\$20.72
FT.04-132	3/4"	1/4"	1"	\$21.68
FT.04-140	3/4"	1/4"	3/4"	\$25.11
FT.12-108	3/8"	1/2"	1"	\$22.69
FT.12-116	1/2"	1/2"	1"	\$22.49
FT.12-118	1/2"	1/2"	1 1/4"	\$22.49

Premier Adjustable Rail & Stile - Two Piece Sets

	FT.99-760	Qtr Round Rail & Stile Long Tenon	\$173.45
	FT.99-761	Ogee Rail & Stile Long Tenon	\$179.62
	FT.99-762	Shaker (bevel) Rail & Style Long Tenon	\$173.59
	FT.99-763	Bead Rail & Stile Long Tenon	\$173.59
	FT.99-764	Bevel Rail & Stile Long Tenon	\$173.59
	FT.54-760	Optional Glass/Screen Panel Cutter	\$50.02

Bits

Freud Tools consistently strives for perfection in cutting tool performance. They meticulously analyze every detail of the woodworker's needs and requirements enabling them to design and produce superior, tailored solutions.



Freud 16pc Forstner Bit Set

Features: Razor-sharp serrated edges give smooth and flat-bottom holes; forged construction for extended life; ultra sharp spur to ensure accurate starting hole. Steep angled cutting edges produce holes that are smooth and flat and create "chisel-like" curls for fast, clean chip removal.

Includes: 16-piece set (1/4"-2 1/8")
FT.PB-100 \$310.47

Freud Forstner Bits

Precision round shank bit. Overall length: 3 1/2"



SKU	Diameter	Price
FT.PB-001	1/4"	10.03
FT.PB-002	3/8"	10.03
FT.PB-003	1/2"	11.55
FT.PB-004	5/8"	13.01
FT.PB-005	3/4"	14.47
FT.PB-006	7/8"	15.88
FT.PB-007	1"	18.76
FT.PB-009	1 1/4"	21.59
FT.PB-010	1 3/8"	26.53
FT.PB-011	1 1/2"	\$32.38
FT.PB-013	1 3/4"	\$36.26
FT.PB-015	2"	\$40.85
FT.FC-010*	1 3/8"	\$53.36

*Carbide bit

**Good for 35mm hinge cup hole



Freud Brad Point Boring Bit

SKU	Description	Price
900.235715	15mm Boring Bit-RH	\$18.71
Freud		
FT.BP10057L	10mm Boring Bit-LH	\$21.93
FT.BP80057L	8mm Boring Bit-LH	\$16.89
FT.BP50057L	5mm Boring Bit-LH	\$13.57
FT.BP50057R	5mm Boring Bit-RH	\$13.57

Hinge Boring Bits for Machines

SKU	Description	Price
900.BB255726	26mm Boring Bit-RH	\$10.29
Freud		
FT.CB32057R	32mm Boring Bit-RH	\$64.30
FT.CB35057R	35mm Boring Bit-RH	\$41.16
FT.CB40057R	40mm Boring Bit-RH	\$67.59



Features:

- Unique cutter geometry to eliminate tearout.
- Top portion of cutter, including bearing and spindle, is removed to produce the front of the long tenon profile.
- TiCo™ Hi-Density Carbide to maximize bit life and material finish.
- Perma-SHIELD® coating reduces heat & pitch build-up from rust.

1/4" (Dia.) Solid Carbide Flush Trim Bit

1/4" Dia x 1/4" Shank x 1/4" H
 Solid micrograin carbide extends the cutting life and the self-piloting feature eliminates the expense/upkeep of a ball bearing assembly. Cuts all plastic laminates.



FT.64-100A Carbide Flush Trim Bit \$7.41



Laminate Tools



Adjustable Length Roller
L.ER-333 18"-27" Long \$39.53



Edge Squeeze Roller
L.SR-79 Squeeze Roller \$19.79



12" J-Roller
L.JR-78 12" Roller \$13.36

L.PC-10F & L.PC-10M



L.PC-10DX

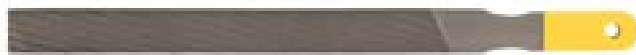

L.SM-10AP



10" Laminate Files

SKU	Type	Case Qty	Price Per Each	
			Each	Case
L.PC-10F	Fast Plasti-Cut	10	\$21.33	\$19.79
L.PC-10M	Mill Plasti-Cut	10	\$15.53	\$14.42
L.PC-10DX	Duplex Plasti-Cut	10	\$20.71	\$19.22
L.SM-10AP	All-Purpose	12	\$16.32	\$15.14

1/4" (Dia.) Solid Carbide Bevel Trim Bit



The solid carbide bit creates a 7-degree bevel and includes a self-piloting feature that eliminates the expense/upkeep of a ball bearing assembly. Cuts all plastic laminates.

FT.66-100A Carbide Bevel Trim Bit \$9.48



Laminate Slitter

Cut laminate or other sheet goods (up to 3/32" thickness) with this handheld, easy to adjust slitter! Make your own edgbanding from any material. Cutting width: 1/2" to 4 1/3"

L.SL-78T Slitter \$164.29
 L.T-78B Replacement Cutter Wheels (2-Pack) \$40.00



Roller Frames

L.RF-3B 3" \$3.86
 L.RF-7B 7" \$4.19
 L.RF-9B 9" \$3.94



Textured Covers

L.RC-3T 3" \$2.51
 L.RC-7T 7" \$4.49
 L.RC-9T 9" \$5.19



Mohair Covers

L.RC-3MR 3" \$2.47
 L.RC-7T 7" \$4.49
 L.RC-9MR 9" \$5.01



Bessey® Clamps

Cabinet Installation Kit



- (2) **BT.BES8511** Face Frame Clamps
- (100) **0.RWSC08300B17** Screws
- (100) **0.RWSC08212B17** Screws
- (100) **0.FCC08212BN17** Screws
- (1) **11.440.22** Square Driver Bit
- (1) **CSH.WG.16** 16oz. Wood Glue

8.CIK Cabinet Installation Kit **\$94.00**

Bessey Auto-Adjust Toggle Clamps



This low-profile toggle clamp auto-adjusts to variations in work piece height from 0-40 mm (approx 1 9/16"). Its base construction is optimized for 1/4" (M6) fasteners, and the spindle has an M8 thread.

SKU	Max*	Price
BT.STC-HH20	1"	\$29.70
BT.STC-HH50	2"	\$31.11

*Maximum material thickness

Bessey Auto-Adjust Inline Toggle Clamp



The Inline Toggle Clamp auto-adjusts to variations in work piece height from 0-16mm (approx 5/8"). Its base construction is optimized for 1/4" (M6) fasteners, and the plunger has an M8 thread. Features a horizontal push pull profile.

SKU	Max*	Price
BT.STC-IHH25	1"	\$33.94

*Maximum material thickness

Bessey Face Frame Clamp w/4" Clamping Capacity



Heavy duty stell clamp with steel sliding T-bars. Use 1/8" bit for pilot hole (not included).

Throat Depth: 2"
Clamping Force: 300-600 lbs.

BT.BES8511 **\$34.19**

Bessey Pipe Clamps



H Style		
BT.BPC-H34	3/4" Black Pipe Diameter	\$22.61
BT.BPC-H12	1/2" Black Pipe Diameter	\$19.30

Traditional Style Features: A large clamping surface, ACME threaded screw, hex head on the spindle.

Traditional Style		
BT.PC34-2	3/4" Black Pipe Diameter	\$21.54
BT.PC12-2	1/2" Black Pipe Diameter	\$18.47

H Style Features: "H" Shape foot assembly stabilizes clamp in two dimensions giving dual-axis stability.

Bessey K Body REVO Parallel Clamp

Wherever high pressure clamping, 90 degree clamping, or powerful spreading is required the new BESSEY® K Body® REVO™ clamp is the ideal tool. With clamping forces up to 1500 lbs., 30% larger clamping surfaces, and sensible accessories this clamp can do the job. The BESSEY® K Body® REVO™ is also suited for accurate adjustment of corners and offset edges.



SKU	Opening	Price
BT.KR3.524	12"	\$65.19
BT.KR3.524	24"	\$70.93
BT.KRE3540	40"	\$82.70
BT.KRE3550	50"	\$85.30
BT.KR3.560	60"	\$94.60
BT.KR3.582	82"	\$113.64
BT.KR3.598	98"	\$105.22

KP Blocks Accessory



Clamp accessory for KR3 and KRV Series, 4 blocks per set

BT.KP **\$29.17**



Jaw Adapter Accessory

Compatible with K Body REVO

BT.KR-AS **\$17.49**



Nail and Staple Guns



GreX Pneumatic 18 Gauge, 1/4" Crown Stapler

Dimensions: 7 3/4" L x 7 1/2" H x 2" W

Operating Pressure: 60 ~ 100 psi

Fastener Range: 3/8" ~ 1 3/8" excluding 1 1/4" (32mm)

Air Inlet: 1/4" NPT male plug

GT.P635

\$198.00



GreX Pneumatic 23 Gauge Headless Pinner With Auto Lock-out

Dimensions: 8 3/4" L x 7 3/4" H x 1 1/2" W

Operating Pressure: 60 ~ 110 psi

Fastener Range: 1/2" ~ 2" excluding 1 1/4"

Air Inlet: 1/4" NPT male plug

GT.P650L

\$298.00



GreX Pneumatic 18 Gauge Brad Nailer

Dimensions: 9 1/2" L x 9 1/4" H x 2" W

Operating Pressure: 70 ~ 120 psi

Fastener Range: 1/2" ~ 2"

Air Inlet: 1/4" NPT male plug

GT.1850GB

\$208.00



GreX Pneumatic 23 Gauge Headless Pinner

Dimensions: 11.5" L x 9" H x 2" W

Operating Pressure: 70 ~ 100 psi

Fastener Range: 3/8" ~ 1-1/4"

Air Inlet: 1/4" NPT male plug

GT.9032

\$138.00



GreX Cordless 18 Gauge Brad Nailer

Dimensions: 10.5" L x 10.3" H x 2.7" W

Requires: (2) AAA alkaline batteries

Battery Capacity: Approx. 50,000 shots per set of batteries

Max Cycle Rate: Approx. 60 shots per minute

Fastener Range: 1/2" ~ 2"

GT.GC1850

\$438.00



Fuel Cells for GreX Cordless Nailer

1,300 Shots per Cartridge.

GT.GFC01-04 4-Pack \$25.00

GT.GFC01-12 12-Pack \$68.00

All GreX staplers & nailers are compatible with Senco fasteners.

Senco Staplers & Nailers



SN.TSL518MG \$102.18

18 Gauge 1/4" Crown Staples

Compatible with **SN.TSNS200XP***

SKU	Length	Qty	Price
SN.SL06BAB	3/8"	10,000	\$29.19
SN.SL08BAB	1/2"	10,000	\$34.36
SN.SL10BABN	5/8"	5,000	\$19.86
SN.SL11BRB	3/4"	5,000	\$18.27
SN.SL12BAB	7/8"	5,000	\$25.16
SN.SL13BRBN	1"	5,000	\$23.45
SN.SL14BRB	1 1/8"	5,000	\$26.74
SN.SL15BRB	1 1/4"	5,000	\$29.81
SN.SL17BAB	1 1/2"	5,000	\$37.56

*Fits most brands of staplers including: Accuset, Atro Minor, Craftsman, DeWalt, DuoFast, Fasco, Hilti, Hitachi, Makita, Porter Cable, and Spotnails.

18 Ga. 1/4 Crown Stapler

Applications: cabinets, soffits, drawer assembly. Features durable metal cylinder, reload indicator, and ultra-light-weight design. Includes wrenches, no-mar pad, case, and plug. Also includes a **five-year warranty**.

Compatible Fasteners

- Type: 18 Ga. 1/4" Crown Medium Wire Staples
- Gauge: 18
- Range: 3/8" - 1 1/2"
- Collation: Glued

17-16 Ga. 7/16" Crown, 2" Heavy Wire Stapler

SN.TSNS200XP \$246.51

*Fits most brands of staplers including: Accuset, Atro, DeWalt, DuoFast, Fasco, Hitachi, Porter Cable, and Spotnails.

16 Gauge 7/16" Crown Staples

Compatible with **SN.TSNS200XP***

SKU	Length	Qty	Price
SN.SN10BAB	5/8"	5,000	\$46.22
SN.SN13BAB	1"	5,000	\$45.65
SN.SN15BRB	1 1/4"	10,000	\$96.26
SN.SN16BRB	1 3/8"	10,000	\$110.02
SN.SN17BRB	1 1/2"	10,000	\$96.53
SN.SN19BRB	1 3/4"	10,000	\$111.12
SN.SN21BRB	2"	10,000	\$125.98



FinishPro 18MG 2 18" Brad Nailer



*Fits most brands of nailers including: Accuset, Atro, Craftsman, DeWalt, DuoFast, Fasco, Hitachi, Makita, Porter Cable, and Spotnails. **Galvanized

Compatible with **SN.TFIP18MG***

SN.TFIP18MG \$113.11

18 Gauge Brads

Brad Nails, AX Series

SKU	Length	Qty	Price
SN.NAX10EAA	5/8"	5,000	\$17.52
SN.NAX11EAA	3/4"	5,000	\$19.00
SN.NAX13EAA	1"	5,000	\$20.60
SN.NAX15EAA	1 1/4"	5,000	\$23.45
SN.NAX17EAA	1 1/2"	5,000	\$27.22
SN.NAX18EAA	1 5/8"	5,000	\$28.29
SN.NAX19EAA	1 3/4"	5,000	\$29.39
SN.NAX21EAA	2"	5,000	\$31.82

Headless Pins

SKU	Length	Qty	Price
SN.NAZ08EAA	1/2"	5,000	\$30.18
SN.NAZ11EAA	3/4"	5,000	\$37.06
SN.NAZ13EAA	1"	5,000	\$40.16

Slight Head Brads, AY Series

SKU	Length	Qty	Price
SN.NAY10EAA	5/8"	5,000	\$35.56
SN.NAY11EAA	3/4"	5,000	\$37.06
SN.NAY13EAA	1"	5,000	\$40.83



SN.TFP16XP \$215.25

16 Gauge Finish Nails, Straight, T-Head

Compatible with **SN.TFP32***

SKU	Length	Qty	Price
SN.NM001001	1"	2,000	\$11.05
SN.NM001002	1 1/4"	2,000	\$11.92
SN.NM001003	1 1/2"	2,000	\$12.79
SN.NM001005	2"	2,000	\$14.54
SN.NM001007	2 1/2"	2,000	\$16.01

Fits most brands of nailers including: Accuset, Atro, Craftsman, DeWalt, DuoFast, Fasco, Hitachi, Makita, Porter Cable, and Spotnails.

FinishPro 16XP, 16 Gauge, Finish Nailer

Range: 1 1/4" to 2 1/2"
Comes with wrenches, tool oil, no-mar pad, case and plug.



FinishPro 42XP, 15 Gauge Finish Nailer 1 1/4 In. - 2 1/2 In.
 SN.TFP42XP \$281.05

15 Gauge Finish Nails, DA Series

Compatible with SN.TFP42XP

SKU	Length	Qty	Price
SN.NDA13EPBN	1"	4,000	\$45.34
SN.NDA15EPBN	1 1/4"	4,000	\$47.92
SN.NDA17EPBN	1 1/2"	4,000	\$49.80
SN.NDA19EPBN	1 3/4"	4,000	\$53.80
SN.NDA21EPBN	2"	4,000	\$56.00
SN.NDA23EPBN	2 1/4"	4,000	\$58.75
SN.NDA25EPB	2 1/2"	3,000	\$48.27

Compressor 1/2 HP, 1 Gal Tank



Oil-less, Draws 4 amps at 115v, CSA-Approved, 20 lbs.
 10.5" H x 14" L x 12.5" W
Standard Equipment: Regulator, Pressure Gauges, 1/4" Coupler, Air Filter

SN.TPC1010 \$199.89

FinishPro 23XP Industrial Strength Headless Pin Nailer

23 Gauge Brads Headless Pins, CZ Series

SKU	Length	Qty	Price
SN.NA100509**	1/2"	2,600	\$12.28
SN.NCZ08EAAN	1/2"	15,500	\$16.85
SN.NA100629**	5/8"	2,600	\$12.73
SN.NCZ10EAAN	5/8"	15,500	\$17.96
SN.NA100759**	3/4"	2,600	\$13.27
SN.NCZ11EAAN	3/4"	15,500	\$19.76
SN.NA101009**	1"	2,600	\$14.15

Compatible with SN.TFP235XP*
 *Fits most brands of nailers including:
 Accuset, Atro, Craftsman, DeWalt, DuoFast,
 Fasco, Hitachi, Makita, Porter Cable, and
 Spotnails.

SN.TFP235XP \$179.89

Cordless Fusion FN65DA 15 GA. Nailer



Weight: 6.2 lbs
 Fastener Capacity: 110
 18v li-ion battery; shots per charge - 600;
 charging time - 80% in 15 min., 100% in 45 min.

Compatible Fasteners
 Type: 15 Ga. 34° Angled Strip Finish Nails
 Gauge: 15
 Range: 1" - 2 1/2"
 Collation: 34° Angled Strip

Compressor 1/2 HP, 1 Gal Tank
 SN.TFN65DA \$495.41



1/4" x 50' Air Hose
 300 PSI with 1/4" Field Repairable Ends
 SN.PC1321 \$53.92

1/4" Hybrid Hose Splicer
 SN.PC1338 \$7.70

1/4" Hybrid Hose Repair End Fitting
 SN.PC1341 \$6.17



with 1/4" Industrial Interchange Plug and Coupler

Air Hose 1/4" x 50'
 SN.TPC0064 \$72.83

Goodyear Rubber Air Hose



50' x 3/8", Red, 250# PSI Working Pressure, Solid Brass 1/4" NPT End Fittings, Class C Weather, Oil, and Solvent Resistant Outer Coating

999.12674 \$33.64

General Finishes®

Water-Based Stains & Paints



Semi-Gel Wiping Wood Stains

Water-based Wood Stains have all the advantages of oil-based stains; they spread easily, can be repaired, blend effortlessly and have plenty of open time.

NEW FINISHES!

Color	Price	Pint SKU	Quart SKU
		\$23.33	\$36.67
Black		GF.WBPT	GF.WBQT
Antique Brown		GF.WAPT	GF.WAQT
Cabernet		GF.WZPT	GF.WZQT
Whitewash		GF.WIPT	GF.WIQT
Black Cherry		GF.WKPT	GF.WKQT
Graystone		GF.WQPT	GF.WQQT
Natural		GF.WNPT	GF.WNQT
Antique Oak		GF.WOPT	GF.WOQT
Pecan		GF.WPPT	GF.WPQT
Graphite		GF.WJPT	GF.WJQT
Hickory		GF.WHPT	GF.WHQT
Walnut		GF.WWPT	GF.WWQT
Espresso		GF.WXPT	GF.WXQT
Brown Mahogany		GF.WYPT	GF.WYQT
Onyx		GF.WFPT	GF.WFQT
Provincial		GF.WVPT	GF.WVQT
Sedona		GF.WSPT	GF.WSQT



Dye Stains

Water-based Dye Stains penetrate deep into the wood to magnify the grain beautifully. Use Dye Stains underneath Wood Stains for intense color combinations!

Color	Price	Pint SKU	Quart SKU
		\$18.33	\$25.83
Amber		GF.DPA	GF.DQA
Blue		GF.DPB	GF.DQB
Cinnamon		GF.DPC	GF.DQC
Dark Brown		GF.DPD	GF.DQD
Ebony		GF.DPE	GF.DQE
Empire Red		GF.DPR	GF.DQR
Light Brown		GF.DPL	GF.DQL
Green		GF.DPG	GF.DQG
Medium Brown		GF.DPM	GF.DQM
Merlot		GF.DPT	GF.DQT
Orange		GF.DPO	GF.DQO
Vintage Cherry		GF.DPV	GF.DQV
Yellow		GF.DPY	GF.DQY
Pewter		GF.DPP	GF.DQP

Exterior 450 Wood Stain

General Finishes' Exterior 450 Stains are premium quality, exterior pigmented stains designed for outdoor projects such as fences, patio furniture, garage doors, entrance doors, outdoor kitchens and interior windows. These outdoor water-based wood stains not recommended for a deck finish. Exterior 450 Stains contain U.V. absorbers to protect the finish and mildewcides to retard mold.



Color	Price	Quart SKU
		\$33.33
Natural Base		GF.QXNB
Butternut		GF.QXB
Chestnut		GF.QXCH
Cedar		GF.QXC
Red Mahogany		GF.QXRM
Coffee Bean		GF.QXCB
Black Walnut		GF.QXWB



Milk Paint

General Finishes Milk Paint is a high quality interior/exterior pre-mixed paint. It is a modern version of old world paint with a strong mineral base.

NEW FINISHES!

Color	Price	Pint SKU	Quart SKU	Gal. SKU
		\$25.00	\$40.00	\$100.00
Alabaster		GF.PA	GF.QA	N/A
Antique White		GF.PAW	GF.QAW	GF.GAW
Snow White		GF.PSW	GF.QSW	GF.GSW
Lamp Black		GF.PLB	GF.QLB	GF.GLB
Linen		GF.PLI	GF.QLI	GF.GLI
Driftwood		GF.PD	GF.QD	GF.GD
Dark Chocolate		GF.PDC	GF.QDC	GF.GDC
Persian Blue		GF.PPB	GF.QPB	N/A
Patina Green		GF.PPG	GF.QTPG	N/A
Basil		GF.PBA	GF.QBA	GF.GBA
Ballet Pink		GF.PBP	GF.QBP	N/A
Queenstown Gray		GF.PQG	GF.QQG	GF.GQG
Seagull Gray		GF.PSG	GF.QSG	GF.GSG
Halcyon Blue		GF.PHB	GF.QHB	N/A
Tuscan Red		GF.PTR	GF.QTR	GF.GATR
Millstone		GF.PMI	GF.QMI	GF.GMI
Coastal Blue		GF.PCB	GF.QCB	N/A
Blue Moon		GF.PBM	GF.QBM	N/A
Holiday Red		GF.PHR	GF.QHR	N/A
Klein Blue		GF.PK	GF.QK	N/A
Sunglow		GF.PS	GF.QS	N/A
Persimmon		GF.PPS	GF.QTPS	N/A
Coral Crush		GF.PCC	GF.QCC	N/A
Emerald		GF.PE	GF.QE	N/A
China Blue		GF.PCHB	GF.QCHB	N/A
Gulf Stream Blue		GF.PGS	GF.QGS	N/A
Empire Gray		GF.PEG	GF.QEG	N/A
Harvest Yellow		GF.PHY	GF.QHY	N/A
Key West Blue		GF.PTKW	GF.QTKW	N/A
Perfect Gray		GF.PPGY	GF.QPGY	N/A
Reverent Gray		GF.PRGY	GF.QRGY	N/A
Twilight		GF.PT	GF.QT	N/A
Westminster Green		GF.PWGR	GF.QWGR	N/A

Enduro Ready-to-Match Stain System

NEW PRODUCTS!

General Finishes RTM (Ready-to-Match) stain system is a water-based color matching system designed to give you (the cabinet-making professional) the flexibility to turn ten base concentrates into an endless color pallet of rich wood tones using simple prescribed formulas. Purchase the Ready-to-Match Color Chip Box to give your customers the ability to choose from 150 custom colors. After the choice has been made, use the formula on the color chip to mix the concentrated colors (sold individually) into the exact cabinet finish your customer desires.



Ready-to-Match Stain System Color Chips

Purchase the Ready-to-Match Color Chip Box to give your customers the ability to choose from 150 custom colors.

SKU	Type	Price
GF.CBL	With Lid	\$592.92
GF.CB	Without Lid	\$350.00

Ready-to-Match Water-Based Stains

General Finishes Ready To Match (RTM) Stain System is a water-based stain color-matching system that consists of 11 standard stain bases and a clear that are intermixed to make 150 rich, deep wood stain colors.

Color	Gallon SKU	Price
Bordeaux	GF.GBD	\$75.00
Burnt Umber	GF.GBU	\$75.00
Golden Brown	GF.GGB	\$75.00
Red	GF.GRED	\$75.00
Raw Sienna	GF.GRS	\$75.00
Raw Umber	GF.GRU	\$75.00
Tint Base Black	GF.GTB	\$75.00
Tint Base Clear	GF.GTBC	\$46.67
Trans Red	GF.GTR	\$75.00
Tavern Brown	GF.GTV	\$63.24
Tint Base White	GF.GTW	\$75.00

Oil-Based Stains & Top Coats



Gel Stain

Home of the popular Java Gel stain that has been featured across social media for upcycling furniture and cabinets. Gel Stains are heavy-bodied and do not penetrate as deeply into the wood as liquid oil-based stains do, providing the deepest, richest colors of any oil-based stain available.

Color	Price	Pint SKU	Quart SKU
		Starting at \$23.33	Starting at \$38.33
New Pine		GF.NPP	GF.NPQ
Prairie Wheat		GF.PP	GF.PQ
Ash Gray		GF.APT	GF.AQT
Colonial Maple		GF.CMP	GF.CMQ
American Oak		GF.OP	GF.OQ
Antique Walnut		GF.AP	GF.AQ
Black		GF.BLP	GF.BLQ
Candlelite		GF.CP	GF.CQ
Brown Mahogany		GF.BP	GF.BQ
Georgian Cherry		GF.GCP	GF.GCQ
Gray		GF.GRP	GF.GRQ
Nutmeg		GF.NP	GF.NQ
Carbon Gray		GF.CPT	GF.CQT
White		GF.WPT	GF.WQA

Color	Price	Pint SKU	Quart SKU
Java		\$28.33	\$48.33
		GF.JP	GF.JQ



Glazes

Glaze Effects are translucent water-based colors used to create beautiful decorative finishes such as marbling, shabby chic, burnishing and color washing. Use with milk paint to give an antique or two-tone look to your project!

Color	Price	Pint SKU	Quart SKU
Pitch Black		GF.PTPB	GF.QTPB
Van Dyke Brown		GF.PTVDB	GF.QTVDB
Burnt Umber		GF.PTBU	GF.QTBU
Clear Base		GF.PTCB	GF.QTCB

Water-Based Top Coats & Undercoats



High Performance Polyurethane Top Coat

Winner of Fine Woodworking's Best Overall Choice Award, High Performance Topcoat was voted as the hardest, most durable consumer polyurethane topcoat.

Type	Price	Quart SKU	Gallon SKU	5-Gallon
Flat		GF.QTHF	GF.GAHF	GF.5GHF
Satin		GF.QTHS	GF.GAHS	GF.5GHS
Semi-Gloss		GF.QTHSG	GF.GAHSG	N/A
Gloss		GF.QTHG	GF.GAHG	N/A



Enduro Var Water-Based Urethane Varnish

Enduro-Var is a self cross-linking polyurethane that looks more like an oil varnish than a water coating. It ambers slightly, is highly water resistant, and is both sprayable and brushable.

Type	Qt. SKU	Qt. Price	Gal. SKU	Gal. Price
Flat	GF.QVF.II	\$46.12	GF.GVF	\$110.68
Satin	GF.QVS.II	\$46.12	GF.GVS	\$110.68
Semi-Gloss	GF.QVSG.II	\$46.12	GF.GVSG	\$110.68
Gloss	GF.QVG.II	\$46.12	GF.GVG	\$110.68



Enduro Water-Based Clear Poly Top Coat

Enduro Clear Poly is a high performing commercial grade topcoat fortified with polyurethane that delivers a very tough and abrasion-resistant finish. Spray Only.

Type	Price	Quart SKU	Gallon SKU	5-Gallon
Flat		N/A	GF.GPF	N/A
Satin		GF.QPS	GF.GPS	GF.5PS
Semi-Gloss		N/A	GF.GPSG	N/A
Gloss		N/A	GF.GPG	N/A



Flat Out Flat Acrylic Top Coat

FOF is a truly "Flat" water-based topcoat with a velvety look and feel. Made with a durable, self cross-linking acrylic, its performance characteristics are similar to High Performance.

SKU	Type	Size	Price
GF.QFO	Acrylic Top Coat	Quart	\$38.33
GF.GFO	Acrylic Top Coat	Gallon	\$100.00



Exterior 450 Clear Varnish

Exterior 450 provides a clear-drying, tough, protective finish that will withstand the rigors of the sun, rain, and wind. It is suitable for vertical surfaces such as fences, patio furniture, garage doors, and more.

Application:

Use an acrylic brush, foam brush, paint pad applicator, or spray. Apply a minimum of 3 coats for best results.

Type	Price	Qt. SKU	Gal. SKU	5-Gal. SKU
Flat		GF.QXF	GF.GXF	N/A
Satin		GF.QXS	GF.GXS	N/A
Semi-Gloss		GF.QXSG	GF.GXSG	GF.5XSG
Gloss		GF.QXG	GF.GXG	N/A



NEW PRODUCT!

Brushable White Enamel

Brushable White Enamel is a premium, pigmented water-based wood enamel ideal for cabinets, furniture and millwork. Acting as a 2-in-1 paint and topcoat, this enamel is perfect for those who want to work with Enduro White Poly, but do not own a spray gun.

Type	Price	Qt. SKU	Gal. SKU
Satin		GF.QES	GF.GES
Semi-Gloss		GF.QESG	GF.GESG



Stain Blocker White Primer

Stain Blocker is GF's new water-based white primer. GFSPB can be used to protect pigmented finishes from stain, dye and wood tannin bleed-through.

SKU	Type	Size	Price
GF.QSB	White Primer	Quart	\$50.00
GF.GSB	White Primer	Gallon	\$133.33



Enduro Water Based Sanding Sealer Undercoat

Enduro Water-Base Sanding Sealer is a clear undercoat that forms an easily sandable foundation for your project.

Type	Quart SKU	Quart Price	Gallon SKU	Gallon Price
Clear	GF.SSSS	\$22.73	GF.SSS1	\$78.33



Arm-R-Seal Urethane Top Coat

Arm-R-Seal topcoats are made with only the highest quality urethane resin, making them extremely durable and long lasting.

Type	Price	Qt. SKU	Gal. SKU
Satin		GF.ASQT	GF.ASGA
Semi-Gloss		GF.SGQT	GF.SGGA
Gloss		GF.AGQT	GF.AGGA



Satin Gel Oil-Based Top Coat

The Satin Gel Topcoat is a heavy duty oil and urethane oil-base top coat, which produces a beautiful hand-rubbed quality finish.

SKU	Type	Size	Price
GF.SQ	Gel Topcoat, Satin	Quart	\$38.33
GF.SG	Gel Topcoat, Satin	Gallon	\$90.00



Wood Products



White Poly

A very durable topcoat as an alternative to white paint. Recommend for use with spray-on application.

SKU	Type	Size	Price
GF.GWS	Satin Poly	Gallon	\$116.67
GF.GWSG	Semi-Gloss Poly	Gallon	\$116.67
GF.5GWS	Satin Poly	5-Gallon	\$483.33
GF.5GWSG	Semi-Gloss Poly	5-Gallon	\$365.63

Pre Cat Lacquer



General Finishes water-based Pre-Cat Lacquer has a novel formula that produces a smaller and smoother polymer particle, which translates into a big increase in film clarity.

SKU	Type	Size	Price
GF.GPCG	Gloss	Gallon	\$100.00
GF.GPCF	Flat	Gallon	\$100.00
GF.GPCS	Satin	Gallon	\$100.00
GF.GPCSG	Semi-Gloss	Gallon	\$100.00

Accessories

Brush & Gun Cleaner (Gallon)

Keep your spray gun operating at peak performance with Brush and Gun Cleaner. For use with water-based products.

GF.BGGA \$58.33



Extender

Extender is a wetting additive used to improve flow and leveling, and increase the drying time of any water-based stain, topcoat or glaze, which is helpful in hot, dry conditions. May be used with all General Finishes water-based products.

GF.EXPT 16 oz. \$15.83

GF.EX4 4 oz. \$7.41



Accelerator, 16 oz. (Pint)

Accelerator is an additive that decreases dry time of General Finishes water-based products, which is helpful in humid conditions where dry time is normally extended. For General Finishes water-based wood finishes.

GF.PTAC \$15.83



Wood Treatments

Wood Treatments

Pentacryl Green Wood Stabilizer



Pentacryl is a wood stabilizer that keeps green wood from cracking, checking and splitting during the drying process.

SKU	Size	Price
PS.QT50PENT	Quart	\$23.95
PS.GAL50PENT	Gallon	\$72.95

End Grain Sealer



End Grain Sealer is a non-toxic wax emulsion to be applied to the end grain of green wood or the face grain of turning blanks or carvings.

SKU	Size	Price
PS.QT50PENT	Quart	\$23.95
PS.GAL50PENT	Gallon	\$72.95

Graffiti Remover, Quart

Blue Bear Concrete Treatments



Safely removes unwanted graffiti, marker, and other "tags" from hard or porous surfaces. For indoor or outdoor applications.

SKU	Surface	Price
BB.BBRPSQTEANDT1	Porous	\$26.95
BB.BBRHSQTEANDT1	Hard	\$21.95

Mastic and Adhesive Remover for Concrete



An effective green choice to easily remove old black mastics under tiles and glues and adhesives under carpet.

SKU	Size	Price
BB.BBRM1QTEANDT1	Quart	\$13.95
BB.BBRM1GEANDT1	Gallon	\$35.95

Wood Juice Dry Wood Stabilizer



This wood stabilizer is formulated for use on dry or semi-dry wood to prevent future cracking and splitting.

PS.QT50WJ	Quart	\$23.95
PS.GAL50WJ	Gallon	\$72.95

Polycryl Wood Fortifier



A concentrated, high molecular weight acrylic polymer that will fill and strengthen soft, spalted or punky wood and it dries clear.

PS.QT50POLY	Quart	\$21.95
PS.GAL50POLY	Gallon	\$65.95

Cleaner and Degreaser Concentrate



Easily clean grime, oils and grease from surfaces such as asphalt, concrete, metal and painted walls. Excellent as a follow up to Paint Strippers and Mastic Remover.

SKU	Size	Price
BB.BBRDFQTEANDT1	Quart	\$10.95
BB.BBRDF1GEANDT1	Gallon	\$27.95

Paint & Urethane Stripper



This paint and urethane stripper effectively removes multiple layers of paint, varnish, enamel, urethane, and lead based paint safely by encapsulating it in gel.

SKU	Size	Price
BB.BBRSGQTEANDT1	Quart	\$21.95
BB.BBRSG1GEANDT1	Gallon	\$67.95

Wood Items, Fillers & Stain Markers

Wood Restoration



Cutting Board Oil, 12 oz.

Our Cutting Board Oil meets FDA requirements for food contact surfaces, and is safe for all food preparation surfaces. It is tasteless, and will never go rancid.

HW.BBB012 \$9.66



Butcher Block Conditioner, 12 oz.

The penetrating quality of food-grade mineral oil along with the water-resistant traits of beeswax and carnauba wax rejuvenates the wood and prevents drying and cracking.

HW.BBC012 \$10.90



Feed-N-Wax Wood Polish & Conditioner

Feed-N-Wax is a special blend of beeswax, carnauba wax, and orange oil. It enhances the natural beauty and depth of grain in finished and unfinished wood.

HW.FW0008 8 oz. \$6.39

HW.FW0016 16 oz. \$10.33



Restor-A-Finish

Restor-A-Finish is a unique finish-penetrating formula that restores the original color and luster to your finish while blending out the blemishes and minor scratches.

SKU	Size	Finish	Each
HW.RF1008	8 oz.	Neutral	\$7.49
HW.RF1016	16 oz.	Neutral	\$10.99
HW.RF2008	8 oz.	Maple-Pine	\$7.49
HW.RF2016	16 oz.	Maple-Pine	\$10.99
HW.RF3008	8 oz.	Golden Oak	\$8.05
HW.RF3016	16 oz.	Golden Oak	\$10.99
HW.RF4008	8 oz.	Walnut	\$7.49
HW.RF4016	16 oz.	Walnut	\$10.99
HW.RF5008	8 oz.	Mahogany	\$8.05
HW.RF5016	16 oz.	Mahogany	\$10.99
HW.RF6008	8 oz.	Dark Walnut	\$8.05
HW.RF6016	16 oz.	Dark Walnut	\$10.99
HW.RF7008	8 oz.	Dark Oak	\$7.49
HW.RF7016	16 oz.	Dark Oak	\$10.99
HW.RF8008	8 oz.	Ebony Brown	\$7.49
HW.RF8016	16 oz.	Ebony Brown	\$10.99
HW.RF9008	8 oz.	Cherry	\$7.49
HW.RF9016	16 oz.	Cherry	\$10.99



Orange Oil Wood Polish

Natural orange essence oil is derived from orange rinds and has excellent cleaning properties. These naturally occurring cleaners replace the need for harsh chemicals.

HW.OR0008 8 oz. \$7.99

HW.OR5016 16 oz. \$10.99



WoodEpoX Kit

WoodEpoX bonds permanently with high strength to most surfaces. It fills cracks, holes, and voids of any size without the shrinking and crumbling of common wood fillers.

AI.WEAB6OR 12 Ounces \$24.95

AI.WE2PKR 2 Pints \$49.75

AI.WE2QKR 2 Quarts \$79.90

AI.WE2GKR 2 Gallons \$199.50



LiquidWood Kit

LiquidWood is ideal for regenerating and waterproofing rotted, dried-out or spongy window sills, window and door frames, columns, stair steps, moldings, doors, boats, and more! LiquidWood is also a primer for WoodEpoX.

AI.LWAB6OR 12 Fl. Ounces \$27.75

AI.LW2PKR 2 Pints \$55.75

AI.LW2QKR 2 Quarts \$89.90

AI.LW2GKR 2 Gallons \$229.90

Wood Restoration Kit



LiquidWood reinforces, rebuilds and waterproofs wood by hardening after penetrating. Regenerates rotted structural and decorative parts. Wood-

EpoX is a structural adhesive putty. It is the most versatile, high-strength, no-shrink adhesive paste to fill, repair and replace wood and other materials in structures, walls, and more.

Includes 2 Qt. Liquid Wood & 2 Qt. Wood EpoX

AI.WR4QKR 1 Fl. Gallon \$157.95

Includes 12 Oz. Liquid Wood & 12 Oz. Wood EpoX

AI.WRK6OR 24 Fl. Ounces \$49.75

Concrete Restoration



Aboweld

Fill cracks, replace missing concrete, and permanently bond concrete and most rigid materials. Restore columns, walls, ceilings, foundations, pools, rails, stair, risers and treads, sculptures, and more. Also great for installing machinery, posts, precasts, and other structural components.

AI.5512QKR \$81.10



Abocrete

Repairs plant floors, loading docks, sidewalks, driveways, stairs, parking decks, and ship docks

permanently and cost-effectively. Perfect for fixing pitted, spalled, worn or cracked concrete.

AI.ACKSR-LG \$48.85



Krack Kote

Make invisible, permanent repairs to cracked walls and ceilings. Krack Kote can be used on drywall, plaster, stucco, wood, concrete, and cement block

AI.KRACK \$19.90



NEW

Tread Spread Slip-Resistant Epoxy Coating, Slate Gray

Tread Spread is a spreadable epoxy coating that includes a slip-resistant aggregate. Simply mix and spread wherever additional traction is needed. Bonds tenaciously to concrete, wood, metal, fiberglass, and most rigid surfaces. Use on wet, dry, and underwater surfaces. High-traction and easy to apply. Much more durable and long lasting than tapes. Exceeds OSHA and ADA recommendations for slip resistance in both wet and dry conditions. Coverage is 12 square feet x 1/8" thickness per gallon.

AI.TS2PK-PD 2 Pints \$49.50

AI.TS2GK-PD 2 Gallons \$197.90

Genuine Lamello Biscuits, Beech Wood

Precision Made; Consistent Size & Thickness.

SKU	Size	Price per 1,000		
		100-ct	Case Qty	1,000 Case
LB.0	#0	\$5.90	9,000	\$53.00 \$49.00
LB.10	#10	\$5.40	6,500	\$50.00 \$45.00
LB.20	#20	\$6.00	5,000	\$55.00 \$51.00

Economy Biscuits, Beech Wood

SKU	Size	Price per 1,000-ct	
		100-ct	1,000-ct
60.00	#0	\$5.50	\$45.80
60.10	#10	\$7.10	\$59.00
60.20	#20	\$7.10	\$59.00



Lamello Classic X Biscuit Joiner

- Fully revised base plate, a slim yet powerful 780 W motor.
- Lateral tolerance allows for faster working without positioning aids and stops.
- Quick adjustments for 6 cutting depths.
- Multifunctional stop square for vertical stability as well as perfect mitres due to the application on the outer surface for 22.5° and 45° angles.
- Central locking for quick change of cutter.

L.101600K Lamello Biscuit Joiner \$799.00

Wood Fillers



FastCap

FastCap SoftWax Filler System

SoftWax is a great way to fill holes in finished woodwork. The refillable kit* comes with 20 blendable colors, a Wax-Wedge and a buffering pad. The hard shell case keeps the wax where you want it.

SKU	Description	Each
FC.WAXKIT.20S	SoftWax Kit	\$42.59
FC.WAX11SR	Refill, Red	\$2.66
FC.WAX13SY	Refill, Yellow	\$2.66
FC.WAX12SG	Refill, Green	\$2.66
FC.WAXWEDGE	WaxWedge Refill	\$1.34
FC.WAXPAD	Buffing Pad Refill	\$1.34

Wood Products



Wood-Tex Wood Filler

In addition to being waterproof, it is fast setting, molds like putty, & has minimum shrinkage. **A great solution if you need a thinner solvent.** 12 per case.

Price per Each

SKU	Colors	Each	Case
65.8.0	Natural	\$7.75	\$6.91
65.8.4	Red Oak	\$7.16	\$6.65
65.8.10	Maple	\$7.75	\$6.91
65.8.13	Dk Mah Cherry	\$4.59	\$4.24

Famowood Water-Based, Solvent-Free Wood Filler



*Please add the SKU Code (from the table) to the end of your SKU in order to indicate your color preference. Not all colors are available in all sizes.

Code	Colors	Code	Colors
.0	Natural	.6	Walnut
.01	White	.8	Oak
.3	Birch	.10	Maple
.4	Red Oak	.13	Cher/Dk Mahogany
.5	White Pine	.14	Golden Oak

Famowood Latex Wood Filler has the same outstanding qualities of Original Famowood, but has very low odor and can be cleaned up with water!

Price per Each

SKU	Size	Case Qty	Each	Case
63.32*	1/4 Pint	12	\$3.49	\$3.11
63.8*	Pint	12	\$6.95	\$6.11
63.1*	Gallon	2	\$39.38	\$35.27

Famowood Solvent-Based Wood Filler



*Please add the SKU Code (from the table) to the end of your SKU in order to indicate your color preference (price is based on "Natural" Wood Filler).

Code	Colors	Code	Colors
.0	Natural	.9	Cedar
.2	Ash	.10	Maple
.3	Birch	.11	Mahogany
.4	Red Oak	.13	Cherry
.5	White Pine	.15	Alder
.6	Walnut	.16	Fir
.8	Oak		

With Famowood Original Wood Filler, it doesn't matter whether you are masking small or large defects, Famowood can handle the job. It spreads smoothly into cracks and holes, takes stains and paints evenly and resists cracking.

Price per Each

SKU	Size	Case Qty	Each	Case
64.32*	1/4 Pint	12	\$3.16	\$2.91
64.8*	Pint	12	\$7.65	\$6.82
64.4*	Quart	12	\$12.86	\$7.70



Pocket Putty Knife

This compact Putty Knife is great for use around the house or on the job. Put safety first by using this foldable versatile tool.

FC.PPF \$14.52



Pocket Combo Putty Knife

This compact Combo Putty Knife is a scraper, putty knife, crack opener, grout cleaner & paint roller cleaner all in one!

FC.PCP \$14.65

Famowood Glaze Coat Clear Epoxy Kit

Famowood Glaze Coat is a pour-on epoxy coating that can be used on most surfaces - rough or smooth, stained or painted. It's great for coating tables or bar tops, preserving photographs or imbedding decorative items.



64.5050060	Pint	\$16.77
64.5050080	Quart	\$28.71
64.5050110	Gallon	\$78.77



Perfect Match Stain Markers

66.PMSM-01	Single Stain Marker	\$4.49
66.PMSM-04	4 Pack of Stain Markers	\$14.19



Nib Holder with 5 Chisel Tips

66.PMSM-05 \$1.49



15 Chisel Tips Replacements

66.PMSM-07 \$2.69



Nib Holder with 5 Assorted Tips

66.PMSM-06 \$1.49

Plugs, Dowels & Pegs

Finish your current woodworking project with the help of premium wood items and fillers from Custom Service Hardware. Whatever your woodworking project is, we have the hardware you'll need.

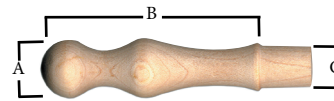

Mug Peg, Birch

A: 3/4", B: 2 7/8", C: 1/2"

SKU	Price per Each		
	Each	100	250
60.724	\$.48	\$.40	\$.35

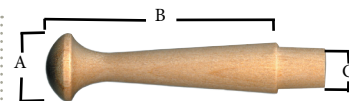

Peg Shaker, Hardwood

A: 7/8", B: 2 7/8", C: 1/2"

SKU	Price per Each		
	Each	100	250
60.728	\$.46	\$.37	\$.31

Fluted Dowels



SKU	Dia.	Length	Price per 1,000			
			100	1,000	5,000	Case Qty Case
60.P0830.1	8mm	30mm	\$2.20	\$17.00	\$13.00	19,200 \$11.00
60.P0835.1	8mm	35mm	\$2.40	\$18.00	\$15.00	16,400 \$12.00
60.P0310.1	3/8"	1 1/4"	\$2.60	\$20.00	\$16.00	23,000 \$13.00
60.P0312.1	3/8"	1 1/2"	\$3.00	\$22.00	\$18.00	13,000 \$15.00
60.P0316.1	3/8"	2"	\$4.00	\$30.00	\$24.00	13,000 \$20.00
60.P0210.1	1/4"	1 1/4"	\$2.30	\$17.50	\$14.50	29,600 \$12.80

Pre-Glued Dowels also available with a 5,000 minimum order

Buttons



SKU	Shank	Top Size	Type	Price per 1,000			
				100	1,000	5,000	25,000
60.0304.1	3/8"	1/2"	Birch	\$3.23	\$25.00	\$20.60	\$17.40
60.0304.2	3/8"	1/2"	Oak	\$4.03	\$26.85	\$22.42	\$20.66
60.0405.1	1/2"	5/8"	Birch	\$3.63	\$33.00	\$30.20	\$25.90
60.0405.2	1/2"	5/8"	Oak	\$5.12	\$34.07	\$28.44	\$26.23

Plugs



SKU	Size	Description	Price per 1,000			
			Each	1,000	5,000	25,000
60.0300.1	3/8"	Flat Head, Birch	\$2.20	\$20.00	\$16.00	\$14.00
60.0400.1	1/2"	Flat Head, Birch	\$2.60	\$23.00	\$19.00	\$16.00
60.0300.2	3/8"	Flat Head, Oak	\$3.90	\$36.00	\$30.00	\$25.00
60.0038.2	3/8"	Round Head, Oak	\$3.90	\$35.00	\$28.00	\$24.00

Spaceballs & Synergy Panel Spacers

Ball Insertion Gun

Compatibility Information

- Works with .260" & .232" Space Balls or Synergy Spacers
- Works in grooves down to .210"

It's faster

Just pull the trigger and a ball is inserted!

It's friendlier

New ergonomic design means less fatigue & more productivity.

Instantly neater

Balls end up in your **door**, not on the **floor**!



Features:

- Easily and accurately insert balls into your doors
- Pneumatic action is easy on your door's surface
- Every pull of the trigger inserts a ball right where you need it
- Replacement parts available, call for details

SP.EZBALL	Spaceball Insertion Gun	\$328.90
SP.EZBALL.CH	Spaceball Insertion Gun w/ Coiled Hose	\$350.90
SP.STAND	Stand w/ Coiled Hose	\$13.20
SP.COILHOSE	10' Coiled Air Hose	\$33.00
SP.TALC.O8	8 oz Bottle of Talc	\$4.40
EZ.TALC-50#BAG	50 Lb Bag of Talc	\$207.90

6 month limited warranty!

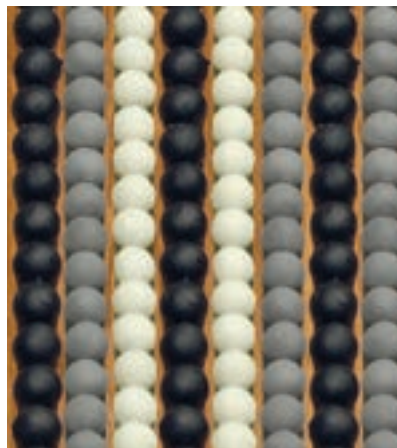

Spaceballs

SKU	Description	Price Per Thousand			
		1,000	10,000	25,000	50,000
SP.BALLS.190	.190 Dia. (Black)	\$22.90	\$16.40	\$14.90	\$12.50
SP.BALLS.210	.210 Dia. (Grey)	\$22.90	\$16.40	\$14.90	\$12.50
SP.BALLS.232	.232 Dia. (White)	\$22.90	\$16.40	\$14.90	\$12.50
SP.BALLS.26S	.260 Dia. Soft (Black)	\$22.90	\$19.40	\$17.20	\$15.60
SP.BALLS.26H	.260 Dia. Hard (Black)	\$22.90	\$16.40	\$14.90	\$12.50

For larger quantities, please call for quote

For pricing or product inquiries, just give us a call! Free samples available.



Synergy Spacer



Tube-Its

Panel Spacers

- 100% Green
- No oil
- No phthalates
- No Talc needed



SKU	Description	Price Per 1,000			
		1,000	10,000	20,000	40,000
SY.5MM	Green - Synergy Spacer .245 Dia	\$15.00	\$14.50	\$14.00	\$13.00
SY.250	Orange - Synergy Spacer .265 Dia	\$16.00	\$15.00	\$14.50	\$13.50
SY.270	Yellow - Synergy Spacer .270 Dia	\$15.00	\$14.50	\$14.00	\$13.00
JBL.TUBE-ITS.519G	Tube-Its #519-G (soft) .265	\$20.40	\$18.60	\$17.00	\$15.80
JBL.TUBE-ITS.529G	Tube-Its #529-G (soft) .229	\$17.00	\$15.50	\$14.50	\$13.30

Free samples available

SPACEBALLS&SYNERGY PANEL SPACERS

Kitchen Accessories

Fillers & Pullouts

Stackable, Pantry-Filler Pullout Organizer with Adjustable Shelves



Four Units (Two on Each Side) in the Above Display



Create a pantry behind those decorative panels with these Tall 432 fillers. Available for 6" applications, the 432TF Series comes in 39" and 45" heights and can be used alone or in conjunction with others to meet your 84", 90", or 96" height requirements. A beautiful addition to any kitchen; each unit features adjustable shelves (5 for the 39", and 6 for the 45") with chrome rails.

Features:

- 6" Wide Filler Pullout
- (5) Adjustable shelves for the 39" H pullout
- (6) Adjustable shelves for the 45" H pullout
- Limited lifetime manufacturer warranty
- Simply add your own cabinet front
- Stack 2 together for taller applications
- Comes ready to be installed (with new cabinet installation only)
- NOTE: This product ships truckline

R.432.TF39.6C 39"H x 6"W x 23" D **\$326.29**

R.432.TF45.6C 45"H x 6"W x 23" D **\$351.36**



11-1/8" Deep Wall Filler Organizer

Don't waste valuable space in your kitchen—transform a decorative filler in your cabinets into a useful storage pullout!

R.432.WF.3C-30 3" W x 30" H **\$102.10**

R.432.WF.6C-20 6" W x 30" H **\$148.05**

R.432.WF36.3C 3" W x 36" H **\$150.98**

R.432.WF36.6C 6" W x 36" H **\$175.22**

R.432.WF42.3C 3" W x 42" H **\$165.98**

R.432.WF42.6C 6" W x 42" H **\$194.90**



Base Cabinet Filler

Add more storage space behind those decorative fillers between your cabinets! 23" D x 30" H.

R.432.BF.3C-24 3" W **\$128.99**

R.432.BF.6C-18 6" W **\$197.50**

R.432.BF.9C 9" W **\$338.73**



Base Cabinet Filler w/Soft-Close, Ball Bearing Slides

23 1/4" D x 30 1/4" H

R.432.BFBSC.3C 3" W **\$193.34**

R.432.BFBSC.6C 6" W **\$269.01**



Wall Cabinet Pullout Shelving Organizer with Soft-Close

Designed for 9" and 12" wall cabinets, our 448 Series is now available for full access cabinets, and with a new face frame version designed for 36" wall cabinets, you are sure to find the perfect solution for your kitchen organization needs. This pullout features natural maple construction, full-extension ball-bearing 100 lb.-rated slides with soft-close, and either four or five shelves with chrome wire accents. Precise door alignment is easy with our patented door mount brackets with micro-adjustment.

- Adjustable shelves with chrome rails
- Full-extension, ball-bearing, soft-close drawer slides
- Includes rub bushings for increased vertical stability
- Carb II compliant
- Patented door mount brackets with micro-adjustment for up to 5" of adjustability for various door styles

10.75" Depth x 32.19" Height

R.448.BBSCWC36.5C 5" W Pullout for Face Frame Wall 9" for 36"+ Height Cabinets **\$178.97**

R.448.BBSCWC36.8C 8" W Pullout for Face Frame Wall 12" for 36"+ Height Cabinets **\$225.18**

10.75" Depth x 26.19" Height

R.448.BBSCWC.6C 6.5" W Pullout for Full Access Wall 9" for 30"+ Height Cabinets **\$167.54**

R.448.BBSCWC.9C 9.5" W Pullout for Full Access Wall 12" for 30"+ Height Cabinets **\$197.27**

Cabinet Pull-Down Solid Bottom Shelving System



Tired of reaching for the step ladder to access your cabinets? We have the solution with our solid bottom pulldown shelving system designed specifically to bring things out and down from the cabinet. This ingenious accessory is easy to operate and holds up to 26 lbs.

- Two solid bottom shelves, walnut
- Built for 24" or 36" wall cabinets (specified below)
- Pulls down 11.5" and out 16.75"
- Mounts to cabinet floor and side walls
- Gas assisted lifting/lowering mechanism

R.5PD.24FOG 24" 22.25" W x 10.13" D x 18.38" H **\$429.99**

R.5PD.36FOG 36" 34" W x 10.13" D x 18.38" H **\$469.99**



Base Pullout Organizer

Designed for full height base cabinets, these beautiful organizers feature adjustable shelves with chrome rails to help keep everything in its place. Pictured with optional spice rack insert. 22 1/2" D x 25 1/2" H

R.448.BC.5C-28 5" W **\$168.99**

R.448.BC.6C 6 1/2" W **\$207.06**

R.448.BC.8C-16 8" W **\$199.99**

R.448.BC.11C 11" W **\$308.17**

R.448.BC.14C 14" W **\$370.76**



Base Cabinet Filler

The Filler Organizer with Blum Soft-Close slides. Adjustable shelves with chrome-finished rails. 23" D x 30" H.

R.432.BFSC.3C 3" W **\$261.69**

R.432.BFSC.6C 6" W **\$313.94**

R.432.BFSC.9C 9" W **\$371.22**



Wall Pullout Organizer

This wall pullout features adjustable shelves with chrome rails. 10 3/4" D x 26 1/4" H

R.448.WC.5C 5" W **\$132.68**

R.448.WC.8C 8" W **\$155.28**



Base Pullout Organizer w/ Soft-Close, Ball-Bearing Slides

These base organizers glide effortlessly on our patented soft-close "tri-slides" which minimize any side-to-side motion and provide complete stability when pulled out of the cabinet. An adjustable rear wall prevents items falling behind the pullout and door mounting is easy with our patented door mount brackets. 21 3/4" D x 25 1/2" - 29 1/2" H.

- R.448.BCBBSC.5C 5" W \$240.55
- R.448.BCBBSC.8C 8" W \$262.61



Soft-Close Knife and Utensil Organizer in Maple/Stainless

Features two universal knife inserts, stainless steel utensil bin, and adjustable shelf for lower storage.

- 25 1/2" H
- R.448KB.BCSC.11C 11" w x 21 5/8" D \$554.99
- R.448KB.BCSC.8C 8" w x 21 5/8" D \$483.67

Base Cabinet Bottom and Side Mount Soft-Close Organizer Pullout



- (2) Adjustable shelves with chrome accents
- Blumotion soft-close full extension drawer slides
- Natural maple construction
- Mounts to cabinet door, floor and side

If you're tired of cluttered, unorganized and hard to access cabinets, then look no further than Rev-A-Shelf's bottom and side mount pullout shelving system. 21 3/4" Deep

- Face Frame; 25 9/16" Height
- R.449.BCSC.5C 6 1/4" - 6 3/4" Width \$317.99
 - R.449.BCSC.8C 9 1/4" - 9 3/4" Width \$363.62
- Frameless; 25 3/16" Height
- R.449.BCSC.7C 7 1/2" Width \$309.99
 - R.449.BCSC.10C 10 1/2" Width \$373.99



Utensil Bin Base Organizer in Maple/Stainless

Stop digging through drawers for utensils and say goodbye to unsightly, space monopolizing counter bins with the 448UT pullout designed specifically for storing a multitude of utensils.

- 25 1/2" H
- R.448UT.BCSC.8C 8" W x 21 5/8" D \$377.99
- R.448UT.BCSC.5C 5 1/2" W x 21 5/8" D \$333.99



Application



Spice Racks for 448.BC Series

Simply drop into desired shelf and organize spices! Also works for countertops! 21" D x 4 7/8" H

- R.448.SR8.1 8" W \$49.87
- R.448.SR11.1 11" W \$63.23



Soft-Close Pullout Base Organizer W/ BLUMotion

These soft-close base organizers glide effortlessly on Blumotion soft-close slides and the concealed slide design is the utmost in cleanliness.

21 5/8" D x 25 1/2" - 29 1/2" H

- | SKU | Min. Cab. Opening | Each |
|----------------|-------------------|----------|
| R.448.BCSC.5C | 6" Wide | \$274.99 |
| R.448.BCSC.6C | 7 1/2" Wide | \$291.99 |
| R.448.BCSC.8C | 9" Wide | \$304.99 |
| R.448.BCSC.9C | 10 1/2" Wide | \$343.99 |
| R.448.BCSC.11C | 12" Wide | \$357.99 |
| R.448.BCSC.14C | 15" Wide | \$432.80 |



Base Organizer w/Upper Slide

Designed for full-height 6" and 9" base cabinets (respectively). 23" D x 27 5/16" H

- R.438.BC.3C 3" W \$163.05
- R.438.BC.6C 6" W \$233.23



Soft-Close Base Cabinet Pullout Tray Divider

Designed for 9" and 12" base cabinets, this maple pullout tray divider features two compartments for storing baking sheets and platters and removable center racks.

- 19 1/2" H
- R.447.BCBBSC.5C 5 1/4" W x 21 5/8" D \$240.99
- R.447.BCBBSC.8C 8" W x 21 5/8" D \$267.99
- R.447.BCSC.5C 5 7/16" W x 21 1/2" D \$268.99
- R.447.BCSC.8C 8" W x 21 9/16" D \$307.99



Woven Basket with Rails Kits

- Includes basket, canvas liner & rails
- 21.25" Depth x 7.38" Height
- Designed for 15" or 18" base cabinet

Woven Basket Kit for 15" Base Cabinet

- R.4WV.15MP Maple 14.5" Width \$137.62
- R.4WV.15WN Walnut 14.5" Width \$218.14

Woven Basket Kit for 18" Base Cabinet

- R.4WV.18MP Maple 17.5" Width \$144.94
- R.4WV.18WN Walnut 17.5" Width \$232.23



Undersink Pullout w/ Soft-Close, U-Shaped Basket

- 29 1/2" - 31 3/4" W x 22" D x 5 1/4" H
- R.5786.30CR Chrome \$283.38

- 32 1/2" - 34 3/4" W x 22" D x 5 1/4" H
- R.5786.33CR Chrome \$297.19

- 29 1/2" - 31 3/4" W x 22" D x 5 1/4" H
- R.5386.30BCSC.MP Maple \$364.72

- 32 1/2" - 34 3/4" W x 22" D x 5 1/4" H
- R.5386.33BCSC.MP Maple \$374.24



Door Right/Blind Left Applications



3-Shelf Wire Pull-Slide-Pull Blind Corner, Soft-Close

This non-handed PSP3 Series maximizes space in blind corner cabinets.

20 1/4" D
26 1/4" W have 15" Min. Opening Width
32 1/4" W have 18" Min. Opening Width

Chrome Bottom, 24" H

- R.5PSP3.15SC.CR 26 1/4" W \$657.61
- R.5PSP3.18SC.CR 32 1/4" W \$724.22

Maple Bottom, 21" H

- R.53PSP3.15SC.MP 26 1/4" W \$876.20
- R.53PSP3.18SC.MP 32 1/4" W \$930.92



Chrome, Two-Tier Cookware Organizer

Adjustable dividers accommodate different sizes of cookware.

- 22" D x 18 1/8" H
- R.5CW2.1222.CR 11 3/4" W \$119.99
- R.5CW2.2122.CR 20 3/4" W \$189.99



Chrome, Blind Corner Optimizer, Non-Handed

Functional, reliable and stylish. 20 1/4" D x 21" H

- 26 1/4" Wide, 15" Min. Opening Width
- R.5PSP.15SC.CR Soft-Close \$469.99
- R.5PSP.15.CR-12 Not Soft-Close \$489.99

- 32 1/4" Wide, 18" Min. Opening Width
- R.5PSP.18SC.CR Soft-Close \$509.99
- R.5PSP.18.CR-12 Not Soft-Close \$511.99

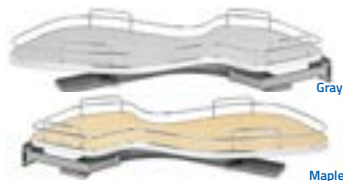

The Cloud Single-Tier Blind Corner Pullout Organizer

For left door/blind-right or right door/blind-left cabinets, the Cloud floats on a bottom-mount, smooth glide track.

For 15" Openings; 33" W x 21 7/8" D x 6 1/2" H

R.5371.15.GR.L	Left Door	Gray	\$206.15	DS
R.5371.15.GR.R	Right Door	Gray	\$205.69	DS
R.5371.15.MP.L	Left Door	Maple	\$209.72	DS
R.5371.15.MP.R	Right Door	Maple	\$209.72	DS

For 18" Openings; 37 5/8" W x 21 9/16" D x 6 1/2" H

R.5371.18.GR.L	Left Door	Gray	\$211.37	DS
R.5371.18.GR.R	Right Door	Gray	\$211.37	DS
R.5371.18.MP.L	Left Door	Maple	\$215.30	DS
R.5371.18.MP.R	Right Door	Maple	\$215.76	DS

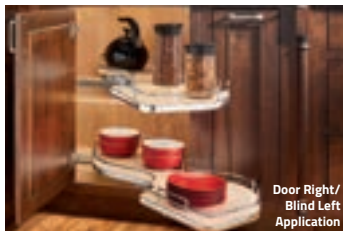

The Cloud Two-Tier Blind Corner Pullout Organizer

For left door/blind-right or right door/blind-left cabinets, the Cloud floats on a bottom-mount, smooth glide track.

For 15" Openings; 33" W x 21 7/8" D x 24 1/2" H

R.5372.15.GR.L	Left Door	Gray	\$603.42	DS
R.5372.15.GR.R	Right Door	Gray	\$603.42	DS
R.5372.15.MP.L	Left Door	Maple	\$534.82	DS
R.5372.15.MP.R	Right Door	Maple	\$534.82	DS

For 18" Openings; 37 5/8" W x 21 9/16" D x 24 1/2" H

R.5372.18.GR.L	Left Door	Gray	\$537.93	DS
R.5372.18.GR.R	Right Door	Gray	\$537.93	DS
R.5372.18.MP.L	Left Door	Maple	\$546.07	DS
R.5372.18.MP.R	Right Door	Maple	\$547.08	DS



Double Chrome Wire Basket

This double chrome wire basket drawer is great for organizing your pots and pans and has full extension slides for easy access.

18"D x 19"H

R.5WB2.0918.CR.1	8 3/4"W	\$112.00
R.5WB2.1218.CR.1	11 3/4"W	\$124.81

22"D x 19"H

R.5WB2.1222.CR.1	11 3/4"W	\$141.92
R.5WB2.1522.CR.1	14 3/4"W	\$150.33
R.5WB2.1822.CR.1	17 3/4"W	\$164.97
R.5WB2.2122.CR.1	20 3/4"W	\$176.41



Combination Knife Holder/Cutting Board Drawer with Blum Soft-Close Drawer Slides

This easy-to-install drawer system features maple construction and TANDEM slides with BLUMOTION soft-close while including a built-in knife organizer, up to four storage compartments, a wood cutting board, and door mounting brackets.

R.4KCB.18SC.1	14 15/16" Width	\$205.33
R.4KCB.24SC.1	20 15/16" Width	\$268.73

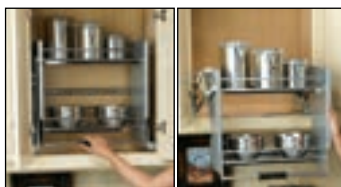

Chrome Wire Pull-Down Shelf for Wall Cabinet

Weight Capacity: 10 lbs. per shelf
10" D x 18 3/8" H

R.5PD.24CRN	24" W	\$560.20
R.5PD.36CRN	36" W	\$589.32



Single Chrome Wire Basket

This single chrome wire basket features full-extension ball-bearing slides, heavy-duty chrome plated frames, and is easy to install (only four screws).

18"D x 7"H

R.5WB1.0918.CR.1	8 3/8"W	\$54.63
R.5WB1.1218.CR.1	11 3/8"W	\$62.22

22"D x 7"H

R.5WB1.1222.CR.1	11 3/8"W	\$71.74
R.5WB1.1522.CR.1	14 3/8"W	\$78.87
R.5WB1.1822.CR.1	17 3/8"W	\$86.47
R.5WB1.2122.CR.1	20 3/8"W	\$92.87

Food Storage Container Organizer

This organizer is the perfect way to keep your food storage containers under control! Features Blumotion soft-close slides and is designed for 18 in. base cabinets.

21 9/16" D x 18 7/8" H

R.4FSCO.18SC.1	14 1/2" W	\$356.21
R.4FSCO.24SC.1	20 1/2" W	\$390.98



Pullout Pilasters



Pilaster Upright Kit for Adjustable Pull-Out Shelves

Includes: (4) Pilasters, & Mounting Hardware (Slides and box not included)
1" W x 1" D x 21" H

R.4PIL.21.10	Brown	\$59.48
R.4PIL.21.SV.10	Silver	\$59.38

Specialty Storage

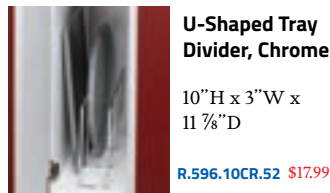

U-Shaped Tray Divider, Chrome

10"H x 3"W x 11 7/8"D

R.596.10CR.52 \$17.99



Heavy-Duty Mixer Lift

- It needs to be installed in a full height base cabinet.
- 60 Lb. weight capacity.
- Can be used with many different widths with a minimum base cabinet frame opening of 12 1/2".
- 20 1/2" Swing radius

R.RAS.ML.HDCR Without Shelf \$139.99



Heavy-Duty Appliance Lift Soft-Close Mechanism, Chrome

Heavy-duty chrome mixer lift with the addition of soft-close. The dampeners allow it to glide back into the cabinet gently and quietly. Needs full height cabinet. Has 60-lb weight capacity and 20 1/2" swing radius.

R.RAS.ML.HDSC	Without Shelf	\$229.99
R.ML.MPHDSCCR.18	With Shelf	\$336.99



Tray Divider

- Comes with (1) divider and (4) screw-in clips
- For base cabinet use
- 20" Depth

R.597.18CR.10	Chrome	18" H	\$10.43
R.597.18.10	White	18" H	\$8.42
R.597.12.10	White	12" H	\$6.77
R.597.12CR.10	Chrome	12" H	\$9.06



Stemware Organizer

4 1/4" W x 1 1/2" H

11" Depth

R.3150.11BR	Brass	\$10.99	DS
R.3150.11CR	Chrome	\$10.99	
R.3150.115N	Satin Nickel	\$10.99	
R.3150.110RB	Oil Rubbed Bronze	\$10.99	

16" Depth

R.3150.16BR	Brass	\$11.53	DS
R.3150.16CR	Chrome	\$10.07	
R.3150.165N	Satin Nickel	\$11.53	DS
R.3150.160RB	Oil Rubbed Bronze	\$13.18	

18" Depth

R.3150.18BR	Brass	\$12.90	DS
R.3150.18CR	Chrome	\$11.25	
R.3150.185N	Satin Nickel	\$12.90	
R.3150.180RB	Oil Rubbed Bronze	\$14.55	



Wine Bottle Under-Cabinet Organizer

4 1/2" W x 9" D

R.3250BR	Brass	\$17.75	DS
R.3250CR	Chrome	\$15.19	
R.32505N	Satin Nickel	\$16.99	DS
R.3250ORB	Oil Rubbed Bronze	\$20.22	

Double-Tiered Trimmable Knife Block Insert

For drawers from 12 1/2" to 18 1/2" wide. 22" Depth

Shown in Walnut

R.4WDKB.1	Maple	2 5/16" H	\$107.42	
R.4WDKB.WN.1	Walnut	2" H	\$305.06	DS



Trimable Wood Spice Tray Insert

With a tiered configuration for total organization and easy access, the maple hardwood spice drawer inserts are coated with a UV-Cured clear finish that ensures a suitable match to any cabinet.

R.4SDI.18	16" W x 19 3/4" D x 1 1/2" H	\$65.99
R.4SDI.24	22" W x 19 3/4" D x 1 1/2" H	\$80.99



Trimable Maple Knife Block with Divider

Rev-A-Shelf's unique Knife Block Tray Insert is out of the box ready at 18 1/2" x 22" providing 19 slots to store knives and has a separate compartment for other utensils. It can be trimmed to fit drawers of various widths and lengths.

R.4WKB.1	18 1/2" W x 22" D x 2 3/8" H	\$86.01
-----------------	------------------------------	----------------



Trimable Cutlery Tray Insert

The WCT Series is made in maple or walnut hardwood with a UV-cured clear finish to ensure an acceptable match to any kitchen cabinet. Dimensions: 22" D

R.4WCT.1	Maple	14 5/8" W x 2 7/8" H	\$66.99
R.4WCT.15H	Maple	14 5/8" W x 2 3/8" H	\$515.99
R.4WCT.WN.15H	Walnut	15 1/8" W x 2 3/8" H	\$113.00 DS
R.4WCT.35H	Maple	20 5/8" W x 2 3/8" H	\$72.99
R.4WCT.WN.35H	Walnut	21 1/8" W x 2 3/8" H	\$152.81 DS

Shown in Walnut



Trimable Wood Utility Tray Insert

This modern day clutter solution requires a simple drop-in installation with two sizes that may be trimmed to fit various drawer sizes. Dimensions: 22" D

R.4WUT.15H	Maple	18 1/2" W x 2 3/8" H	\$62.13
R.4WUT.WN.15H	Walnut	15 1/8" W x 2 3/8" H	\$106.69 DS
R.4WUT.35H	Maple	24" W x 2 3/8" H	\$75.76
R.4WUT.WN.35H	Walnut	21 1/8" W x 2 3/8" H	\$144.57 DS
R.4WUT.1	Maple	18 1/2" W x 2 7/8" H	\$64.78
R.4WUT.3	Maple	24" W x 2 7/8" H	\$82.53

Shown in Maple



Double Tiered Cutlery Tray with Blum Soft-Close Undermount Slides

The WCT Series is made of our classic maple hardwood with a UV-cured clear finish to ensure an acceptable match to any kitchen cabinet.

R.4WTC.15H.1	11 1/2" W x 21" D x 3 3/4" H	\$126.45
R.4WTC.15HSC.1	12" W x 21 1/2" D x 4 5/16" H	\$172.66
R.4WTC.18H.1	14 1/2" W x 21" D x 3 3/4" H	\$151.62
R.4WTC.18HSC.1	14 1/2" W x 21 1/2" D x 4 5/16" H	\$184.10
R.4WTC.21H.1	17 1/2" W x 21" D x 3 3/4" H	\$166.99
R.4WTC.24H.1	20 1/2" W x 21" D x 3 3/4" H	\$149.60

Drawer Front Not Included



Drawer Peg System

Available in three standard sizes, each size can be trimmed to fit and with the easy drop-in installation. Dimensions: 21 1/4" D x 5/8" H (Cut to Fit)

R.4DPS.2421	24 1/4" W (With 9 Pegs)	\$89.67
R.4DPS.3021	30 1/4" W (With 12 Pegs)	\$108.06
R.4DPS.3921	39 1/4" W (With 16 Pegs)	\$140.09
R.4DPSPEG.4	Additional Pegs	\$5.83



Door Storage Tray, Maple

The door storage trays are easy to install with screw-in clips (included) or mount the trays to 26" or 58" standards with standard clips (sold separately).

R.4231.11.52	10 3/4" W x 4 1/4" D x 3 5/8" H	\$39.80
R.4231.14.52	13 3/4" W x 4 1/4" D x 3 5/8" H	\$41.18
R.4231.20.52	19 3/4" W x 4 1/4" D x 3 5/8" H	\$42.91



Door-Mount Spice Rack, Maple

Contains (1) Door Spice Rack, (4) Screws, AMB Brackets. Height Between Shelves is 8 5/8" 3 1/16" D x 21 1/4" H

R.4SR.15	10 1/2" W	\$59.57
R.4SR.18	13 1/2" W	\$72.99
R.4SR.21	16 1/2" W	\$78.99



Adjustable Door-Mount Spice Rack

Add space, flexibility and convenience with Rev-A-Shelf's Adjustable Door-Mount Spice Rack. Available for 15" and 18" wall cabinets. 4" D x 25" H

R.4ASR.15	10 1/8" W	\$84.99
R.4ASR.18	13 1/8" W	\$104.99



Door Storage Wire Spice Rack

The Door Mount Spice Rack is made of heavy-gauge white wire and easily installs with just four screws. 2 3/8" to 4 1/8" Deep 21 3/8" High

R.565.8.52	7 7/8" Width	\$33.12
R.565.10.52	10 5/8" Width	\$37.88
R.565.14.52	13 3/8" Width	\$39.35



Maple Door-Mount Foil Rack

Designed for 15", 18" and 21" cabinets, this beautiful wood organizer brings your foil and storage bags within easy reach.

R.4WFR.15.1	10 1/8" W x 4" D x 8" H	\$57.92
R.4WFR.18.1	13 1/8" W x 4" D x 8" H	\$62.49
R.4WFR.21.1	16 1/8" W x 4" D x 8" H	\$66.98



Orion Gray Door-Mount Spice Rack

Designed for 12", 15" and 18" wall cabinets, the door or wall mountable unit features orion gray flat wire construction, patented adjustable door mount brackets and four fixed shelves that are able to hold spice bottles up to 2-1/4" deep!

R.5365.08.FOG	12" Wall Cabinets 7.88" W x 23.38" H	\$96.72 DS
R.5365.10.FOG	15" Wall Cabinets 10.63" W x 23.38" H	\$101.11 DS
R.5365.14.FOG	18" Wall Cabinets 13.63" W x 23.38" H	\$108.79 DS



Sink Base Organizer

Store cleaning supplies in a convenient spot under the sink. Made of maple hardwood with a UV-cured clear finish.

R.4SBSU.15	10 1/2" W x 5" D x 18 1/2" H	\$68.53
R.4SBSU.18	13 1/2" W x 5" D x 18 1/2" H	\$81.62
R.4SBSU.21	16 1/2" W x 5" D x 18 1/2" H	\$101.00

Trimable Undersink Drip Tray

The unique design not only protects the bottom of your cabinet by holding water; the tray actually funnels excessive water to the front of your cabinet and out onto the floor alerting you of the leak.



Sink Base, 23 1/4" D x 3/4" H		
R.SBDT.2730.A.1	Almond	28 1/2" W \$40.99
R.SBDT.2730.S.1	Silver	28 1/2" W \$44.93
R.SBDT.3336.A.1	Almond	34 1/2" W \$45.57
R.SBDT.3336.S.1	Silver	34 1/2" W \$50.14
R.SBDT.3942.A.1	Almond	40 1/2" W \$50.14
R.SBDT.3942.S.1	Silver	40 1/2" W \$55.17
Vanity, 20 1/4" D x 3/4" H		
R.SBVDT.2124.A.1	Almond	22 1/2" W \$36.87
R.SBVDT.2124.S.1	Silver	22 1/2" W \$40.63
R.SBVDT.2730.A.1	Almond	28 1/2" W \$40.99
R.SBVDT.2730.S.1	Silver	28 1/2" W \$45.11 DS
R.SBVDT.3336.A.1	Almond	34 1/2" W \$45.57
R.SBVDT.3336.S.1	Silver	34 1/2" W \$50.14

DS = Drop Ship (ships directly from vendor to customer)



Shown with Standard Pivot Hinges

Plastic Sink Front Tray, White

Dimensions: 2 1/8" D x 3 13/16" H
R.6581.11.11.4-240 11" W \$4.37
R.6581.14.11.4-240 14" W \$2.19



Shown with Standard Pivot Hinges

Plastic Sink Front Tray w/Ring Holder, White Polymer

Dimensions: 2 1/8" D x 3" H
R.6591.11.11.4 11" W \$4.85
R.6591.14.11.4 14" W \$4.85



Plastic Sink Front Tray w/ Wing Stops, White Polymer

Dimensions: 2 1/8" D x 3 13/16" H

R.6561.11.11.4 11" W Tap Stop \$4.58
R.6561.14.11.4-240 14" W Tab Stop \$4.58

Standard Pivot Hinge

Deduct 1" per side when selecting tray
R.LD.0220.45.40 \$5.76 per Pair

Soft-Close Tip-Out Hinge

Requires 2 5/8" Clearance
R.LD.0220.50SC.40 \$18.67 per Pair

Soft-Close Tip-Out Hinge For Full Overlay

Requires 2 5/8" Clearance
R.LD.0220.50SCFO.40 \$20.48 per Pair

Lazy Susans

Not-So-Lazy Susan for Corner Cabinets

Rev-A-Shelf offers organizing solutions that fit your lifestyle. Clean, simple and easy to access organizers that transform your spaces into works of art in just minutes.

- Maple Finish, Engineered Wood
- (7) Adjustable Hooks
- 28 3/8" - 29 1/4" Adjustable Height
- Lower Tray Additional Storage
- Mid-Level Adjustable Arrestor Secures Cookware
- Quick Fit Self-Adjusting Hardware for Easy Installation & Maintenance-Free Operation
- Cooking Accessories Not Included



R.NSL5-KM-325-7 32" Diameter \$287.49



Maple Rim Lazy Susan Shelf, Full Round

Hardware sold separately. 1 drilled tray and one undrilled tray included.

R.LD.4NW.001.28HBM.1 28" D \$108.30
R.LD.4NW.001.32HBM.1 32" D \$133.26 **DS**



Maple Rim Lazy Susan Shelves, Kidney

Hardware sold separately. One drilled tray and one undrilled tray included.

R.LD.4NW.401.28HBM.1 28" D \$184.36
R.LD.4NW.401.32HBM.1 32" D \$306.52

One Shelf



Maple Rim Lazy Susan, Kidney

Features a kidney shape design, an aluminum bearing, and a solid maple steam-bent rim.

R.LD.4NW.401.28BS.1 28" D \$165.52
R.LD.4NW.401.32BS.1 32" D \$193.07



Maple Rim Lazy Susan, Round

Features an aluminum bearing, and a solid maple steam-bent rim.

R.LD.4NW.001.18B.1 18" D \$95.71
R.LD.4NW.001.24B.1 24" D \$137.16
R.LD.4NW.001.28B.1 28" D \$153.72
R.LD.4NW.001.32B.1 32" D \$180.62

Two Shelf



Two Shelf Maple Rim Lazy Susan, Kidney

This lazy susan features two kidney shape shelves, an aluminum bearing, and a solid maple steam-bent rim.

- Independently-rotating shelves
- 26" - 31" Telescoping post

R.LD.4NW.472.28.1 28" D \$279.99
R.LD.4NW.472.32.1 32" D \$319.99



Two Shelf Maple Rim Lazy Susan, Round

This lazy susan features two round shelves, an aluminum bearing, and a solid maple steam-bent rim.

- Independently-rotating shelves
- 26" - 31" Telescoping post

R.LD.4NW.072.18.1 18" D \$166.16
R.LD.4NW.072.24.1 24" D \$226.28
R.LD.4NW.072.28.1 28" D \$272.67
R.LD.4NW.072.32.1 32" D \$307.62
R.4WLS072.28.52 28" D \$283.10
R.4WLS072.32.52 32" D \$293.07



Classic Wood Kidney-Shape Lazy Susan

Classic kidney shelves and a 1" diameter, chrome-plated, telescoping shaft.

- Independently-rotating shelves
- 26" - 32" Telescoping post

R.4WLS472.24.52 24" D \$293.07
R.4WLS472.28.52 28" D \$255.65
R.4WLS472.32.52 32" D \$327.48

Classic Wood Full Round Lazy Susan

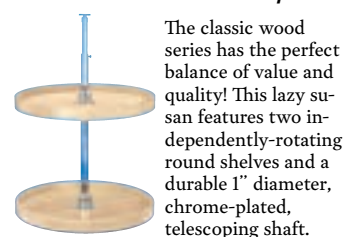

The classic wood series has the perfect balance of value and quality! This lazy susan features two independently-rotating round shelves and a durable 1" diameter, chrome-plated, telescoping shaft.

- Independently-rotating shelves
- 26" - 32" Telescoping post

R.4WLS072.18.52 18" D \$179.71
R.4WLS072.20.52 20" D \$202.40
R.4WLS072.28.52 28" D \$283.10
R.4WLS072.32.52 32" D \$293.07



Banded Wood Full Round

This economical lazy susan features two round shelves, a laminated hardwood rim, and a telescoping shaft.

- Independently-rotating shelves
- 26" - 32" Telescoping post

R.LD.4BW.062.18.1 18" D \$145.12
R.LD.4BW.062.20.1 20" D \$146.03
R.LD.4BW.062.24.1 24" D \$174.31
R.LD.4BW.062.28.1 28" D \$201.30
R.LD.4BW.062.32.1 32" D \$238.63



Banded Wood Kidney

This economical lazy susan features two kidney shelves, a laminated hardwood rim, and a telescoping shaft.

- Independently-rotating shelves
- 26" - 32" Telescoping post

R.LD.4BW.472.24.1 24" D \$160.99
R.LD.4BW.472.28.1-12 28" D \$179.99
R.LD.4BW.472.32.1-12 32" D \$212.99



Two Shelf Lazy Susan, Round

This two-shelf lazy susan features two shelves, and a 3/4" diameter telescoping zinc shaft.

- Independently-rotating shelves
- 24" - 31" Telescoping post

R.6012.18.11.52 18" D \$59.99
R.6012.20.11.52 20" D \$66.99
R.6012.24.11.52 24" D \$73.99
R.6012.28.11.52 28" D \$88.99



Two Shelf Full Round Lazy Susan

A two shelf set, featuring our 1" chrome plated shaft with height adjustment.

- Independently-rotating shelves
- 26" - 32" Telescoping post

R.6072.16.11.52 16" D \$101.38
R.6072.18.11.52 18" D \$107.99
R.6072.20.11.52 20" D \$122.99
R.6072.24.11.52 24" D \$142.99
R.6072.28.11.52 28" D \$151.99
R.6072.32.11.52 32" D \$159.99



Two Shelf Lazy Susan, Kidney

The 6472 Series is a two shelf set, featuring our 1" chrome plated shaft system with a height adjustment.

- Independently-rotating shelves
- 26" - 32" Telescoping post

R.6472.18.11.52	18" D	\$92.99
R.6472.24.11.52	24" D	\$100.99
R.6472.28.11.52-36	28" D	\$115.50
R.6472.32.11.52-22	32" D	\$135.99



Two Shelf Door Mount Lazy Susan, Pie-cut

This kitchen cabinet lazy Susan has pie cut shelves made from polymer and features a snap pin design.

- Independently-rotating shelves
- 26" - 31" Telescoping post

R.LD.2942.18.11.1	White	18" D	\$68.35
R.LD.2942.18.15.1	Almond	18" D	\$68.35 ^{DS}
R.LD.2942.24.11.1	White	24" D	\$73.11
R.LD.2942.24.15.1	Almond	24" D	\$73.11
R.LD.2942.28.11.1	White	28" D	\$89.76
R.LD.2942.28.15.1	Almond	28" D	\$89.76



Two Shelf Lazy Susan, Kidney

Dependently rotating two-shelf design and molded Polymer hubs, a Twist-N-Lock shaft, and independently rotating shelves.

R.LD.2472.24.11.1	24" D	\$61.99
R.LD.2472.28.11.1-18	28" D	\$69.99
R.LD.2472.32.11.1-11*	32" D	\$85.99

*Made of Polystyrene



Two Shelf Polypropylene Lazy Susan, Round

This independently rotating 2 shelf set features molded Polymer hubs and a Twist-N-Lock shaft with a unique patented snap pin design.

R.LD.2062.18.11.1-24	18" D	\$44.40
R.LD.2062.24.11.1-20	24" D	\$44.19
R.LD.2062.28.11.1-18	28" D	\$68.80
R.LD.2062.32.11.1-11*	32" D	\$70.65

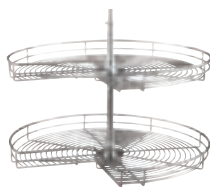

Chrome Wire Lazy Susan

Heavy-duty chrome wire, and has a Post Height of 26" - 32".

R.5472.28CR	28" D	\$288.77
R.5472.32CR	32" D	\$320.34

Kidney Lazy Susan, Shelf Only



Single shelf for use with post: R.BM1.18.52 or R.BM1.04.52. Shelf only—no hardware included.

R.6471.28.11.52	28" D	\$44.65
R.6471.32.11.52-22	32" D	\$51.61



Three Shelf Polypropylene Lazy Susan, Round

This independently rotating 3 shelf set features molded Polymer hubs and a Twist-N-Lock shaft.

R.LD.2063.1836.11.1	18" D	\$71.83
---------------------	-------	---------



Three Shelf Lazy Susan, Round

This three-shelf lazy susan features three shelves, and a 3/4" diameter telescoping zinc shaft.

- Independently-rotating shelves
- 38" - 46" Telescoping post

R.6013.18.11.526	18" D	\$88.30
R.6013.20.11.526	20" D	\$97.81

33" Half Moon White Polymer



The Half Moon Series includes standard and 90 degree hinge euro brackets and chrome-plated shaft and mounting brackets to help distribute the weight from the cabinet wall to the floor of the cabinet.

1 1/2" Minimum Opening		
R.6881.33.11.52	Single Shelf Set	\$127.55
R.6882.33.11.570	Two Shelf Set	\$212.19

Compost Container Pullouts

Rev-A-Shelf offers a complete line of waste containers that feature a self-contained odor-reducing bin.

Single, Bottom-Mount Compost Recycling Container, 12"W x 16"D x 18.75"H



- Includes: (12) compostable liners and (2) carbon filters
- Mounts to cabinet floor easily with 4 screws
- 16" Deep, full-extension 100 lb. rated slides
- 6-Gallon compost bin designed for 30" sink base or 15" base cabinet
- Air vents to speed up compost process

R.RV.1216.CKBK.1	Black	\$198.10 ^{DS}
R.RV.1216.CKGR.1	Green	\$198.10 ^{DS}
R.RV.1216.CKOG.1	Orion Gray	\$198.10 ^{DS}

Maple, Full-Extension, Soft-Close Compost Pullout, 132 Lb. Capacity



- Single Bin: 11.63"W x 18.5"D x 18.56"H
- Compost & 35 Qt.: 15"W x 21.75"D x 20.38"H
- Includes (12) compost liners & (2) carbon filters
- Natural maple dovetail frame
- Single compost bin has rear storage area
- Air vents help speed up the compost process

SKU	Bin Color	Each
6-Gallon Compost Bin (30" Sink or 15" Base Cabinets)		
R.4WCSC.CKBK.1	Black	\$347.97 ^{DS}
R.4WCSC.CKGR.1	Green	\$347.97 ^{DS}
R.4WCSC.CKOG.1	Orion Gray	\$347.97 ^{DS}



SKU	Bin Color	Each
6-Gal Compost Bin & 35 Qt. Container (18" Base Cabinets)		
R.4WCSC.1835CKBK.2	Black	\$404.70 ^{DS}
R.4WCSC.1835CKGR.2	Green	\$404.70 ^{DS}
R.4WCSC.1835CKOG.2	Orion Gray	\$404.70 ^{DS}

Aluminum, Full-Extension, Soft-Close Compost Pullout, 85 Lb. Capacity



- Single Bin: 10.81"W x 18"D x 18.06"H
- Compost & 35 Qt.: 14.81"Wx22.13"Dx19.06"H
- Includes (12) compost liners & (2) carbon filters
- Single Compost Bin has a rear storage area
- Odor-reducing mechanism
- Air vents help speed up compost process

SKU	Bin Color	Each
6-Gallon Compost Bin (30" Sink or 15" Base Cabinets)		
R.5349.15CKBK.1	Black	\$347.12 ^{DS}
R.5349.15CKGR.1	Green	\$342.12 ^{DS}
R.5349.15CKOG.1	Orion Gray	\$342.12 ^{DS}
R.5349.15CKWH.1	White	\$342.12 ^{DS}



SKU	Bin Color	Each
6-Gal Compost Bin & 35 Qt. Container (18" Base Cabinets)		
R.5349.18CKBK.2	Black	\$399.76 ^{DS}
R.5349.18CKGR.2	Green	\$399.76 ^{DS}
R.5349.18CKOG.2	Orion Gray	\$399.76 ^{DS}
R.5349.18CKWH.2	White	\$399.76 ^{DS}

Waste Pullouts

Waste Bin Replacements



SKU	Vol	Dimensions (WxDxH)	Color	Each
R.RV.1024W	27 Qt	11" x 10 7/8" x 17 3/4"	White	\$17.75
R.RV.1024.17.52	27 Qt	11" x 10 7/8" x 17 3/4"	Met. Silver	\$32.94
R.RV.35-96	35 Qt	14 3/8" x 10 1/2" x 17 7/8"	White	\$9.38
R.RV.35.17-96	35 Qt	14 3/8" x 10 1/2" x 17 7/8"	Met. Silver	\$15.00
R.RV.50-60	50 Qt	10 3/4" x 14 3/4" x 21 3/4"	White	\$13.11
R.RV.50.17.8	50 Qt	10 3/4" x 14 3/4" x 21 3/4"	Met. Silver	\$22.42

Waste Lid Replacements



SKU	Vol	Dimensions (WxDxH)	Color	Each
R.RV.35.LID.1	35 Qt	10 3/16" x 14 1/8" x 7/8"	White	\$14.27
R.RV.35.LID.G.1	35 Qt	10 3/16" x 14 1/8" x 7/8"	Green	\$16.10
R.RV.35.LID.17.1	35 Qt	10 3/16" x 14 1/8" x 7/8"	Met. Silver	\$16.10
R.RV.50.LID.17.1	50 Qt	10 1 1/16" x 14 3/4" x 7/8"	Met. Silver	\$17.29
R.RV.50.LID.1	50 Qt	10 1 1/16" x 14 3/4" x 7/8"	White	\$15.37



Top Mount Rev-A-Motion™ Wood Pullout, Double Bin

This Soft-Open/Soft-Close Rev-A-Motion™ pullout features front, side and rear adjustable mounting brackets that provide stability and easy installation. These products are constructed of solid maple and available in four sizes, and feature pre-assembled door mount brackets for easy one-step installation.

SKU	Vol.	Dimensions (WxDxH)	Each
R.4WCTM.RM.2135DM.2	35 Qt	18 1/4" x 21 7/8" x 21"	\$304.60

Top Mount Wood Pullout

Front side mounting, rear adjustable mounting brackets, pre-assembled door mounting brackets and ball-bearing, 150 lb.- rated over-travel slides. **Lids sold separately.**



Full Height Base Cabinet Required

SKU	Vol.	Dimensions (WxDxH)	Each
Single Bin			
R.4WCTM.12BBSCDM1	35 Qt	12" x 22 3/4" - 24" x 21 3/4"	\$131.21
R.4WCTM.1550BBSCDM.1	50 Qt	18" x 22 3/4" - 24" x 21 3/4"	\$137.43
Double Bin			
R.4WCTM.18DM2-25	35 Qt	16 1/2" x 22 3/4" x 17 7/8"	\$137.21
R.4WCTM.18BBSCDM2	35 Qt	15" x 22 1/2" - 24" x 17 7/8"	\$156.65
R.4WCTM.18DM2.175	35 Qt	14 1/2" x 22 3/4"-24 1/2" x 17 7/8"	\$141.37
R.4WCTM.21DM2.162	35 Qt	17 3/4" x 22 3/4" x 17 7/8"	\$147.22
R.4WCTM.2150BBSCDM.2	50 Qt	18" x 22 3/4" -24" x 21 3/4"	\$168.45

Bottom Mount



RV Series, Single Bin

The RV Series features a heavy-duty wire frame construction; 3/4 or full-extension ball-bearing slides and easy bottom mount installation with just four screws. **Lids sold separately.**

SKU	Vol.	Dimensions (WxDxH)	Color	Each
R.RV.12PBS-24	35 Qt	10 5/8" x 22" x 19"	White	\$83.99
R.RV.12KD.17CS	35 Qt	10 5/8" x 22" x 19 1/4"	Silver	\$75.84

RV Series, Double Bin



This double bin version features a heavy-duty wire frame construction; 3/4 or full-extension ball bearing slides and easy bottom mount installation with just four screws.

SKU	Vol.	Dimensions (WxDxH)	Color	Each
R.RV.15KD.17CS	27 Qt	11 13/16" x 22 1/4" x 19 1/4"	Silver	\$95.86
R.RV.18KD.17CS	27 Qt	14 3/8" x 22" x 19 1/4"	Silver	\$93.99
R.RV.15PB.25	27 Qt	11 13/16" x 22 1/4" x 19 1/8"	White	\$117.99
R.RV.18KD.18CS	35 Qt	14 3/8" x 22" x 19 1/4"	Black	\$107.42
R.RV.18PB.25	35 Qt	14 3/8" x 22" x 19 1/4"	White	\$130.99

Optional Door Mount Kit for RV Series



R.RVDMKIT	White	\$28.99
R.RVDM17KIT	Metallic Silver	\$28.99

This heavy-duty door mounting kit is compatible with the RV series and comes in white or silver-colored metal.



Trash Pullout with Soft-Close Slides, Metallic Silver Bins

These single and double bin models are the natural maple wood bottom mount waste container kit. They come with Blumotion tandem slides. **Lids sold separately.** Compatible with Blum Servo Drive.

SKU	Vol.	Dimensions (WxDxH)	Each
Single			
R.4WCSC.1535DM19.1	35 Qt	12" x 18 5/8" x 19 1/2"	\$267.99
R.4WCSC.1535DM.1-12	35 Qt	12" x 21 3/4" x 19 1/2"	\$326.99
R.4WCSC.1550DM.1	50 Qt	12" x 21 3/4" x 23 3/8"	\$329.99
Double			
R.4WCSC.1835DM.2-16	35 Qt	15" x 21 3/4" x 19 1/2"	\$357.99
R.4WCSC.2135DM.2	35 Qt	18 1/2" x 21 3/4" x 19 1/4"	\$363.99
R.4WCSC.2150DM.2-12	50 Qt	18" x 21 3/4" x 23 3/8"	\$389.99

Soft-Close Pullout Waste Container System



This brushed aluminum system with Rev-A-Motion™ Soft-Open/Soft-Close slide technology provides smooth operation even under the heaviest of loads and has an adjustable (10" High) door mount frame.

SKU	Vol.	Dimensions (WxDxH)	Color	Each
Single Bin				
R.5349.15DM.117	35 Qt	10 3/4" x 21 15/16" x 19 1/4"	Silver	\$324.99
R.5149.15DM.111	35 Qt	12 1/8" x 22" x 19 1/2"	White	\$283.74 ^{DS}
R.5149.15DM.117	35 Qt	12 1/8" x 22" x 19 1/2"	Silver	\$293.99
Double Bin				
R.5349.1527DM.2	27 Qt	11 11/16" x 22 1/4" x 18 15/16"	White	\$293.99
R.5349.1527DM.217	27 Qt	11 11/16" x 22 1/4" x 18 15/16"	Silver	\$339.99
R.5349.18DM.217	35 Qt	14-13/16" x 22 1/8" x 19 1/4"	Silver	\$355.99
R.5149.18DM.211	35 Qt	14 3/16" x 22" x 19 1/2"	White	\$293.99
R.5149.18DM.217	35 Qt	14 3/16" x 22" x 19 1/2"	Silver	\$293.99
R.5349.18DM.2	35 Qt	14 13/16" x 22 7/8" x 19 1/4"	White	\$313.99



Bottom Mount Rev-A-Motion™ Wood Pullout

The only bottom mount units available with Rev-A-Shelf's soft-open/soft-close slide system. This innovative gas spring assisted system allows the unit to open smoothly and shut softly, even under the heaviest of loads. **Lids sold separately.**

SKU	Vol.	Dimensions (WxDxH)	Color	Each
Single Bin				
R.4WCBM.15DM.1	35 Qt	12" x 21 3/4" x 19 1/4"	Silver	\$312.11
R.4WCBM.1550DM.1	50 Qt	12" x 21 3/4" x 23 3/16"	Silver	\$314.12
Double Bin				
R.4WCBM.2430DM.2*	30 Qt	20 1/4" x 21 3/4" x 19 1/4"	Silver	\$386.40
R.4WCBM.18DM.2-16	35 Qt	14 1/4" x 21 3/4" x 19 1/4"	Silver	\$277.95
R.4WCBM.2150DM.2-12	50 Qt	17 1/4" x 21 3/4" x 23 3/16"	Silver	\$328.32

*Lids are not available for this product



Undermount Soft-Close Waste Container

Adding trash storage that compliments your kitchen is easy with this line of beautiful wire-framed waste containers. Available in an array of sizes, it comes in two colors, slides effortlessly on progressive roller undermount slides and is easy to install. Assembly of frame is required (**Double Container shown in picture**).

SKU	Vol.	Dimensions (WxDxH)	Color	Each
Single				
R.53WC.1535SCDM.112	35 Qt	10 7/8" x 22 1/4" x 19"	Champagne	\$202.99 ^{DS}
R.53WC.1535SCDM.117	35 Qt	10 7/8" x 22 1/4" x 19"	Metallic Silver	\$195.99
R.53WC.1550SCDM.112	50 Qt	10 7/8" x 22 1/4" x 22 7/8"	Champagne	\$203.99 ^{DS}
R.53WC.1550SCDM.117	50 Qt	10 7/8" x 22 1/4" x 22 7/8"	Metallic Silver	\$195.99
Double				
R.53WC.1527SCDM.217	27 Qt	11 1/4" x 22 1/8" x 19"	Metallic Silver	\$203.99
R.53WC.1835SCDM.212	35 Qt	14 3/8" x 22 1/4" x 19"	Champagne	\$209.99
R.53WC.1835SCDM.217-20	35 Qt	14 3/8" x 22 1/4" x 19"	Metallic Silver	\$203.99
R.53WC.2150SCDM.212	50 Qt	14 3/4" x 22 1/4" x 22 7/8"	Champagne	\$216.99
R.53WC.2150SCDM.217-20	50 Qt	14 3/4" x 22 1/4" x 22 7/8"	Metallic Silver	\$206.99



Fillers & Pullouts



Blind Corner Pullout, Frosted Nickel

Units designed for left and right blind corners. For 15" minimum opening.

26 3/16" W x 22 3/16" D x 19 3/4" H
KV.BCUSLR15CH Right Corner **\$865.08**

26 3/16" W x 22 3/16" D x 26 3/4" H
KV.BBCTL15 Left Corner **\$896.54**

KV.BBCTR15 Right Corner **\$896.54**



Wicker Basket Organizer Components, 21.25" Length

- For installation, calculate frame width less 6mm (1/4") for ease of use runners
- Baskets are sold individually

Basket with Handle for 15" W Cabinets
HA.540.55.001 7.88"Wx11.31"W **\$150.32**

Basket with Handle for 18" W Cabinets
HA.540.55.002 7.88"Wx14.31"W **\$155.36**

Runner For Framed Cabinets
HA.540.55.991 1 3/8" W x 1" T **\$35.89**

Runner for Frameless Cabinets
HA.540.55.992 1 5/8"Wx1 1/4" T **\$37.30**



Single-Tiered Trimmable Tableware Tray

Get rid of clutter and increase space in your kitchen drawers with this tableware tray.

Dimensions: 2 3/16" H x 17 5/16" - 21" D

KV.TW850W 8 3/4" - 11 3/4" W **\$14.74**

KV.TW1217W 12 3/8" - 14 11/16" W **\$16.43**

KV.TW1517W 15 5/8" - 17 11/16" W **\$24.02**

Specialty Storage



Tray Divider Roll-Out, White

KV.TDRO6W 6" W **\$76.66**

KV.TDRO9W 9" W **\$92.39**

This roll-out tray divider comes in white and is a simple, convenient way to access your kitchen supplies! Heavy-gauge steel wire partitions section off storage areas. 19 1/2" Height x 22" Deep



Maple Platform for Appliance Lift

KV.WAL1351 13 1/2" W x 18" D **\$97.96**

KV.WAL1651 16 1/2" W x 18" D **\$114.66**

Maximum load capacity should not exceed 30 lbs.

Tray Divider Roll-Out, Wood & Wire



KV.TDROFNW6 5 15/16" W **\$178.34**

KV.TDROFNW9 8 11/16" W **\$210.98**

The roll-out tray divider slides out on heavy-duty, full-extension ball-bearing slides. 14" Height x 22 1/4" Deep



Euro - Tray Hinge

Deduct 2" per side when selecting tray

KV.ETHW Pair **\$7.97**



Stainless Steel Sink Front Tray

Dimensions: 2" D x 3" H

KV.SF11 11 3/16" W **\$13.80**

KV.SF14 14" W **\$14.50**

KV.SF19 19 1/16" W **\$16.20**

KV.SF25 25 1/16" W **\$19.04**

KV.SF31 31 1/16" W **\$20.64**



Plastic Sink Front Tray

Dimensions: 1 5/8" D x 3" H

KV.PSF11PFW 11" W **\$7.68**

KV.PSF14PFW 14" W **\$8.50**

Dimensions: 2" D x 3" H

KV.PSF2425W 24 3/8" W **\$9.74**

KV.PSF3025W 30 7/16" W **\$10.62**

Lazy Susans



Spice Susan

This Spice lazy susan has a 10" diameter and a plywood core. It comes in a maple wood. Great for easy spice access in the kitchen. Includes swivel. 10" Diameter x 1 1/2" Height (1" Lip)

67.T7210MNL1 **\$26.21**



Kidney Round Lazy Susan

Features independent-ly rotating shelves, strengthening ribs, and a telescoping post range of 25 1/2" to 31-1/2".



KV.PKN18STW 18" D **\$61.10**

KV.PKN24STW 24" D **\$84.72**

KV.PKN28STW 28" D **\$109.54**

KV.PKN32STW 32" D **\$128.38**

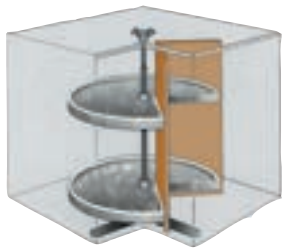

33" Half Moon White Polymer

This plastic door-mount lazy susan unit easily attaches to the door of your corner cabinet and allows both of the shelves to swing out smoothly, making hard to reach items easily accessible.

- KV.PPN24SW 24" D \$95.08
- KV.PPN28SW 28" D \$118.62



Full Round Lazy Susan

This full round lazy susan has a double wall rim, independently rotating shelves, strengthening ribs, and a telescoping post range of 25 1/2" - 31 1/2".

- KV.PFN18STW 18" D \$63.38
- KV.PFN20STW 20" D \$73.82
- KV.PFN24STW 24" D \$86.86
- KV.PFN28STW 28" D \$114.16
- KV.PFN32STW 32" D \$143.16

Parts Included

- A. (2) Shelves
- B. (1) Telescopic Post
- C. (2) Universal Mounting Plates
- D. (2) Bearing Hubs
- E. (2) Bearing Pins
- F. (8) #8 x 1/2" screws
- G. (1) Installation Template

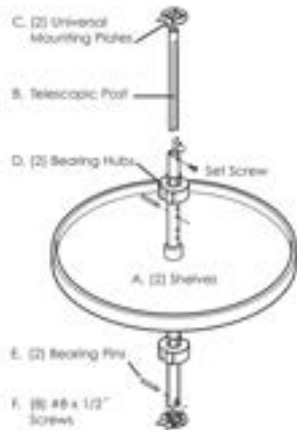

Tools Required

- Phillips head Screwdriver
- Drill with 1/16" (1.5mm) bit for drilling pilot holes
- Tape measure or ruler
- Pencil

Waste Pullouts



SCB Single Bin

Features medium-duty, full extension ball-bearing slides with soft-close technology and 1" over travel. **Lid sold separately.**

SKU	Vol.	Color	Each
9 3/4" W x 20 1/8" D x 18 13/16" H KV.SCB10135PT	35 Qt	Platinum	\$121.66
KV.SCB10135WH	35 Qt	White	\$121.66
11 3/8" W x 20 1/8" D x 22 7/8" H KV.SCB12150PT	50 Qt	Platinum	\$130.70

14 3/8" W x 16" D x 17 5/16" H KV.SCB15120PT	20 Qt	Platinum	\$120.34
KV.SCB15120WH	20 Qt	White	\$120.34

8 3/8" W x 20 1/8" D x 17 5/16" H KV.SCB9120PT	20 Qt	Platinum	\$97.88
KV.SCB9120WH	20 Qt	White	\$97.88

SCB Series, Double/Triple/Quadruple Bin



SKU	Vol.	Color	Each
Double Bin, 14 3/8" W x 22" D x 18 13/16" H KV.SCB15235PT	35 Qt	Platinum	\$163.04
KV.SCB15235WH	35 Qt	White	\$163.04

Lids sold separately

Optional Door Mount Kit for SCB Series



KV.PDMKTPT Frosted Nickel \$20.06



Waste Bin Replacements

SKU	Vol	Dimensions (WxDxH)	Color	Each
KV.QT20PBWH	20 Qt	14 1/4" x 7 1/4" x 16"	White	\$17.46
KV.QT20PBPT	20 Qt	14 1/4" x 7 1/4" x 16"	Platinum	\$16.10 ^{DS}
KV.QT27PBW	27 Qt	10 5/8" x 10 5/8" x 17 3/4"	White	\$26.08
KV.QT35PBWH	35 Qt	14 1/4" x 9 3/16" x 17 1/2"	White	\$19.06
KV.QT35PBPT	35 Qt	14 1/4" x 9 3/16" x 17 1/2"	Platinum	\$19.06
KV.QT50PB-P	50 Qt	15 3/8" x 11 1/8" x 21 5/8"	Platinum	\$28.88
KV.QT50PB-W	50 Qt	15 3/8" x 11 1/8" x 21 5/8"	White	\$28.88

Waste Lids Replacements

SKU	Vol	Dimensions (WxDxH)	Color	Each
KV.QT20LBW	20 Qt	14 1/2" x 7 7/16" x 3/4"	White	\$12.42
KV.QT20LBPT	20 Qt	14 1/2" x 7 7/16" x 3/4"	Platinum	\$12.42 ^{DS}
KV.QT35LBW	35 Qt	14 1/2" x 9 9/16" x 3/4"	White	\$15.84
KV.QT35LBPT	35 Qt	14 1/2" x 9 9/16" x 3/4"	Platinum	\$15.84



USC Series Undermount, Soft-Close, Door Mount, 35 Qt.

Features heavy-duty, undermount slides with soft-close technology. Color coordinated aluminum side rails provide stability and conceal slide hardware for a clean appearance. 14 13/16" W x 22 7/16" D x 19 3/8" H

SKU	Bins	Color	Each
KV.USC12135WH	Single	White	\$245.12
KV.USC12135PT	Single	Platinum	\$245.12
KV.USC15235WH	Double	White	\$259.70
KV.USC15235PT	Double	Platinum	\$259.70

Lids sold separately



TSC Series Top, Soft-Close, Door Mount, 35 Qt.

Features full extension ball-bearing slides with soft-close technology and 1" over travel. 23 3/16" D x 17 1/2" H

SKU	Bins	Width	Color	Each
KV.TSC12135WH	Single	11 1/2"	White	\$203.98
KV.TSC12135PT	Single	11 1/2"	Platinum	\$203.98
KV.TSC15235WH	Double	15"	White	\$224.10
KV.TSC15235PT	Double	15"	Platinum	\$224.10
KV.TSC18235WH	Double	17 1/2"	White	\$246.36
KV.TSC18235PT	Double	17 1/2"	Platinum	\$246.36

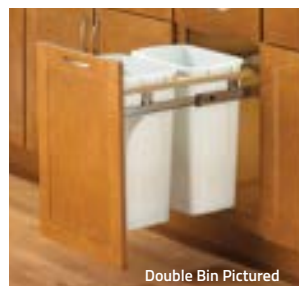

PDMTM Series, Top, Door Mount, 35 Qt.

This unit is door-mounted and features medium-duty, full extension, ball-bearing slides with 1" over travel. Door-mount brackets feature six-way adjustability for precise door alignment and easy installation. 22 1/2" D x 17 1/2" H

SKU	Bins	Width	Color	Each
KV.PDMTM12135WH	Single	12"	White	\$123.60
KV.PDMTM15235WH	Double	15"	White	\$178.86
KV.PDMTM18235WH	Double	18"	White	\$206.16

Filler/Pullouts

Pull-Out Spice Rack, Wooden Cabinet



Pull-Out Spice Rack, Wooden Cabinet Accessory, Width (14 7/8) 365mm, Cabinet Width (18") 457mm Installs in under 5 minutes Unique upper cabinet design keeps supplies close to cooking and prep areas

HA.545.06.101 \$178.20



Wall Pull out

For use as a pull-out in 9" (229mm) framed cabinets Adjustable shelves Without case Type of pull out: Full extension, ball bearing slides Load bearing capacity: 100 lbs (45 kg)

SKU	Dimensions (WxDxH)	Each
Single		
HA.545.47.212	4 7/8" x 26" x 11"	\$178.20
HA.545.47.214	7 7/8" x 26" x 11"	\$210.16

Base Cabinet Filler PullOut With Grass Elite Undermount Slides.



Filler Pull-Out for Base Cabinet with Grass Elite Soft-Close Undermount Slides

Load bearing capacity: 80 lbs

SKU	Dimensions (WxDxH)	Each
Single		
HA.545.47.241	3" x 23 3/4" x 30"	\$290.64
HA.545.47.243	6" x 23 3/4" x 30"	\$352.58

Base Cabinet Pull-Out With Elite Undermount Slides



Can also be used with Frameless cabinets. Installs easily to the floor of the cabinet with provided screws. Grass Elite undermount slides provide a smooth and reliable operation. Top shelf is open for easy access Door mount brackets provide micro adjustment With adjustable guide bushings for stability

Door attachment screws are not provided.

SKU	Dimensions (WxDxH)	Each
Single		
HA.545.47.272	5 1/4" x 22 7/8" x 25 3/8"	\$390.04
HA.545.47.274	7 7/8" x 22 7/8" x 25 3/8"	\$437.42
HA.545.47.275	10 7/8" x 22 7/8" x 25 3/8"	\$479.52



Wall Filler Pull-Out

For use between cabinets as a filler. With 3 shelves With case

SKU	Dimensions (WxDxH)	Each
Single		
HA.545.47.256	3" x 11 1/4" x 30"	\$180.64
HA.545.47.257	3" x 11 1/4" x 36"	\$219.98
HA.545.47.258	3" x 11 1/4" x 42"	\$233.36
HA.545.47.266	6" x 11 1/4" x 30"	\$252.08
HA.545.47.267	6" x 11 1/4" x 36"	\$261.30
HA.545.47.268	6" x 11 1/4" x 42"	\$286.18

Specialty Storage

Double Cutlery, Drawer Insert



Double Cutlery, Drawer Insert for cabinet width: 15" (381 mm)

Comes completely assembled and ready to install Finished solid maple silverware dividers installed on both upper and lower drawer box Prepped for Häfele, Blum or Salice Undermount slides (not include/sold separately)

SKU	Dimensions (WxDxH)	Each
Single		
HA.556.48.800	11 1/2" x 21" x 4 3/16"	\$294.04
HA.556.48.801	14 1/2" x 21" x 3/16"	\$312.84
HA.556.48.802	17 1/2" x 21" x 3/16"	\$332.10
HA.556.48.803	20 1/2" x 21" x 4 3/16"	\$351.36

Wicker Basket, With Frame Handles



Natural Wicker Basket With Lacquered Beech Hardwood Frame

Runners Sold Separately

SKU	Dimensions (WxDxH)	Each
Single		
HA.540.55.001	11-5/16" x 21-1/4" x 7-7/8"	\$150.32
HA.540.55.002	14-5/16" x 21-1/4" x 7-7/8"	\$155.36

SKU	Dimensions	Each
Single		
HA.540.55.991	44 mm	\$35.89
HA.540.55.992	40 mm	\$37.30

None-Slip Mats

Non-Slip Mat, Fiber Black



Cut-to-size non-slip mats prevent sliding or movement of items on shelves, drawers, etc.

Material: Face/Rubber; Back/Polystyrene

HA.547.92.325	1170 x 501 mm	\$26.84
HA.547.92.326	1170 x 600 mm	\$35.06

Non-Slip Mat, Fiber Black Umber Gray



Cut-to-size non-slip mats prevent sliding or movement of items on shelves, drawers, etc.

HA.547.92.525	1170 x 501 mm	\$28.56
HA.547.92.526	1170 x 600 mm	\$35.06
HA.547.92.625	1170 x 501 mm	\$30.78

Cabinet Protector Mat, Polystyrene



Cabinet Protector Mat, Black/Stainless, Polystyrene

Cut-to-size to fit under sink cabinet Unique dimples collect up to 1 gallon water per 6 square feet 23 5/8" x 45 1/4" (600 mm x 1150 mm) Material: Polystyrene

HA.547.91.350 Black/stainless \$91.94

Cabinet Protector Mat, Polystyrene



Cabinet Protector Mat, Gray/Stainless, Polystyrene

Cut-to-size to fit under sink cabinet Unique dimples collect up to 1 gallon water per 6 square feet 23 5/8" x 45 1/4" (600 mm x 1150 mm) Material: Polystyrene

HA.547.91.550 Gray/stainless \$83.48

Non-Slip Mat. Studded

Gray. 600 x 1500 mm (23 5/8" x 59")

HA.547.90.521 \$58.44

Kitchen



24" Kidney Two-Shelf Plastic Lazy Susan Set
 24" Kidney Lazy Susan Set with Twist and Lock Adjustable Pole. Includes 2 Shelves, 1 Mounting Pole, Mounting Hardware and Instructions. Fits interior heights of 21-1/2" to 37-1/4".

SKU	Each
Single	
HR.PLSK224	\$84.89



Kidney Two- Shelf Banded Wood Lazy Susan Set
 Kidney Banded Lazy Susan Set with Twist and Lock Adjustable Pole
 Sold as complete set with shelves, poles, mounting hardware and instructions included

SKU	Diameter	Each
Single		
HR.BLSK228-SET	28"	\$271.84
HR.BLSK232-SET	32"	\$314.91



Pie-Cut Two- Shelf Plastic Lazy Susan Set
 Pie-Cut Plastic Lazy Susan Set : Sold as complete set with shelves, poles, mounting hardware and instructions included
 Fits interior heights of 25-7/8" to 32".

SKU	Diameter	Each
Single		
HR.PLSP24	24"	124.07\$
HR.PLSP28	28"	153.79\$



28" Kidney Banded wood Lazy Susan Shelf with Swivel
 Kidney Banded Lazy Susan with Swivel Pre-Installed Steel Swivel

SKU	Diameter	Each
Single		
HR.BLSK28-S	28"DIA	\$144.67
HR.BLSK32-S	32"DIA	\$166.84



Round Banded Wood Lazy Susan Shelf with Swivel
 Round Banded (Wood) Lazy Susan with Swivel Preinstalled 8" Steel Swivel

SKU	Diameter	Each
Single		
HR.BLSR20-S	20" DIA	\$93.83
HR.BLSR24-S	24" DIA	\$119.83 DS
HR.BLSR28-S	28" DIA	\$134.39



Double Cutlery Drawer
 Double cutlery drawer, Requires Minimum 5" Tall Drawer Opening. Includes Pre-assembled 100 lb Full Extension Inner Drawer Slides. Ships notched and bored, ready for undermount slides which are sold separately. Fits a 24" base cabinet drawer.

SKU	Dimensions (WxDxH)	Each
Single		
HR.CD18	14-1/2" x 21" x 4-3/16"	\$310.06
HR.CD21	17-1/2" x 21" x 4-3/16"	\$340.81
HR.CD24	20-1/2" x 21" x 4-3/16"	\$358.25



3" Base Filler Pullout No wiggle
 3" "No Wiggle" Base Filler Pullout
 Ships as a complete cabinet with a pullout pre-installed and two adjustable shelves included,
 100 lb weight capacity
 Closing Soft-close

SKU	Dimensions (WxDxH)	Each
Single		
HR.BFPO2-3SC	3-1/2" x 23" x 30"	298.28
HR.BFPO2-6SC	6-1/2" x 23" x 30"	409.06



Cabinet Soft-close Pullout, Pre-Assembled "No Wiggle"
 Featuring Premium Soft-close Undermount Slides on the Bottom and Patented Top Mounting Bracket with Heavy Duty Slide on the Top. Ships Fully Assembled with Adjustable Shelves. Requires full door cabinet.

SKU	Dimensions (WxDxH)	Each
Single		
HR.BPO2-5SC	5-1/2" x 22" x 24"	\$266.25
HR.BPO2-8SC	8-1/2" x 22" x 8-1/2"	\$321.04



Pull out with built in tray "No wiggle"
 Removable center rack and adjustable dividing bars allows for easy and versatile customization of storage needs.

SKU	Dimensions (WxDxH)	Each
Single		
HR.BPOTD2-5SC	5" x 22-1/4" x 17-9/16"	\$358.57
HR.BPOTD2-8SC	8" x 22-1/4" x 17-9/16"	\$519.15



Soft-close Appliance Lift
 Appliance Lift with Soft-Close, Features soft-close dampers for smooth closing. Can be used in both frameless and face frame cabinetry
 Minimum cabinet opening 12". Shelf width is determined by measuring between the side mounting brackets minus 1-1/4".

Shelf (not included) can be custom fit to any cabinet size
 HR.ML-1CH H 23-15/16 W 11-1/2" 201.55



12" Base Grooming Organizer Insert for VBPO8-SC
 Converts a "No Wiggle" 8" Vanity Cabinet Pullout (HR.VBPO8-SC) into a grooming organizer with storage for a hair dryer and two other hair appliances. Stainless steel canisters with heatshield ensures no damage to the wood pullout. Insert requires a full door application. #8 flat head screws included

SKU	Dimensions (WxDxH)	Each
Single		
HR.VBPO-G01	8" x 9" x 5"	\$145.76
HR.VBPO-T01	H 3-7/16" W 8-13/32"	\$62.43
HR.VBPO8-SC	8-13/32 x 18-13/16" x 19-7/8"	\$292.11

Filler Waste Pullouts



Double Bottom- Mount Soft Close Waste Pullout

Quart Double Pullout Waste Container System. 1/2 Baltic Birch Plywood Dovetail Construction Mounted on Full Extension Undermount Slides. Patent-pending 6-way Adjustable Door Mounting Brackets. Includes Cans

SKU	Dimensions (WxDxH)	Each
Single		
HR.CDM-WBMD35	14-1/4" x 21-3/8" x 19-1/2"	\$334.46
HR.CDM-WBMD35WH	14-1/4" x 21-3/8" x 19-1/2"	\$334.46
HR.CDM-WBMD50B	15" x 21-3/8" x 23-3/4"	\$377.05
HR.CDM-WBMD50G	15" x 21-3/8" x 23-3/4"	\$377.05
HR.CDM-WBMD50WH	15" x 21-3/8" x 23-3/4"	\$377.05



Single Bottom Mount Soft Close Waste Pull out

Single Pullout Waste Container System. 1/2 Baltic Birch Plywood Dovetail Construction Mounted on Full Extension Undermount Slides. Patent-pending 6-way Adjustable Door Mounting Brackets. Includes Cans

SKU	Dimensions (WxDxH)	Each
Single		
HR.CDM-WBMS35G	11" x 21-3/8" x 19-1/2"	\$308.36
HR.CDM-WBMS35WH	11" x 21-3/8" x 19-1/2"	\$308.36
HR.CDM-WBMS50G	12" x 21-3/8" x 23-3/4"	\$314.06
HR.CDM-WBMS50WH	12" x 21-3/8" x 23-3/4"	\$314.06



Double Waste Rollout for Hinged Doors

Double Pullout Waste Container System. 1/2 Baltic Birch Plywood Dovetail Construction Mounted on Full Extension Undermount Slides. Includes Cans

SKU	Dimensions (WxDxH)	Each
Single		
HR.CAN-WBMD35G	15" x 21-3/8" x 19-1/2"	\$294.74
HR.CAN-WBMD35WH	15" x 21-3/8" x 19-1/2"	\$294.79
HR.CAN-WBMD50G	15" x 21-3/8" x 23-3/4"	\$320.25
HR.CAN-WBMD50WH	15" x 221-3/8" x 23-3/4"	\$320.25



Single Waste Rollout For Hinged Doors

Single Pullout Waste Container System. 1/2 Baltic Birch Plywood Dovetail Construction Mounted on Full Extension Undermount Slides. Includes Can's

SKU	Dimensions (WxDxH)	Each
Single		
HR.CAN-WBMS35G	12" x 21-3/8" x 19-1/2"	\$276.34
HR.CAN-WBMS35WH	12" x 21-3/8" x 19-1/2"	\$276.34
HR.CAN-WBMS50G	12" x 21-3/8" x 23-3/4"	\$290.18
HR.CAN-WBMS50WH	12" x 21-3/8" x 23-3/4"	\$290.18



MEADOW LANE 35 OR 50 QUART DOUBLE WASTE SYSTEM W/GRAY BINS. FOR 15" BASE CABINETS



Meadow Lane Double Waste System (35 or 50 Qt) in Solid Maple, Blum 563 Tandem 100 Lb. Capacity Undermount Silent Slides and Gray Waste Bins Included

- BOM Includes:
- 1 - ML.1400.01.04
 - 1 - ML.1401.01.MA.GY
 - 1 - B.563H5330B
 - 1 - B.T51.1801R
 - 1 - B.T51.1801L

SKU	Dimensions (WxDxH)	Each
35 quart		
ML.1401.01.MA.GY-SB-B	14-5/8" x 21" x 19"	\$305.00
50 quart		
ML.1401.02.MA.GY-SB-B	14-5/8" x 21" x 21"	\$314.00

MEADOW LANE 35 OR 50 QUART DOUBLE WASTE SYSTEM W/WHITE BINS FOR 15" BASE CABINETS



Meadow Lane Double Waste System (35 or 50 Qt) in Solid Maple, Blum 563 Tandem 100 Lb. Capacity Undermount Silent Slides, Slide Brackets and White Waste Bins Included

- BOM Includes:
- 1 - ML.1400.01.04
 - 1 - ML.1401.01.MA.WH
 - 1 - B.563H5330B
 - 1 - B.T51.1801R
 - 1 - B.T51.1801L

SKU	Dimensions (WxDxH)	Each
35 quart		
ML.1401.01.MA.WH-SB-B	14-5/8" x 21" x 19"	\$299.00
50 quart		
ML.1401.02.MA.WH-SB-B	14-5/8" x 21" x 21"	\$306.00



Appliance Garage Kits

- 18 1/2" high x 11 7/8" deep with a 17", 18" or 24" wide face frame
- Kit is complete with tambour door mounted to face frame
- Solid wood face frame
- End panels are veneered face and back on 3/8" MDF
- Spring roll system for assisted opening



SKU	Style	Width	Price
Corner Units, Red Oak			
67.AG-100-C.1V	V-3	17"	\$118.68
67.AG-100-C.1W	SW-30	17"	\$141.19
Corner Units, Cherry			
67.AG-100-C.2V	V-3	17"	\$147.91
67.AG-100-C.2W	SW-30	17"	\$162.47 DS
Corner Units, Hickory			
67.AG-100-C.3V	V-3	17"	\$134.91
67.AG-100-C.3W	SW-30	17"	\$122.06 DS
Corner Units, Maple			
67.AG-100-C.4V	V-3	17"	\$110.66 DS
67.AG-100-C.4W	SW-30	17"	\$152.36
Corner Units, Alder			
67.AG-100-C.6V	V-3	17"	\$126.07 DS
67.AG-100-C.6W	SW-30	17"	\$153.26 DS

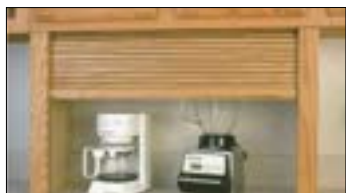

SKU	Style	Width	Price
Straight Units, Red Oak			
67.AG-100-S.1V	V-3	18"	\$124.28
67.AG-100S24.1V	V-3	24"	\$151.31
67.AG-100S24.1W	SW-30	24"	\$147.97 DS
67.AG-100S30.1V	V-3	30"	\$166.61
67.AG-100S30.1W	SW-30	30"	\$168.63 DS
Straight Units, Cherry			
67.AG-100-S.2V	V-3	18"	\$135.12
67.AG-100-S.2W	SW-30	18"	\$166.66
67.AG-100S24.2V	V-3	24"	\$168.38 DS
67.AG-100S24.2W	SW-30	24"	\$159.04 DS
67.AG-100S30.2V	V-3	30"	\$186.06 DS
67.AG-100S30.2W	SW-30	30"	\$197.12 DS
Straight Units, Hickory			
67.AG-100-S.3V	V-3	18"	\$133.12
67.AG-100-S.3W	SW-30	18"	\$105.38 DS
67.AG-100S24.3V	V-3	24"	\$108.64 DS
67.AG-100S24.3W	SW-30	24"	\$129.92 DS
67.AG-100S30.3V	V-3	30"	\$170.02
67.AG-100S30.3W	SW-30	30"	\$237.35 DS

SKU	Style	Width	Price
Straight Units, Maple			
67.AG-100-S.4V	V-3	18"	\$94.08 DS
67.AG-100-S.4W	SW-30	18"	\$109.76 DS
67.AG-100S24.4V	V-3	24"	\$143.99 DS
67.AG-100S24.4W	SW-30	24"	\$168.07 DS
67.AG-100S30.4V	V-3	30"	\$163.59 DS
67.AG-100S30.4W	SW-30	30"	\$175.93 DS
Straight Units, Alder			
67.AG-100-S.6V	V-3	18"	\$140.96 DS
67.AG-100-S.6W	SW-30	18"	\$168.07 DS
67.AG-100S24.6V	V-3	24"	\$133.17 DS
67.AG-100S24.6W	SW-30	24"	\$180.81 DS
67.AG-100S30.6V	V-3	30"	\$165.27 DS
67.AG-100S30.6W	SW-30	30"	\$249.29 DS

Tambour Door Kits for Kitchen Appliance Garages

Kit easily mounts to back of your face frame. Face Frame is not included. The door may be trimmed down if necessary.

Track System Includes:

- (2) PVC Guide Rails
- Donut(s)
- Tension Spring
- Wood Dowel

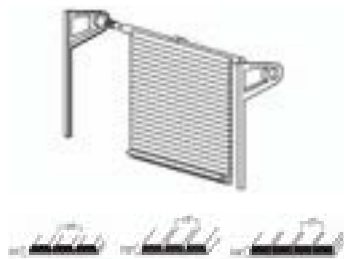

SW-30 Wood Veneer MP-7 Paintable MDF

SKU	Style	Type	Price
15" Slat Length x 18" Height			
67.2A.15.1V	V-3	Red Oak	\$57.25
67.2A.15.1W	SW-30	Red Oak	\$81.85
67.2A.15.2V	V-3	Cherry	\$70.76
67.2A.15.2W	SW-30	Cherry	\$110.57
67.2A.15.3V	V-3	Hickory	\$60.37
67.2A.15.3W	SW-30	Hickory	\$86.00
67.2A.15.4V	V-3	Maple	\$57.21
67.2A.15.4W	SW-30	Maple	\$79.45
24" Slat Length x 18" Height			
67.2A.24.1V	V-3	Red Oak	\$76.74
67.2A.24.1W	SW-30	Red Oak	\$110.57
67.2A.24.2V	V-3	Cherry	\$89.26
67.2A.24.2W	SW-30	Cherry	\$147.04
67.2A.24.3V	V-3	Hickory	\$79.45
67.2A.24.3W	SW-30	Hickory	\$118.62
67.2A.24.4V	V-3	Maple	\$76.27
67.2A.24.4W	SW-30	Maple	\$115.74
30" Slat Length x 18" Height			
67.2A.30.1V	V-3	Red Oak	\$82.63
67.2A.30.1W	SW-30	Red Oak	\$123.92
67.2A.30.2V	V-3	Cherry	\$82.48 DS
67.2A.30.2W	SW-30	Cherry	\$171.79
67.2A.30.3V	V-3	Hickory	\$73.56 DS
67.2A.30.3W	SW-30	Hickory	\$136.64
67.2A.30.4V	V-3	Maple	\$87.38
67.2A.30.4W	SW-30	Maple	\$134.74

Tambour

Tambour 36" H x 47 1/2" Slat W

- Preshrunk Cloth Backing
- 1 1/2" W lead strip on each end



SKU	Style	Type	Price
67.4836.1V	Veneer	Red Oak	\$119.38
67.4836.1W	Solid Wood	Red Oak	\$281.25 DS
67.4836.2V	Veneer	Cherry	\$130.97
67.4836.2W	Solid Wood	Cherry	\$250.88 DS
67.4836.3V	Veneer	Hickory	\$130.97 DS
67.4836.3W	Solid Wood	Hickory	\$270.12 DS
67.4836.4V	Veneer	Maple	\$115.36
67.4836.4W	Solid Wood	Maple	\$249.05 DS
67.4836.6W	Solid Wood	Alder	\$235.63 DS

Specialty Storage



Stemware Rack

This solid wood Stemware Rack is designed to display your beautiful and valuable stemware collection.

SKU	Style	Price
12" x 30", 7 Rows		
67.S96200UF1	Red Oak	\$68.30
67.S9620MUF1	Maple	\$78.20
67.S9620CUF1	Cherry	\$103.94
12" x 36", 8 Rows		
67.S96300UF1	Red Oak	\$90.36
67.S9630MUF1	Maple	\$87.67
67.S9630CUF1	Cherry	\$112.85



Deluxe Wine Racks, Pair

Bottle Openings: 3 3/4" x 3 3/4"

SKU	Style	Price
17" x 36"		
67.L33600UF9	Red Oak	\$103.53 DS
67.L3360MUF9	Maple	\$129.52
67.L3360CUF9	Cherry	\$146.65
23" x 42"		
67.L33200UF9	Red Oak	\$148.33 DS
67.L3320MUF9	Maple	\$160.29 DS
67.L3320CUF9	Cherry	\$193.78



Squared Wine Racks, Pair

Bottle Openings: 3 3/4" x 3 3/4"

SKU	Style	Price
17" x 36"		
67.L30600UF9	Red Oak	\$96.86
67.L3060MUF9	Maple	\$94.60
67.L3060CUF9	Cherry	\$123.72
23" x 42"		
67.L30200UF9	Red Oak	\$121.14 DS
67.L3020MUF9	Maple	\$142.98
67.L3020CUF9	Cherry	\$154.40 DS



Picture: CC.WKB55PF

Wave Knife Block Drawer Insert

- 1 8/8" Depth
- 2 1/8" Height
- Solid Maple, Natural Finish
- Combine with Other Drawer Inserts
- American-Made, Bench-Made

SKU	Width	Holds	Each
CC.WKB55PF	5 5/8"	9 Knives	\$140.19
CC.WKB90PF	9"	15 Knives	\$204.57

Cutting Boards & Butcher Blocks

Butcher Block

- Solid Rubberwood
- All Surfaces pre-oiled with food-grade mineral oil



67.BB3014RUF5	14 3/8" W x 21" D x 1 3/8" H	\$52.66
67.BB3017RUF5	17 3/8" W x 21" D x 1 3/8" H	\$64.98
67.BB3020RUF5	20 3/8" W x 21" D x 1 3/8" H	\$67.56

Cutting Boards

Solid rubberwood center, oak and maple ends with routed finger pulls oiled with food-grade mineral oil.

67.BB2012MUF5	12" W x 23 1/2" D	\$37.41
67.BB2014MUF5	14" W x 23 1/2" D	\$44.58
67.BB2016MUF5	16" W x 23 1/2" D	\$47.38
67.BB2018MUF5	18" W x 23 1/2" D	\$56.11
67.BB2020MUF5	20" W x 23 1/2" D	\$59.25
67.BB2022MUF5	22" W x 23 1/2" D	\$59.07
67.BB2024MUF5	24" W x 23 1/2" D	\$62.50



Our process at Century is different. We don't rely on overseas factories to make accessories for us; we make them ourselves in the United States. That allows us to do our own designing, crafting, and finishing in house; which means we control our own quality. You can have confidence that our products deliver what you are looking for! We also don't mass produce. We don't have rows of automated machinery; but we do have dedicated workers with a solid work ethic, making your products by hand at individual work benches and they are finished with a 60-sheen conversion varnish. The results are stunningly crafted pieces that you will love and have in your home for years to come.

Pullouts



Cascade Base Cabinet Pull-Out

- Edge-Banded Baltic Birch Plywood
- Adjustable Center Shelf
- Blum Tandem Slides Included
- High Sheen Conversion Finish
- American Made
- 21" Deep

Pictured: CC.CASB0115PF

SKU	Dimensions	Opening	Price
CC.CASB035PF	3 1/2"W x 26 1/4"H	4" Min.	\$303.16
CC.CASB045PF	4 1/2"W x 26 1/4"H	5" Min.	\$307.16
CC.CASB055PF	5 1/2"W x 26 1/4"H	6" Min.	\$311.75
CC.CASB085PF	8 1/2"W x 26 1/4"H	9" Min.	\$364.16
CC.CASB0115PF	11 1/2"W x 26 1/4"H	12" Min.	\$462.41



Signature Base Cabinet Pull-Out

- Solid Maple
- Adjustable Center Shelf
- Blum Tandem Slides Included
- High Sheen Conversion Finish
- American Made
- 21" Deep

Pictured: CC.SIGB0115PF

SKU	Dimensions	Opening	Price
CC.SIGB035PF	3 1/2"W x 26 1/4"H	4" Min.	\$329.46
CC.SIGB045PF	4 1/2"W x 26 1/4"H	5" Min.	\$340.19
CC.SIGB055PF	5 1/2"W x 26 1/4"H	6" Min.	\$350.64
CC.SIGB085PF	8 1/2"W x 26 1/4"H	9" Min.	\$424.79
CC.SIGB0115PF	11 1/2"W x 26 1/4"H	12" Min.	\$532.55

Waste Pullouts

Made in the USA

Cascade Waste System

Heavy duty Blum 170 lb. MOVENTO undermount slides included with floor mount installation brackets.

- Baltic birch edgebanded plywood
- Premium dovetail construction on box and face frame top
- Beautiful, natural conversion finish
- 21" Deep
- 19" Height

Pictured: CC.CASBM11PF

SKU	Width	Waste Bins	Price
CC.CASBM11PF	11 7/8" W	Single, 34 Qt.	\$371.43
CC.CASBM14PF	14 7/8" W	Double, 34 Qt.	\$377.30
CC.CASBM17PF	17 7/8" W	Double, 35 Qt.	\$383.67



Pullout Pilasters



X-Series Pilaster Kit for Adjustable Roll-Out Shelves

Compatible with most undermount or sidemount drawer slides. A kit for roll-out drawers include: (8) or (20) brackets to attach slides to pilaster; and (4) trimmable, wood, predrilled pilasters. **Drawer Slides/Rollout Shelves are not included.**

For Two Roll-Out Drawers in Base Cabinets

SKU	Dimensions	Brackets Included	Price
CC.XB150N	20 7/8" L x 1 1/4" W Pilasters	8 Brackets Included	\$97.59
CC.XB150W	20 7/8" L x 2 1/2" W Pilasters	8 Brackets Included	\$125.27
CC.XB250N	28" L x 1 1/4" W Pilasters	8 Brackets Included	\$107.67
CC.XB250W	28" L x 2 1/2" W Pilasters	8 Brackets Included	\$132.48

For Five Roll-Out Drawers in Pantry Cabinets

SKU	Dimensions	Brackets Included	Price
CC.XB550N	58 5/8" L x 1 1/4" W Pilasters	20 Brackets Included	\$207.52
CC.XB550W	58 5/8" L x 2 1/2" W Pilasters	20 Brackets Included	\$249.18

Bracket Sets with Fasteners (Pilasters Not Included)

SKU	Description	Brackets Included	Price
CC.XBONLY1	Hardware for 1 Rollout Shelf	4 Brackets Included	\$19.95
CC.XBONLY20	Hardware for 20 Rollout Shelves	80 Brackets Included	\$337.97
CC.XBONLY50	Hardware for 50 Rollout Shelves	200 Brackets Included	\$825.57
CC.XBONLY200	Hardware for 200 Rollout Shelves	800 Brackets Included	\$3,040.87

Signature Waste System

Pictured: CC.SIGBM11PF



Heavy Duty Blum 170 lb. MOVENTO Undermount Slides Included With Floor Mount Installation Brackets

- North American Maple
- Premium Dovetail Construction on Box and Face Frame Top
- Beautiful, Natural Conversion Finish
- 19" Height x 21" Depth

SKU	Width	Waste Bins	Price
CC.SIGBM11PF	11 7/8"W	Single, 34 Qt.	\$447.56
CC.SIGBM14PF	14 7/8"W	Double, 34 Qt.	\$453.76
CC.SIGBM17PF	17 7/8"W	Double, 34 Qt.	\$459.99

SKU	Type	Price
Replacement Bins and Lids		
CC.34QTN-WH	White 34 Qt. Replacement Bin	\$18.98
CC.34BLD-WH	White Lid for 34 Qt. Bin	\$23.39

Wood Range Hoods & Ventilators

- Call for information on other sizes and styles.
- Copper hoods are available.
- Additional shipping charges may apply.
- Wood hoods ship truckline.
- Allow 4 - 6 weeks for hood delivery.
- All hoods shown in wall mount models are also available in island/peninsula models.
- All hoods can be made in custom sizes.
- All wood hoods are CARB compliant & certified.



Arched Corbel Hood

21 1/4" D x 42" H; Trim Adds 2 1/2" to Overall Unit Width

30" Width		
AP.FDWHAC30-C	Cherry	\$1,237.47
AP.FDWHAC30-H	Hickory	\$1,041.44
AP.FDWHAC30-M	Maple	\$1,112.22
AP.FDWHAC30-RO	Red Oak	\$1,048.76
36" Width		
AP.FDWHAC36-C	Cherry	\$1,436.20
AP.FDWHAC36-H	Hickory	\$1,135.60
AP.FDWHAC36-M	Maple	\$1,197.39
AP.FDWHAC36-RO	Red Oak	\$1,135.60
42" Width		
AP.FDWHAC42-C	Cherry	\$1,344.88
AP.FDWHAC42-H	Hickory	\$1,209.85
AP.FDWHAC42-M	Maple	\$1,290.81
AP.FDWHAC42-RO	Red Oak	\$1,224.11
48" Width		
AP.FDWHAC48-C	Cherry	\$1,539.74
AP.FDWHAC48-H	Hickory	\$1,314.29
AP.FDWHAC48-M	Maple	\$1,386.10
AP.FDWHAC48-RO	Red Oak	\$1,314.29



Detachable Front Mantel Hood

25 1/2" D x 42" H

36" Width		
AP.FDWHDMT36C	Cherry	\$2,237.80
AP.FDWHDMT36H	Hickory	\$1,972.27
AP.FDWHDMT36M	Maple	\$2,080.82
AP.FDWHDMT36RO	Red Oak	\$1,937.20
42" Width		
AP.FDWHDMT42C	Cherry	\$2,331.32
AP.FDWHDMT42H	Hickory	\$2,049.09
AP.FDWHDMT42M	Maple	\$2,164.32
AP.FDWHDMT42RO	Red Oak	\$2,012.35
48" Width		
AP.FDWHDMT48C	Cherry	\$2,424.84
AP.FDWHDMT48H	Hickory	\$2,127.58
AP.FDWHDMT48M	Maple	\$2,251.16
AP.FDWHDMT48RO	Red Oak	\$2,094.18
60" Width		
AP.FDWHDMT60C	Cherry	\$2,678.68
AP.FDWHDMT60H	Hickory	\$2,349.69
AP.FDWHDMT60M	Maple	\$2,486.63
AP.FDWHDMT60RO	Red Oak	\$2,312.95



Arched Raised Panel Hood

20 3/4" D x 42" H; Trim Adds 2 1/2" to Overall Unit Width

30" Width		
AP.FDWHAP30-RO	Red Oak	\$1,048.93
AP.FDWHAP30-M	Maple	\$1,112.22
AP.FDWHAP30-H	Hickory	\$1,048.76
AP.FDWHAP30-C	Cherry	\$1,237.47
36" Width		
AP.FDWHAP36-RO	Red Oak	\$1,135.60
AP.FDWHAP36-M	Maple	\$1,197.39
AP.FDWHAP36-H	Hickory	\$1,135.60
AP.FDWHAP36-C	Cherry	\$1,330.99
42" Width		
AP.FDWHAP42-RO	Red Oak	\$1,224.11
AP.FDWHAP42-M	Maple	\$1,290.91
AP.FDWHAP42-H	Hickory	\$1,224.11
AP.FDWHAP42-C	Cherry	\$1,436.20
48" Width		
AP.FDWHAP48-C	Cherry	\$1,539.74
AP.FDWHAP48-H	Hickory	\$1,314.29
AP.FDWHAP48-M	Maple	\$1,386.10
AP.FDWHAP48-RO	Red Oak	\$1,297.59



Double Panel Hood

20 1/2" D x 42" H; Trim Adds 2 1/2" to Overall Unit Width

30" Width		
AP.FDWHRP0230C	Cherry	\$1,872.07
AP.FDWHRP0230H	Hickory	\$1,564.79
AP.FDWHRP0230M	Maple	\$1,670.00
AP.FDWHRP0230RO	Red Oak	\$1,564.79
36" Width		
AP.FDWHRP0236C	Cherry	\$1,963.92
AP.FDWHRP0236H	Hickory	\$1,648.29
AP.FDWHRP0236M	Maple	\$1,751.83
AP.FDWHRP0236RO	Red Oak	\$1,608.21
42" Width		
AP.FDWHRP0242C	Cherry	\$2,105.87
AP.FDWHRP0242H	Hickory	\$1,786.80
AP.FDWHRP0242M	Maple	\$1,883.76
AP.FDWHRP0242RO	Red Oak	\$1,778.55
48" Width		
AP.FDWHRP0248C	Cherry	\$2,066.29
AP.FDWHRP0248H	Hickory	\$1,867.06
AP.FDWHRP0248M	Maple	\$1,975.61
AP.FDWHRP0248RO	Red Oak	\$1,711.98



Upper Raised Panel Hood

20.625" D x 42" H; Trim Adds 2" to Overall Unit Width

30" Width		
AP.FDWHRP0130C	Cherry	\$1,639.94
AP.FDWHRP0130H	Hickory	\$1,297.97
AP.FDWHRP0130M	Maple	\$1,452.90
AP.FDWHRP0130RO	Red Oak	\$1,346.02
36" Width		
AP.FDWHRP0136C	Cherry	\$1,711.75
AP.FDWHRP0136H	Hickory	\$1,461.25
AP.FDWHRP0136M	Maple	\$1,564.79
AP.FDWHRP0136RO	Red Oak	\$1,331.53
42" Width		
AP.FDWHRP0142C	Cherry	\$1,855.37
AP.FDWHRP0142H	Hickory	\$1,435.97
AP.FDWHRP0142M	Maple	\$1,639.94
AP.FDWHRP0142RO	Red Oak	\$1,533.06
48" Width		
AP.FDWHRP0148C	Cherry	\$1,932.19
AP.FDWHRP0148H	Hickory	\$1,648.29
AP.FDWHRP0148M	Maple	\$1,716.76
AP.FDWHRP0148RO	Red Oak	\$1,648.29

Wall Hood Liners

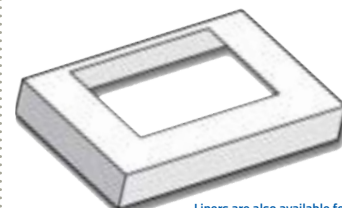

Liners are also available for island/peninsula hoods.

Liners for BUF01A, O11, O2A, O21 Blowers

30" Width, Rectangular		
AP.9106*	BIS, WH, BK, SM	\$140.28
AP.9106SUS	Stainless Steel	\$257.18
36" Width, Rectangular		
AP.9107*	BIS, WH, BK, SM	\$145.29
AP.9107SUS	Stainless Steel	\$290.58

*Choose Finish

BIS	Biscuit	BK	Black
WH	White	SM	Silver Metallic

Liners for BUF06 Blowers

30" Width, Rectangular		
AP.9125SUS	Stainless Steel	\$256.00
36" Width, Rectangular		
AP.9126SUS	Stainless Steel	\$293.92

Liners for BUF08 Blowers

48" Width, Mantel		
AP.9187SUS	Stainless Steel	\$450.00
54" Width, Mantel		
AP.9188SUS	Stainless Steel	\$501.00



Arched Raised Panel Hood



Decorative Curve Hood

20 1/2" D 42" H; Trim Adds 2" to Overall Unit Width

Table with 3 columns: Model, Finish, Price. Rows include 36" Width (Cherry, Hickory, Maple, Red Oak) and 42" Width (Cherry, Hickory, Maple, Red Oak).



Decorative Hood

20.625" D x 42" H; Trim Adds 2" to Overall Unit Width

Table with 3 columns: Model, Finish, Price. Rows include 30" Width, 36" Width, 42" Width, and 48" Width for various finishes.



Valance Hood

7" Depth x 24" Height

Table with 3 columns: Model, Finish, Price. Rows include 30" Width and 36" Width for various finishes.



Classic Valance Hood

7" Depth x 24" Height

Table with 3 columns: Model, Finish, Price. Rows include 30" Width and 36" Width for various finishes.

T-Shaped Valance Hood Liners

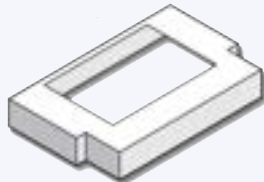

Table with 3 columns: Model, Finish, Price. Rows include 30" Width and 36" Width for various finishes.

***Choose Finish**

Table with 4 columns: Finish Code, Name, Finish Code, Name. Rows include BIS Biscuit, WH White, BK Black, and SM Silver Metallic.

Ventilators

- Extremely Quiet
Easy Clean Finish
Prewired for Electrical Connection
UL/CUL Certified
Backdraft Damper Included
Flush Profile
3-Year Warranty
Ductless Kit available for most blowers



Ventilator, Pro Series 6, Wall & Island Model

8" Round centered duct, 75 sonos/660 cfm, dual 50 watt halogen lights (MR16-GU10 twist base included), wall & island brackets included

Cutout: 25" W x 10 1/2" H x 15 3/4" D
AP.06W/PSUS Stainless Steel \$1,073.81



Ventilator, Extra Quiet Model

7" Round duct, 7.0 sonos/290 cfm, single 50 watt halogen light (MR16-GU10 twist base included)

Cutout: 17 1/4" W x 8 1/4" H x 11 3/8" D

AP.01A* BIS, WH, BK, SM \$347.36
AP.01ASUS Stainless Steel \$390.78



Ventilator, Wall & Island Model*

10" Round centered duct, 8 sonos/980 cfm, dual motors/dual controls with dimmer, dual 50 watt halogen lights (MR16-GU10 twist base included), wall & island brackets included

Cutout: 25" W x 10 3/4" H x 15 3/4" D
AP.07W/PSUS Stainless Steel \$1,466.76

*Must be shipped via truckline.



Ventilator, Extra Quiet Pro Style-Mini

7" Round duct, 7.0 sonos/290 cfm, dual 50 watt halogen lights (MR16-GU10 twist base included)

Cutout: 17 1/4" W x 8 1/4" H x 11 3/8" D

AP.011* BIS, WH, BK, SM \$427.52
AP.011SUS Stainless Steel \$465.93

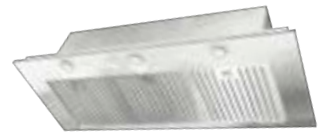

Ventilator, Wall & Island Model*

Two 8" Round ducts, 8.5 sonos/1320 cfm, dual motors/dual controls with dimmer, three 50 watt halogen lights (MR16-GU10 twist base included), wall & island brackets included

Cutout: 43 3/16" W x 9 3/8" H x 16 3/4" D
AP.08W/PSUS Stainless Steel \$1,673.34

*Must be shipped via truckline.



Ventilator, High Performance Model

7" Round duct, 7.0 sonos/390 cfm, single 50 watt halogen light (MR16-GU10 twist base included)

Cutout: 17 1/4" W x 8 1/4" H x 11 3/8" D

AP.02A* BIS, WH, BK, SM \$402.47
AP.02ASUS Stainless Steel \$442.55



Ventilator, Pro Style-Mini

7" Round duct, 7.0 sonos/390 cfm, dual 50 watt halogen lights (MR16-GU10 twist base included)

Cutout: 17 1/4" W x 8 1/4" H x 11 3/8" D

AP.021* BIS, WH, BK, SM \$452.57
AP.021SUS Stainless Steel \$492.65

***Choose Finish**

Table with 4 columns: Finish Code, Name, Finish Code, Name. Rows include BIS Biscuit, WH White, BK Black, and SM Silver Metallic.



Conversion Recirculating Kits

Contains: 2' Section of Pipe, 90 Degree Conversion, Charcoal Filter, & Grill

Compatible With Ventilators:

Small: 01A, 02A, 011, 021, 03A & 04
Large: 06W/P, & 07W/P

Table with 3 columns: Model, Size, Price. Rows include AP.DK-SMALL Small \$131.00 and AP.DK-LARGE Large \$131.00.

Bathroom & Laundry Accessories



L-Shaped Vanity Organizer w/Soft-Close for 24" or 30" Base Cabinets

- Soft-Close, Tandem Blumotion Slides
 - Mounts to Cabinet Floor
 - 18 3/4" D x 18 7/8" H
- R.441.12VSBSC-1 8 3/4" Width \$259.90
R.441.15VSBSC-1 11 1/16" Width \$285.66



Soft-Close Organizer w/Bins for 12" Vanity Base Cabinet

- Includes door mount brackets Small: 8 3/8" W x 19 1/2" D x 20 1/4" H
Large: 8 7/16" W x 19 9/16" D x 25 1/2" H
Maple Finish
- R.448.VC20SC.8 SM 4-Shelf, 6-Bin \$401.59
R.448.VC25SC.8 LG 5-Shelf, 9-Bin \$466.38 ^{DS}

Maple Wood Trash Pullout with Soft-Close Slides, Metallic Silver Bin

- Bottom-Mount
 - Blumotion tandem slides
 - Lid sold separately
 - Compatible with Blum Servo Drive
 - 35 Qt. bin capacity
 - 12"W x 18.63"D 19.5" H
- R.4WCSC.1535DM19.1 \$277.79



Waste & Cleaning Pullout for Under Sink or Vanity, w/Soft-Close Slides

- Includes (1) 8 L. recycle bin w/green lid and (2) 1 L. spray bottles.
(WxDxH): 8 1/16" x 16 1/16" x 14 1/4"
- R.5SBWCC.8S.1 \$99.64



Vanity Appliance Storage Rack

- Two 1.25 qt. stainless steel bins
 - Mounts to cabinet door
 - Designed for 15" base cabinets
 - Natural maple frame
 - 10.69"-14.81" W x 5.94" D x 13.75" H
- R.4HD.15.1 \$78.78

Bottom Mount Pullout Hamper



- Features Rev-A-Motion Slides;
14 1/4" Width
19 3/4" Depth
21" Height

R.4WH.RM.15DM.1 \$326.47



Pictured: R.486.30VSBSC.SM.1

U-Shaped Vanity Pullout with Blum Soft-Close, Maple

- For 30" Vanity Sink Bottom-Mount Includes: (1) 8 qt. bin w/handles, (1) 8 qt. lid, & (4) adjustable dividers
Side-Mount Includes: (2) acrylic bins & (2) adjustable dividers

25.63" W x 18.63" D x 14.19" H
R.486.30VSBSC.BM.1 Bottom-Mount \$262.61
27.5" - 28.75" W x 19 - 20.5" D x 6.44" H
R.486.30VSBSC.SM.1 Side-Mount \$244.85

Bottom Mount Hamper Pullout



- Adjustable door mount brackets
- Soft-Open/Soft-Close technology
- Washable canvas liner
- 19-11/32"H x 14-5/6"W x 18-1/16"D

R.5190.15RM.111 White Wire \$358.68 ^{DS}
R.5190.15RM.117 Gray Wire \$362.34

Pullout Ironing Board

- Expandable frame mounts easily in a vanity drawer between cabinet sides from 14 1/4" to 21" wide. Mounts to standard drawer fronts.

20" OAD, 3.67" H x 18.58" D
R.VIB.20CR \$224.99
R.RAS.VIBCOVER.52 Cover \$13.50
16" OAD, 3.67" H x 15.88" D
R.CIB.16CR \$190.23
R.RAS.CIBCOVER.R.52 Cover \$19.92



Door Storage Organizational Rack for 12", 15" or 24" Base Cabinets

- Includes adjustable mounting brackets to attach to door. Organizer in maple finish.
3 1/8" D x 15 1/2" H

R.4VR.12.1 8 1/4" Width \$68.63
R.4VR.15.1 11 1/4" Width \$75.21
R.4VR.24.1 20 1/4" Width \$79.33



Vanity Grooming Organizer w/Soft-Close for 12" Vanity Base Cabinet

- Includes (2) shelves and (2) stainless steel bins for storing curling irons and hair dryers. Maple Finish.
(WxD): 8 7/16" x 19 9/16"

R.445.VCG20.8 20 1/4" Height \$221.37
R.445.VCG25.8 25 1/2" Height \$280.36



Under-the-Sink Cleaning Caddy, Removable

- 19 1/2" H x 11 1/4" W x 16 1/4" D
- Adjustable Handle that slides either direction to work around plumbing or other obstructions
- Leak-proof trays
- Removable for easy transport

R.544.10C.1 Chrome Wire Finish \$85.19

Trim-to-Fit Vanity Drawer Insert for 22" or Smaller Drawers

- Two clear acrylic lids
- 13 Sections
- Anti-skid lining
- Drop-in installation
- Trim-to-fit
- 2.06" Height

R.4VCOS.22.1 21.75"W x 21.06"D \$107.51 ^{DS}



12.5" H. Door-Mount Scale Holder

- Mounts to cabinet door
- Designed for 15" base cabinets
- Natural maple frame

R.4SH.15.1 10.44"-15"W x 3.56"-4.69"D \$81.89 ^{DS}

Tie Racks & Belt Organizers

Adding a tie rack and belt rack to your closet will help keep your clothing organized while making getting dressed a lot quicker and easier.

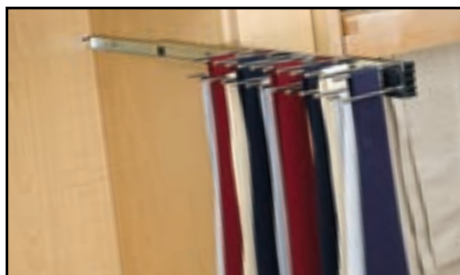

Tie Rack

SKU	Size	Finish	Price
R.TRC.12CR	12"	Chrome	\$21.99
R.TRC.12SN	12"	Satin Nickel	\$16.99 ^{DS}
R.TRC.12ORB	12"	Oil Rubbed Bronze	\$16.99 ^{DS}
R.TRC.14CR	14"	Chrome	\$28.99
R.TRC.14SN	14"	Satin Nickel	\$25.53
R.TRC.14ORB	14"	Oil Rubbed Bronze	\$25.53
R.CRMB.12CR.5	12"	Reverse Mounting Bracket	\$8.50

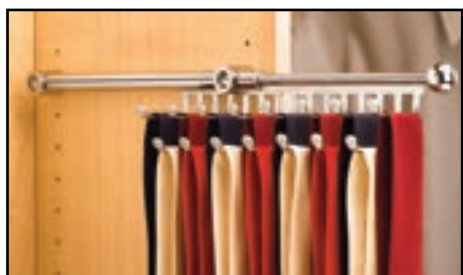

Tie & Scarf Rack

SKU	Size	Finish	Price
R.CTR.12.CR	12"	Chrome	\$54.99
R.CTR.12.ORB	12"	Oil Rubbed Bronze	\$52.89
R.CTR.12.SN	12"	Satin Nickel	\$52.89
R.CTR.14.CR	14"	Chrome	\$46.99
R.CTR.14.ORB	14"	Oil Rubbed Bronze	\$43.99
R.CTR.14.SN	14"	Satin Nickel	\$43.99

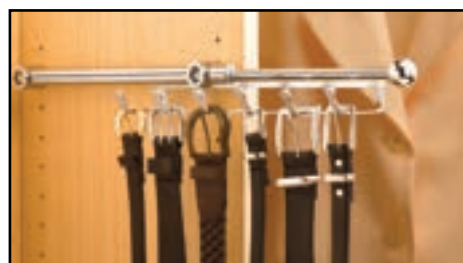

Belt & Scarf Rack



SKU	Size	Finish	Price
R.CBSR.12.CR	12"	Chrome	\$35.99 ^{DS}
R.CBSR.12.ORB	12"	Oil Rubbed Bronze	\$27.99
R.CBSR.12.SN	12"	Satin Nickel	\$27.99
R.CBSR.14.CR	14"	Chrome	\$37.99
R.CBSR.14.ORB	14"	Oil Rubbed Bronze	\$43.46
R.CBSR.14.SN	14"	Satin Nickel	\$43.46



Wood Tie Racks

SKU	Color	Depth	Price
R.CWTR.12.1	Natural	11 7/8"	\$63.70
R.CWTR.14W.1	White	14 3/8"	\$81.44 ^{DS}
R.CWTR.14B.1	Black	14 3/8"	\$81.44
R.CWTR.14.1	Natural	14 3/8"	\$71.92 ^{DS}
R.CWTR.16.1	Natural	15 3/8"	\$83.17
R.CWTR.20.1	Natural	19 3/8"	\$105.41



Belt Rack

SKU	Size	Finish	Price
R.BRC.12CR	12"	Chrome	\$20.99
R.BRC.12SN	12"	Satin Nickel	\$19.86
R.BRC.12ORB	12"	Oil Rubbed Bronze	\$19.86
R.BRC.14CR	14"	Chrome	\$24.99
R.BRC.14SN	14"	Satin Nickel	\$21.50
R.BRC.14ORB	14"	Oil Rubbed Bronze	\$21.50



Wall Mounted, 12" Belt Rack

- Holds 7 Belts
- WxDxH: 1 3/4" x 11 3/4" x 1 3/4"

SKU	Size	Finish	Price
R.BRC.12NS.CR	12"	Chrome	\$14.27
R.BRC.12NS.ORB	12"	Oil Rubbed Bronze	\$12.90
R.BRC.12NS.SN	12"	Satin Nickel	\$12.90

Closet Rods



Pull-Down Closet Rod, Side Mounted

SKU	Adjustable Width	Price
R.CPDR.1826	21.5" - 26"	\$150.99
R.CPDR.2635-24	26" - 35"	\$150.99
R.CPDR.3548	35" - 48"	\$123.99



Maple Glideware Full Extension Soft-Close Valet Hanger, 110 Lb. Capacity



SKU	Dimensions	Price
R.GLD.CV14.1	4" W x 14" D x 5-1/16" H	\$125.63
R.GLD.CV14B.1	6" W x 14" D x 5-1/16" H	\$252.54



Standard Valet Rod



SKU	Size	Description	Price
R.CVL.12.CR	12"	Chrome	\$21.99
R.CVL.12.ORB	12"	Oil Rub Bronze	\$20.99
R.CVL.12.SN	12"	Satin Nickel	\$20.99

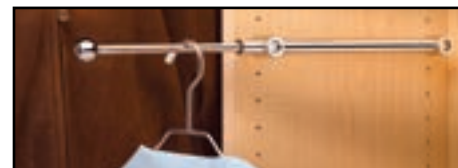

Designer Valet Rod



SKU	Size	Description	Price
R.CVR.12.CR	12"	Chrome	\$23.99
R.CVR.12.ORB	12"	Oil Rub Bronze	\$23.99
R.CVR.12.SN	12"	Satin Nickel	\$23.99
R.CVR.14.CR	14"	Chrome	\$34.99
R.CVR.14.ORB	14"	Oil Rub Bronze	\$32.99

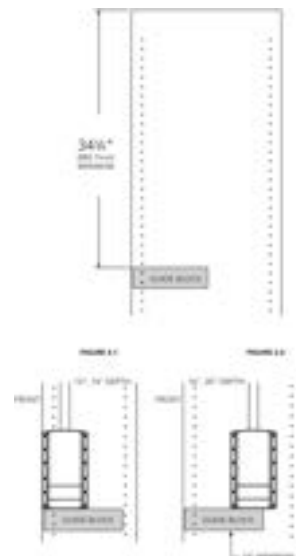

Closet Storage Pullouts



Pullout Closet Mirror, Aluminum Finish

The Rev-A-Shelf Pullout Closet Mirror installs in a space just over 3" wide. This beautiful full length mirror features a soft-open, soft-close slide system, reversible mounting, adjustable 60 degree pivot, and easy installation with only 8 screws.

- 2 5/8" Width
- 13 5/8" Depth
- 48" Height
- 6" Min. Opening



SKU	Finish	Price
R.CMSL.1448.BZ1	Oil Rubbed Bronze	\$369.93
R.CMSL.1448.SM1	Satin Nickel	\$369.75



In Panel Valet Pins



Perfect for hanging one or several items, the CVRI is the ideal addition to any closet; features include the ability to open or close the 3 1/2" rod with a single finger and a removable pull hardware so you can customize the CVRI to match your closets existing hardware.

SKU	Size	Description	Price
R.CVRI.7.CR	7"	Chrome	\$21.99
R.CVRI.7.ORB	7"	Oil Rubbed Bronze	\$20.99
R.CVRI.7.SN	7"	Satin Nickel	\$20.99
R.CVRI.DG	7"	Installation Kit	\$131.39

Only Usable Extended Portion of the Rod is 3 3/4"



Chrome Pull Out Basket



Rev-A-Shelf introduces a breakthrough in design of Closet wire baskets and hamper. Our patent-pending design installs easily in 32 mm applications, and basket removal and re-installation has never been easier.

SKU	Specifications	Price
R.CB.181407CR.1	18" W x 14" D x 7" H	\$64.69
R.CB.181411CR.1	18" W x 14" D x 11" H	\$64.69
R.CB.181418CR.1	18" W x 14" D x 18" H	\$88.85 ^{DS}
R.CB.241407CR.1	24" W x 14" D x 7" H	\$72.74
R.CB.241411CR.1	24" W x 14" D x 11" H	\$81.89
R.CB.241418CR.1	24" W x 14" D x 18" H	\$99.00
R.CB.301407CR.1	30" W x 14" D x 7" H	\$81.25
R.CB.301411CR.1	30" W x 14" D x 11" H	\$91.96
R.CB.301418CR.1	30" W x 14" D x 18" H	\$106.41

Hampers



13-1/2" D x 19-3/4" H Door-Mount, Tilt-Out Hamper Basket

SKU	Finish	Actual Width	Price
R.CTOHB.161319.CR.52	Chrome	15 1/2" W	\$101.11
R.CTOHB.161319.ORB.52	ORB	15 1/2" W	\$95.43
R.CTOHB.161319.SN.52	Sat Nickel	15 1/2" W	\$95.43 ^{DS}
R.CTOHB.211319.CR.52	Chrome	20 1/2" W	\$112.27
R.CTOHB.211319.ORB.52	ORB	20 1/2" W	\$102.48
R.CTOHB.211319.SN.52	Sat Nickel	20 1/2" W	\$102.48

Liners Available

Shoe Storage

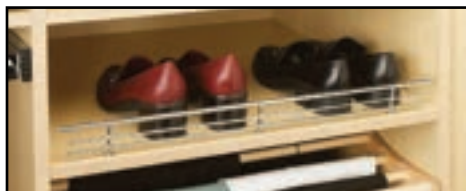

SKU	Size	Finish	Price
R.CSR.17CR.10	17"	Chrome	\$7.69
R.CSR.17ORB.10	17"	Oil Rub. Bronze	\$7.05
R.CSR.17SN.10	17"	Satin Nickel	\$7.05
R.CSR.23CR.10	23"	Chrome	\$9.33
R.CSR.23ORB.10	23"	Oil Rub. Bronze	\$8.51
R.CSR.23SN.10	23"	Satin Nickel	\$8.51
R.CSR.29CR.10	29"	Chrome	\$10.80
R.CSR.29ORB.10	29"	Oil Rub. Bronze	\$9.33
R.CSR.29SN.10	29"	Satin Nickel	\$9.33
R.CSR.35CR.10	35"	Chrome	\$11.80
R.CSR.35ORB.10	35"	Oil Rub. Bronze	\$10.16
R.CSR.35SN.10	35"	Satin Nickel	\$10.16

Pants Rack

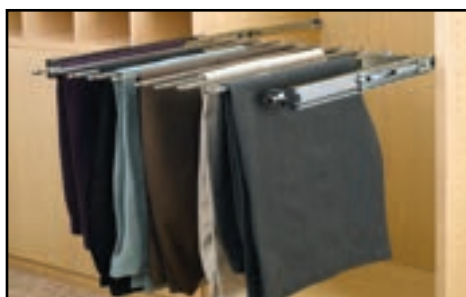

3" H Pants Rack Organizer with Movable Fingers

Contains: (1) Frame Assembly, Chrome Rods, Full-Extension Slides & Instructions

SKU	Closet Size	Specifications	Price
R.PSC.1814CR	18" x 14"	17 1/2" - 18 1/8" W x 14" D	\$109.99
R.PSC.2414CR	24" x 14"	23 3/4" - 24 1/2" W x 14" D	\$133.99
R.PSC.3014CR	30" x 14"	29 3/4" - 30 1/2" W x 14" D	\$150.99

Closet Rods

Need to replace or add a closet rod in your home? Search no further! Custom Service Hardware carries all of the hardware that you need to better your closet application - just choose the finish and style that will look best in your home!

Please note: Closet rods may incur oversized shipping fees. CSH will NOT modify length to avoid shipping charges.

Oval Closet Rod



- Wall Thickness: Steel: 1mm; Aluminum: 1.5mm
- Polished Chrome Plated Steel
- 8' Lengths
- Oval Tube: 15mm x 30mm

SKU	Description	Finish	Price
UF.CR92	Rod (Steel) 92 in.	Chrome	\$14.99
UF.5311146003	Rod (Steel) 8 ft.	Chrome	\$10.99
UF.5331553022	Rod (Aluminum) 8 ft.	ORB	\$23.62
UF.5411146068	Flange with 5mm pins	Chrome	\$0.70
UF.5411153087	Flange with 5mm pins	ORB	\$1.29
UF.5411346013	Flange screw in	Chrome	\$0.71
UF.5411353085	Flange screw in	ORB	\$1.20
EP.831-PC	Oval Rod End Cap	Pol. Chrome	\$1.26
EP.831-ORB	Oval Rod End Cap	ORB	\$1.26
UF.5421546079	Rod Center Support	Chrome	\$1.45
UF.5421553092	Rod Center Support	ORB	\$1.08
UF.7253546185	Shelf & Rod Support	Chrome	\$6.10
UF.7253553190	Shelf & Rod Support	ORB	\$5.99

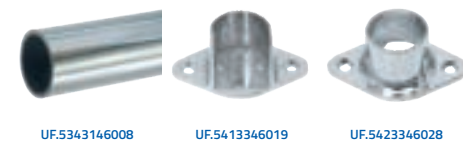

Round Tube, Outside Diameter 1 1/16"

- Outside Diameter of 1 1/16"
- Polished Chrome Plated Steel
- 8' Lengths
- Wall Thickness: 14 Gauge

SKU	Description	Finish	Price
UF.5343146008	Rod 1 1/16" diam. x 8 ft.	Chrome	\$41.94
UF.5413346019	Open Flange for 1 1/16"	Chrome	\$1.99
UF.5423346028	Closed Flange for 1 1/16"	Chrome	\$1.45

Docking Drawer Blade Series

Docking Drawer Blades can be installed in kitchens, bathrooms, closets, and many other places that will provide an innovative and functional power source with a clutter-free appearance.



All screws are included with outlet.



SKU (White) DD.1514-110W Price \$244.00
 SKU (black) DD.1514-110B Price \$244.00

Shallow Drawer Specifications	
Minimum Drawer Box Width	15"
Minimum Interior Drawer Box Height	3" or more
Minimum Space Behind Drawer Box	2" or more
Maximum Base Cabinet Depth	24" or less

Electrical Specifications	
Tamper Resistant	Yes
GFCI	Yes
LED Indicator	Yes
Max Current Ac	15 Amp
Max Current USB-C (single port connected to PD device)	3 amps @ 9 VDC (30W)
Max Current USB- A	3.6 amps@ VDC

BLADE DIMENSIONS

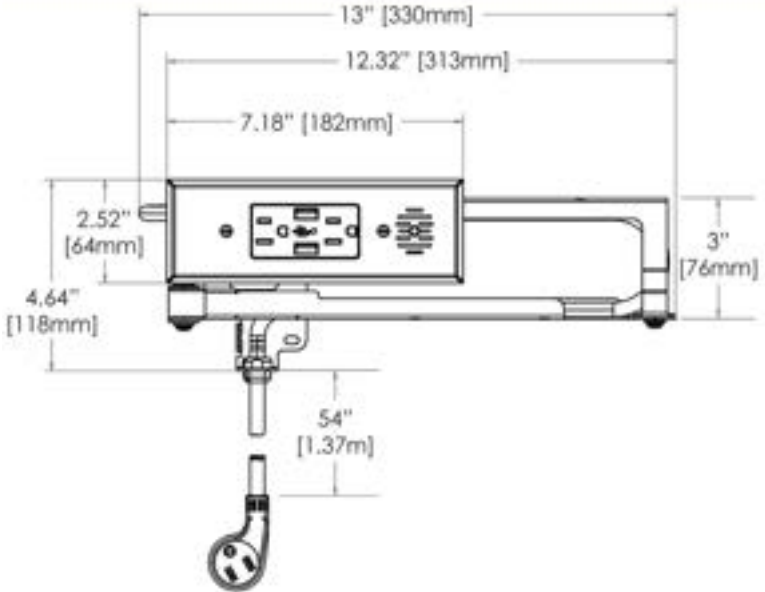

4 DRAWER BOX TYPES

	Minimum Drawer Box Width (G1)	Minimum Interior Drawer Box Height	Minimum Space Behind Drawer Box	Maximum Base Cabinet Depth
Shallow Drawer	15" or more	3" or more	2" or more	24" or less
Tall Drawer	13" or more	4" or more	2" or more	24" or less
Narrow Drawer <small>*Requires a drawer to fit in the cabinet behind the blade for it to work.</small>	9" or more	4" or more	2" or more	24" or less
Vertical Drawer	8" or more	13" or more	2" or more	24" or less

Charging Drawer

Charging Drawer for Frameless (Full Access) Cabinet, Maple



Charge all your electronics together in one complete drawer system with Rev-A-Shelf's 4WCDB Series Charging Drawer. Featuring maple construction with shock adsorbent mat and BLUMOTION soft-close slides, this easy-to-install unit is designed for 18" base cabinets and boasts an integrated cord guide to ensure safe operation and an in-drawer receptacle with two UL safety listed 120V plugs and 2.1 amp USB ports.



SKU	Cabinet Type	Min. Cabinet Opening (WxDxH)	Each
R.4WCDB.18SC.1	Face Frame	15" x 21 1/16" x 4 1/2"	\$375.97
R.4WCDB.18FLSC.1	Frameless	16 1/2" x 21 1/16" x 4 1/2"	\$373.50

Electronic Accessories

USB Chargers & Power Supplies

Power Supply for Dual USB Charger, 2 Amp, 12 Volt



Power Supply for Dual USB Charger; 2 Amp, 12 Volt, Direct Current. To be used with RA.USB2CR.08 or RA.USB2MS.08.

SKU	Each
RA.SPS.2A12VDC2.1-20	\$21.44

Dual USB Charger, Black



Dual USB Charger, Round, Black Uses power supply, RA.SPS.2A12VDC2.1-20 (sold separately).

SKU	Each
RA.USB2CR.08	\$18.24

Power Supply w/Dual 110V USB Outlets, 67" Cord



Cut Out Dimensions: 3-7/8" L x 1-7/8" W (for cut-out clearances) x 2-3/4" D. Need a minimum of 4" deep for clearance of the box and rear exiting power cord). Recommended installation screw: 0.FPC06058B

SKU	Plate Size	Each
RA.PS.2P.2USB.LTUL5" L x 2.25" W		\$22.52

Power Supply for Single USB Charger, 2 Amp, 5 Volt



Power Supply for Single USB Charger; 2 Amp, 5 Volt, Direct Current. To be used with RA.USB.S.01.08 or RA.USBS02.08.

SKU	Each
RA.SPS.2A5VDC	\$9.02

Single USB Charger, Black



Single USB Charger, Screw Mount, Black. Uses power supply, RA.SPS.2A5VDC (sold separately).

SKU	Each
RA.USB.S.01.08	\$6.28

USB Charger Kit w/Charger & Power Supply



Kit Includes:
 (1) RA.USB.S.01.08, Single Power Supply
 (1) RA.SPS.2A5VDC, Single USB Charger
 (2) 0.PPC08012B Screws

SKU	Each
RA.USB.S.01.08KIT	\$16.06

Lighting Accessories



50 Watt MR-16 Light Bulb Quartz Halogen Bi-pin Base

SKU	Description	Each
78.16	Halogen	\$0.94

40 Watt Light Bulb



Bulb 40S11, 120V, Intermediate Base, Clear (to use with Can Light 73.10)

SKU	Description	Each
78.20	Incandescent	\$0.96

20 Watt Xenon Light Bulb



12 Volt (Low Voltage) 82.XC300XW \$6.49

Power Strips

Power Director Harness



One Power Button Feature with Multiple Ports; 15 AMP Circuit Breaker; fits in to 9 3/4" x 1 7/8" cut out. Optional bracket sold separately (76.PDH-2).

SKU	Plate Size	Each
76.PD3000.08	2 1/2" x 10 3/8"	\$54.33

Power Director Harness Hanger



Hanger for Power Director. Mounting Bracket Size: 2" x 4" x 9 7/8"

SKU	Description	Each
76.PDH-2	Harness Hanger	\$4.78

Harness Surface Mount (2 Outlets & 1 USB Port)



Harness Surface Mount with Two Outlets & One USB Port; #14-3 10' Power Cord w/45° Offset Plug, Black

SKU	Face Dimensions	Each
76.FC-737	6 5/8" x 2 3/16"	\$42.44

Harness Surface Mount (4 Outlets & 1 USB Port)



Harness Surface Mount with Four Outlets & One USB Port; #14-3 10' Power Cord w/45° Offset Plug, Black

SKU	Face Dimensions	Each
76.FC-747	11 1/8" x 2 3/16"	\$51.72

Harness Surface Mount (4 Outlets)



Harness Surface Mount with Four Grounded Outlets, 10' Male Cord, Black. *Note: The Power Cord Exits the Side of the Harness.

SKU	Description	Each
76.PH4401.08	Power Strip, Black	\$27.79

Recess Mount Power Supply w/2 Outlets & Child Safety Locks



#14-3 10' Power Cord w/45° Offset Plug, Black
 Cutout: 5 1/4" x 1 7/8"

SKU	Description	Each
76.FC-732	Power Strip, Black	\$28.42

Tresco Lighting



Flexible EquiLine Tape LED 12V

EquiLine Tape LED is the economical alternative to Tresco's Commercial Grade FlexTape. The simple "FlexConnect" connection system makes installation a breeze.

SKU	Color Temp (L)	Each
1.5W, Cuttable Every 2 Inches		
T.L-TPELED-27SER-1	2700 K	240 In. \$202.02
T.L-TPELED-48SER-1	4800 K	240 In. \$150.98
3W, Cuttable Every 1 Inch		
T.L-TPELED-27HER-1	2700 K	196 In. \$159.03
T.L-TPELED-48HER-1	4800 K	196 In. \$159.03

LED Tape Accessories

FlexTape Starter Cord

FlexTape Wattage	Maximum linear run from one starter cord
1.5W	20' (6 m)
3W	16.4' (5 m)



T.L-LED-TPEPKT-2M-1	79" (2m) FlexTape Straight Starter Lead	\$7.14
T.L-TPEPKT-2IN-1	2" (50mm) FlexTape Straight Starter Lead	\$5.31

5/8" (16mm) Hole Required

79" (2m) FlexTape Tee Starter Cord

FlexTape Wattage	Maximum run per side	Maximum run overall
1.5W	20' (6 m)	40' (12m)
3W	16.4' (5 m)	20' (6 m)



T.L-LED-TPEPKT-2M-TEE-1	\$10.16
-------------------------	---------

5/8" (16mm) Hole Required

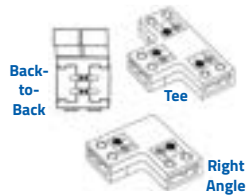

Optional Connectors

SKU	Type	Each
T.L-TPELNK-BTB-1	Back-to-Back, 5/8" x 5/16"	\$1.83
T.L-LED-TPELNK-TEE-1	Tee, 1/4" x 1-1/2" x 1/2"	\$4.21
T.L-LED-TPELNK-CON90-1	Right Angle, 1/4" x 1" x 1/2"	\$3.72

FlexTape Jumper Cord



Positive and negative contacts on FlexTape and FlexConnects should match-up to maintain proper polarity.

T.L-LED-TPELNK-5-1	2" (5cm)	\$3.93
T.L-LED-TPELNK-15-1	6" (15cm)	\$4.21
T.L-LED-TPELNK-25-1	10" (25cm)	\$4.67
T.L-LED-TPELNK-60-1	24" (60cm)	\$5.40
T.L-LED-TPELNK-120-1	48" (120cm)	\$5.58
T.L-LED-TPELNK-180-1	72" (180cm)	\$6.13

12V Universal FREEDiM Receiver



The receiver has a 60W capacity and works with any dimmable 12VDC Tresco lights.

T.L-WLD.1REC-1	\$72.80
----------------	---------

12V FREEDiM Deco Wall Dimmer

This controller has a 65 ft. range from remote to receiver, is a single zone wireless dimmer, controls all Tresco dimmable low voltage lights and requires at least one FREEDiM Universal Receiver for operation.

T.L-WLD-1WAL-WH-1*	\$123.76
--------------------	----------

12V FREEDiM Micro Dimmer

The mounting case comes with an integrated magnet for mounting to metallic surfaces, or can be screw mounted to any wood surface as well. Works with any dimmable 12VDC Tresco lights.

T.L-WLD-1RND-BL-1*	Black	\$29.65
T.L-WLD-1RND-NI-1*	Nickel	\$37.77

*Requires at least one FREEDiM Universal Receiver for Operation

Power Supplies for Flexible Tape and Equiline Puck Lights

SKU	Watt	Description	Price
T.L-DC-ELT15WP-CON-1	15 W	Wall Mount Power Supply w/6 Snap Block	\$28.00
SKU	Watt	Description	Price
T.L-DC-ELT18-CON-1	18 W	12VDC Wall Mount Power Supply w/6 Snap Block	\$53.90

Equiline Puck Lights

Typical Application:

- Furniture
- Desk
- Headboards
- Closet
- Cabinets & Light Boxes



3W Recess, Puck Light, 5000K Cool White Lighting

- 5000K Cool White Lighting
- 100° Beam Spread
- Low Profile
- Dimmable
- 12V Input
- 2 1/2" Outer Diameter
- 2 1/4" Diameter for Recessed Portion
- Use Power Supply: T.L-DC-ELT* (Sold Separately)

SKU	Color	Each
T.L-POC-3EQFR-CNI-1	Nickel	\$24.16
T.L-POC-3EQFR-CBL-1	Black	\$24.16

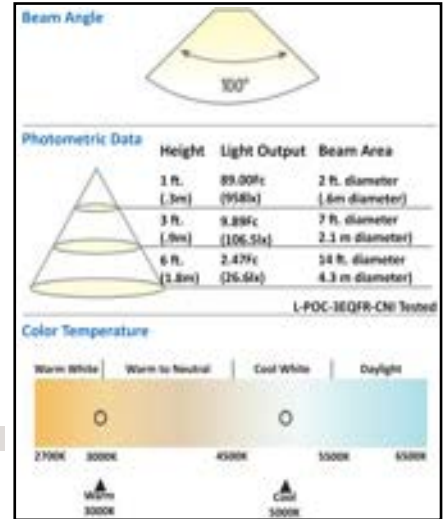

3W Recess, Puck Light, 3000K Warm White Lighting

- 3000K Warm White Lighting
- 100° Beam Spread
- Low Profile
- Dimmable
- 12V Input
- 2 1/2" Outer Diameter
- 2 1/4" Diameter for Recessed Portion
- Use Power Supply: T.L-DC-ELT* (Sold Separately)

SKU	Color	Each
T.L-POC-3EQFR-WNI-1	Nickel	\$24.16

Surface Mount Rings for EquiLine Puck Lights

- Surface Mount Rings Sold Separately
- Available in Black and Nickel Finish

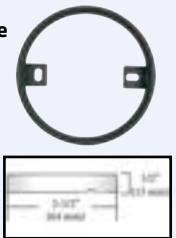

SKU	Color	Each
T.L-SMR-2LED-BL-100	Black	\$3.19
T.L-SMR-2LED-NI-1	Nickel	\$3.93



Cord Set & Dimmer Switches

- Standard Power Cord: 10 Feet
- Standard Female Connector: 2 Feet

Harness 10' Male Cord, 24" Female Cord with Push Switch



Fits 3/4" Panel, Includes: Knurl Nut and Washer
77.09.08 \$18.65

Harness Dimmer 10' Male Cord, Two 72" Female Cords



Full Range Rotary (Knob and screw not included)
77.20-W \$7.42

8 inch Cord Set, T-Blade Female & Male Plug, Black



8" Polarized Male Plug w/Special T-shape Female Plug
77.46 \$2.11

8 ft Cord Set, T-Blade Female & Male Plug, Black



8' Polarized Male Plug w/ Special T-shape Female Plug
77.46.8 \$4.85

Harness Dimmer Knob, Polished Brass



Comes with extension you can use when mounted in 3/4" material (optional).
77.KNOB.06 \$1.84

Harness Dimmer Knob, Black



Comes with extension you can use when mounted in 3/4" material (optional).
77.KNOB.08 \$1.38

Harness Two-Circuit Push Switch, 10' Male Cord, Two 24" Female Cord



Push #1: Light 1 on
Push #2: Light 1 off, Light 2 on
Push #3: Both Lights on
Push #4: Both Lights off
77.31 \$15.49

Harness Normally On, Push Switch, 10' Male Cord, 24" Female Cord



Normally-on switch with Mounting tabs
77.32 \$13.05

Cord Set



Black 3' Female & Male T-Blades Plugs
77.43-3 \$3.99

Harness Dimmer 10' Male Cord, Two 24" Female Cords



Full Range 3-Level Touch Dimmer, 300w Max, Brown
77.21 \$27.52

Touch Dimmer 10' Male Cord, 12" T-Female, 48" Touch Lead



Touch Dimmer, 300 w
77.23 \$26.10

Detachable Plug for SPT-2, Black



UL Listed Detachable plug, Fits the SPT-2 wire
77.500.08 \$0.73

12 Volt Transformers & Dimmer

A 60 Watt Transformer can Power 60 Watts of Lighting. For Example, A 60 Watt Transformer Can Power Three 20 Watt Lights.

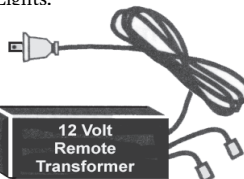

Remote Mount Transformer

Operates Six 10w or Three 20w Lamps; 9 ft. Power Cord

SKU	Wattage	Color	Each
82.060	60 Watt	Black	\$15.08
82.120	120 Watt	Black	\$31.70

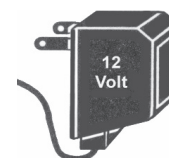

60 Watt Wall Plug Transformer

Wall Plug Dimmable Transformer; 8 ft. Power Cord

SKU	Color	Each
82.TW60CS.08	Black	\$16.94



Amertac Touch Pad Dimmer

SKU	Description	Each
82.6043	Black, w/8 ft. Wire	\$12.36

Incandescent, Intermediate Base



SKU	Watt	Each
78.20	40 Watt	\$0.96

LED Light Bulb, Medium Base

120 Volt, 2700K, Lumen Output Similar for 40 Watt Incandescent, 3 Watts, Can Be Dimmed.



SKU	Watt	Each
76.FC-908	3 Watts	\$26.33



Flex Light

SKU	LEDS	Each
FC.FLEXLIGHT	120	\$84.70

Flex Light

Multiple attachment options

Works great for automotive work

Easy to use in any situation

The Flex Light is the most versatile lighting system you will ever own! It clamps, hangs, and magnetically sticks anywhere. The rechargeable and cordless technology allows you to work on any project that requires lighting with no struggle. The rechargeable battery lasts 7 to 8 hours or can be plugged in for endless illumination.

Features...

- Rechargeable LED light
- 2 brightness options
- 4 mounting options
- Lasts 7 to 8 hours

Great for...

- Illuminating Work Spaces
- Saw Hoods
- Doorways

Description	Part Number	Price
Flex Light	FLEX LIGHT	SEE OUR WEBSITE

Under Cabinet Lighting

120V LED Lighting (No Transformer Needed)



Plastic Strip Lighting

Power Cord Needed But Sold Separately: [AA.L-5600-W](#)

Optional On/Off Switch: [AA.L-555-W](#)

Optional Dimmer: [77.21](#)

Mounting Hardware Included

SKU	Size	Description	Dimensions	Price
Warm White, 3K				
AA.L-1123-W	12"	108 Lumens at 2.8w, 120v	12" x 4 ⁵ / ₆₄ " x 1 ³ / ₃₂ " 2"	\$23.46
AA.L-1163-W	16"	148 Lumens at 2.88w, 120v	16" x 4 ⁵ / ₆₄ " x 1 ³ / ₃₂ " 2"	\$29.40
Cool White, 6K				
AA.L-1126-W	12"	108 Lumens at 2.8 Watts	12" x 4 ⁵ / ₆₄ " x 1 ³ / ₃₂ "	\$23.45
AA.L-1166-W	16"	148 Lumens at 2.88w, 120v	16" x 4 ⁵ / ₆₄ " x 1 ³ / ₃₂ " 2"	\$29.39



LED Under Cabinet Light

White Plastic Light with Two Rows of Warm White (w/2-Way Switch)

Power Cord Needed But Sold Separately: [AA.L-5600-W](#)

Optional Dimmer: [77.21](#)

Mounting Hardware Included

SKU	Size	Description	Dimensions	Price
AA.L-2164-W	16"	336 Lumens at 4w, 120v	16 1 ¹ / ₆ " x 2 1 ¹ / ₄ " x 1 1 ¹ / ₄ "	\$38.13

LED Puck Lights (Linkable, Dimmable)



Surface Mount Ring Diameter: 2 3/4" (1 1/32" Depth)

Recessed Mount Hole Diameter: 2 3/8" (1" Depth) 2"

Male and female lead

Mounting Hardware Included

Power Cord ([AA.L-5600-W](#)) Needed; Sold Separately

Optional On/Off Switch: [AA.L-555-W](#)

SKU	Finish	Light Option	Description	Price
Plastic Puck Lights				
AA.L-3703-W	White	Warm White, 3K	10 LEDs, 80 Lumens at 2.5w	\$17.99
AA.L-3703-SN	Satin Nickel	Warm White, 3K	10 LEDs, 80 Lumens at 2.5w	\$19.98
AA.L-3703-BL	Black	Warm White, 3K	10 LEDs, 80 Lumens at 2.5w	\$17.99
AA.L-3706-BL	Black	Cool White, 6K	10 LEDs, 80 Lumens at 2.5w	\$18.35
Steel Puck Lights				
AA.L-4703-SN	Satin Nickel	Warm White, 3K	10 LEDs, 80 Lumens at 1.8w	\$18.16
AA.L-4706-SN	Satin Nickel	Cool White, 6K	10 LEDs, 80 Lumens at 1.8w	\$18.16

120V LED Lighting Accessories



Butt Connector, White

SKU	Description	Price
AA.L-500-W	For AA.L-2164-W	\$0.96



Connector, On/Off Switch with 4" Male and Female Cord

SKU	Description	Price
AA.L-555-W	On/Off Switch	\$4.26



Connector, White

SKU	Description	Price
AA.L-512-W	12" Connector	\$1.55
AA.L-536-W	36" Connector	\$3.42



Power Cord, White

SKU	Description	Price
AA.L-5600-W	6' without Switch	\$8.16
AA.L-5601-W	6' with Switch	\$9.99

Cordless LED Lighting



SKU	Price
72.L-BTL45W-WWH-10	\$8.05

4 LED Bar Light, Warm White

- with swivel and touch dimmer button
- Requires 3 AAA batteries (not included)
- Warm White Lite
- Peel & Stick mounting

Curio Cabinet Lighting

All lights meet new C.U.L. standards.

All lights include lamps and 10' power cords

The bulbs that come with your lights are Complimentary and are not under warranty. We are not responsible for breakage during shipping or defects.



SKU	Finish	Price per Each		Brown Curio Light Assembly With 8 FT. COrd
		Price	50-Ct	
LE.F101-02	Brown	\$10.84	\$9.29	8" x 2 1/4"



SKU	Finish	Price	Detachable Plug
77.500.08	Black	\$0.73	SPT, 2 Wire

Halogen Puck Lighting



120V Light w/ Female & Male Cords*

Two Leads: (1) 30" T-Female & (1) 30" T-Male; 1 1/2" Deep x 3 1/4" Diameter; 25 Watt
Recommended Screw: [0.PPC08012](#)

SKU	Finish	Price
840.30.08	Black	\$19.72
840.30.06	Brass	\$16.19

*77.23 or 77.46 must be ordered to use these Lights (Sold Separately)



120V Light w/ Male Cords*

One Lead: (1) 30" T-Male; 1 1/2" Deep x 3 1/4" Diameter; 25 Watt
Recommended Screw: [0.PPC08012](#)

SKU	Finish	Price
840.31.08	Black	\$19.37
840.31.06	Brass	\$14.33

*77.23 or 77.46 must be ordered to use these Lights (Sold Separately)

Connecting Multiple Lights in Series



Mount Options for Puck Lights

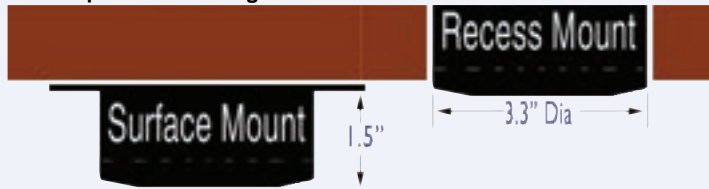

Halogen Puck Lighting Accessories



8 Inch. Cord Set

8" Polarized "T" Adaptor Cord

SKU	Finish	Price
77.46	Black	\$2.11

Touch Dimmer

48" Touch Lead; 10' Power Cord; 12" Female Cord; 300 Watt

SKU	Finish	Price
77.23	Black	\$22.15



8 Ft. Cord Set

8' Cord Set, T-Blade Female Plug & Regular Male Plug

SKU	Finish	Price
77.46.8	Black	\$4.85



3 Ft. Cord Set

3' Cord Set, Female & Male T-Blade Plugs

SKU	Finish	Price
77.43-3	Black	\$3.99



120V Replacement Light Bulb

Replaces the 840.30 & 840.31

SKU	Wattage	Price
840.3.25W	25 Watts	\$3.67

Häfele Loox LED Lighting



Loox LED Driver, 12V Volt DC (For Häfele Puck Lights and Light Strips)

- Includes integrated port for a wide selection of switches
- Includes Driver without main leads
- Parallel connection
- Number of Connections: 6 x Consumer, 1 x Switch



Switch for Loox LED system with 2 meter lead (78 3/4")

SKU	Type	Color	Price
HA.833.89.106	Rocker	Black	\$10.12
HA.833.89.107	Push	Silver	\$12.99
HA.833.89.108	Push	Black	\$12.99



Touch Dimmer Switch for Loox LED System

SKU	Price
HA.833.89.140	\$27.99

Lead For Modular Loox Switches

SKU	Watts	Price	SKU	Length	Price
HA.833.95.000	0-20	\$42.12	HA.833.89.140	500mm (19 1/16")	\$5.79
HA.833.95.002	0-40	\$64.80	HA.833.89.141	1000mm (39 3/8")	\$7.57
HA.833.95.003	0-60	\$70.36	HA.833.89.142	2000mm (78 3/4")	\$7.84

2025 Series 12 Volt Puck lights



LED Puck Light

- Can be recess or surface mounted
- Aluminum housing
- Trim rings, Lead and Other Accessories Sold Separately
- Voltage: 12V
- Wattage: 3.8W

SKU	Color	Price
HA.833.72.351	Warm White	\$34.95
HA.833.72.352	Cool White	\$36.23



Recessed Mount Trim Ring for Puck Lights

SKU	Color	Price
HA.833.72.168	Black	\$3.15
HA.833.72.170	Matte Nickel	\$3.45
HA.833.72.171	White	\$2.20



Surface Mount Trim Ring for Puck Lights

SKU	Color	Price
HA.833.72.160	Black	\$2.20
HA.833.72.162	Matte Nickel	\$2.20
HA.833.72.163	White	\$2.20



Connector Lead for Loox LED lighting

SKU	Length	Price
HA.833.72.880	500mm (19 1/16")	\$3.25
HA.833.72.881	1000mm (39 3/8")	\$3.25
HA.833.72.882	2000mm (78 3/4")	\$6.78



4-Way Extension Lead

- 6500mm (255 29/32")
- For Loox LED puck lights
- 12V
- LED Interconnecting Cable with 4 ports

SKU	Price
HA.833.74.773	\$13.50

Loox Single Color LED Strip Lighting Accessories



2037 Series Loox 5m Flexible LED Light Strips
 Versatile and flexible lighting strips that are perfect for lighting furnishings and furniture! Dimmable and self-adhesive for easy installation.

- 5 Meters long
- 10mm
- 1.2 Watts per foot
- Comes with starter lead

SKU	Style	# of LEDs	Price
HA.833.73.510	Warm White (3000K)	600	\$100.64

Extension Leads

SKU	Length	Price
HA.833.73.782	11 13/16"	\$3.25
HA.833.73.764	19 11/16"	\$2.25
HA.833.73.785	24"	\$2.25

For Extending The Connection Leads of the LED Lights. For Loox LED Lighting. 12V

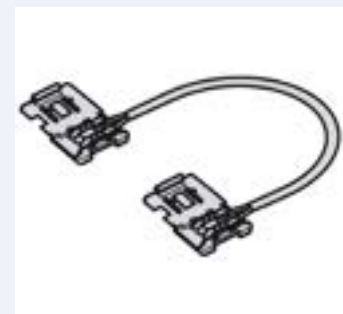

Interconnecting Lead for Loox LED Lighting Strips

3.5A/20AWG, 12V, for 10mm wide ribbon, width: 14mm (5/8"), black, with clips for LED strip light

SKU	Length	Price
HA.833.73.767	50mm (2")	\$3.99
HA.833.73.768	500mm (19 11/16")	\$4.05
HA.833.73.769	1000mm (39 3/8")	\$4.10
HA.833.73.770	2000mm (78 3/4")	\$6.35

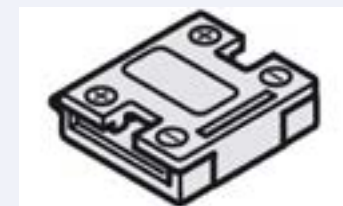

Connector For Loox LED Lighting Strips

SKU	Price
HA.833.73.731	\$1.90



Lead for Loox LED Lighting, Male Plug

Lead with 12V Plug System and Clip, for Loox LED Strip Light

- 12V
- 10mm
- Plastic
- Black

SKU	Length	Price
Male Plug		
HA.833.73.778	100mm (4")	\$4.05
HA.833.73.739	2000mm (78 3/4")	\$6.99
Female Plug		
HA.833.73.779	100mm (4")	\$4.05

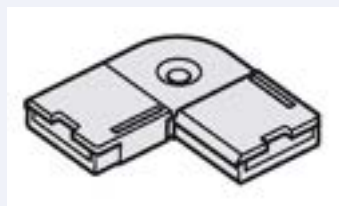

Corner Connector For Loox LED Lighting Strips

SKU	Price
HA.833.73.733	\$1.94

Loox RGB LED Strip Lighting Accessories



2016 Series Loox 5m RGB Flexible LED Light Strips

- 5 Meter long rolls
- RGB Multi-Color
- 12mm width
- 150 LEDs
- 2.16 Watts per foot
- Comes with starter lead

SKU	Price
HA.833.73.450	\$179.63



Color Mixer With 4-way Distributor for Loox LED RGB Strip Lighting

- Maximum: 30 W
- Maximum of 10 color mixers controlled with 1 remote within a radius of 15m (49").
- RGB remote and mixer must be paired for normal operation.
- Includes 1 RGB Color Mixer with 2m Lead and a 4-Way Distributor with .3m Lead

SKU	Price
HA.833.74.802	\$37.39



Interconnecting Lead with Clip, for Loox LED RGB Strip lighting

SKU	Length	Price
HA.833.74.766	50mm (2")	\$4.33
HA.833.74.767	500mm (19 11/16")	\$3.25
HA.833.74.768	2000mm (78 3/4")	\$3.25



Lead for Loox LED Lighting

- Main lead for Loox LED 2014 / 2016
- For Connecting to Color Mixer
- Ribbon Driver Connection

SKU	Length	Price
HA.833.74.745	4000mm (157 1/2")	\$4.80
HA.833.74.764	2000mm (78 3/4")	\$4.80



Connector For Loox LED RGB Lighting Strips

SKU	Price
HA.833.74.761	\$3.25



Corner Connector For Loox LED RGB Lighting Strips

SKU	Price
HA.833.74.760	\$3.25

Abrasives	39	FastCap 3rd Hand	68	Pullout Pilasters.....	103
Accessories	86	FastCap Cover Caps	38	Pullouts	103
Adhesive & Tapes	42	Fastedge.....	38	Router & Saw Accessories	73
Appliance Garage Kits	102	Filler/Pullouts	99	Screws	46
Appliques & Medallions	31	Fillers & Pullouts	90	Senco Staplers & Nailers	82
Appliques & Medallions	32	Fillers & Pullouts	97	Senco Staples and Nails	52
Appliques & Medallions	34	Filler Waste Pullouts	101	Shoe Storage	108
Ballbearing.....	10	Floating Shelves.....	62	Sidemount Ballbearing.....	8
Bed Hardware.....	55	Foot Rail System	65	Sliding Door Hardware	63
Bits	78	Freud Circular Saw Blades.....	77	Spaceballs & Synergy Panel Spacers	89
Blue Bear Concrete Treatments	86	Freud Industrial Router Bits	78	Specialty Storage	92
Blum AVENTOS Lift Systems.....	12	General Finishes®	85	Specialty Storage	97
Bolts	44	Glass Doors/Mirror/Panel Hardware ..	54	Specialty Storage	99
Brackets & Shelf Supports	59	Glue & Heavy-Duty Adhesive	41	Specialty Storage	102
Cabinet & Mailbox Locks.....	58	Grommets.....	53	Stealth Lock.....	58
Cast Metal Pulls & Knobs.....	25	Häfele Loox LED Lighting	114	Steel Arch Pulls	29
Charging Drawer	110	Hampers.....	108	Steel Bar Pulls	29
Clamps	73	Heavy-Duty Sidemount.....	10	Swivel Hardware	54
Cleaners & Lubricants	74	Hidden Fasteners	44	Table Hardware	57
Closet Rods	107	Inserts.....	44	Tambour	102
Closet Rods	108	Island Legs & Turnings	35	Tie Racks & Belt Organizers	107
Closet Storage Pullouts	108	Island Legs & Turnings	36	Tresco Lighting.....	111
CMT Hole Saws.....	76	Jigs & Handle Installation Guides.....	29	Under Cabinet Lighting	113
CMT Oscillating Blades.....	75	Jigs & Installation	29	Unfinished Wood Knobs	29
Columns & Pilasters.....	34	Kitchen	100	Veneer Sheets	37
Compost Container Pullouts.....	95	Laminate Tools.....	79	Wall Anchors & Hangers.....	45
Concealed Hinges	17	Lazy Susans	94	Wall Beds.....	55
Concrete Restoration	87	Lazy Susans	97	Waste Pullouts	95
Connector Fittings	46	Leg Levelers	53	Waste Pullouts	98
Contractor Router Bits	76	Light-Duty Sidemount Ballbearing	11	Waste Pullouts	103
Corbels & Supports.....	31	Lighting Accessories	110	Water-Based Stains & Paints	84
Corbels & Supports.....	34	Mon Reale Mouldings.....	33	Water-Based Top Coats & Undercoats	85
Corbels & Supports.....	35	Mouldings & Corbels.....	32	Wire Pulls.....	28
Cutting Boards & Butcher Blocks	103	Nail and Staple Guns.....	81	Wooden Furniture Feet.....	35
Decorative Hinges	15	None-Slip Mats.....	99	Wood Fillers	87
Decorative Pulls & Knobs.....	26	Nuts & Washers	44	Wood Hoods.....	105
Docking Drawer Blade Series.....	109	Office & Media Storage	57	Wood Range Hoods & Ventilators	104
Door Parts & Accessories	16	Oil-Based Stains & Top Coats	85	Wood Restoration	87
Drivers and Driver Bits	51	Ornamentally Embossed Mouldings	33	Wood Treatments.....	86
Edgebanding	37	Pants Rack	108		
Electronic Accessories.....	110	Plugs, Dowels & Pegs	88		
Ent. Center Door Hardware	61	Pocket Hole Tools.....	72		
European Epoxy	5	Pullout Pilasters.....	92		

Interested in other products from CSH®? Check out the CSH® Section 1 MFG Catalog!

Featuring E-Glide, Quiet Glide® and Putnam Rolling Ladders, Quiet Glide® Rolling Doors, the Invisidoor®, Meadow Lane™ products and more!



ROLLING LADDERS • ROLLING DOORS • INVISIDOOR



2022 Catalog

Section 1



Scan the QR code above
with your mobile device
to view the Section 1
digital catalog!

To obtain a physical copy of the 2022 Catalog
Section 1 or Section 3 - please call our Customer Service Team
at **262-375-7960** and provide your address.

CABINET CATALOG



Galaxy Indigo
pg. 16

Scan the QR code below
with your mobile device
to view the Section 3
digital catalog!

2022 Catalog

Section 3

Interested in cabinets from CSH®?

Check out the CSH® Section 3 Cabinet Catalog!

Featuring JSI Cabinetry®, Legend Cabinetry®, Fabuwood® and more!





cshardware.com

262-375-7960

Fax: 262-375-7970

N169W21008 Meadow Ln,
Jackson, WI 53037

Custom Service Hardware is committed to providing our customers with quality products from **brands you know and love** at great prices with excellent customer service.

CSH will help you take your vision for any project and make it a reality.



HÄFELE

 **FastCap®**

 **REV-A-SHELF**
Innovation through Organization™

 **blum®**

 **Kreg®**

 **SUGATSUNE**

 **Hettich**